

BROADCAST NEWS

TRAVELING
WAVE ANTENNA

VOL. No. 94 APRIL 1957



Planning a Radio Station?

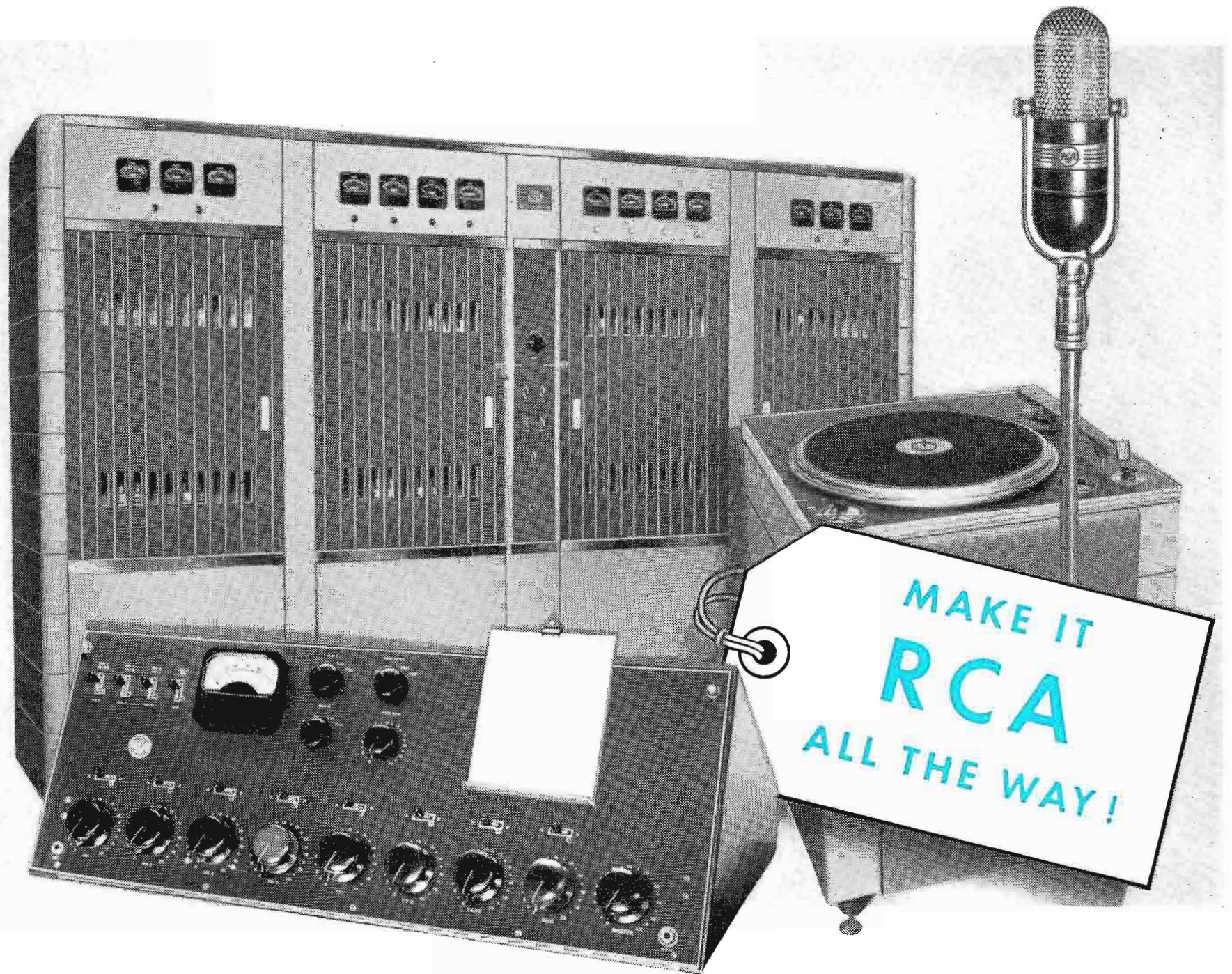

You'll benefit by using this single source of equipment and experienced assistance

For your complete equipment package, for help in planning, and for technical service—RCA can give you everything you need. From RCA you can get a full line of equipment—from microphone to antenna—designed to fill the widest range of station requirements. The practical assistance of RCA station-trained engineers is available for complete planning of your installation. And through the facilities of RCA Service Company, Inc., you can get technical field service in strategic locations throughout the country.

One source for all your station requirements means faster service and delivery to meet your specialized needs... pre-releasing if necessary. By coming to RCA, all your sources are coordinated automatically—you don't have to make all these time-wasting arrangements yourself. You can get on-air faster... stay on-air longer... reduce costly off-air time. And the many benefits will be reflected in increased profits throughout your entire operation. Why not call your RCA Broadcast Representative today?

RCA . . . your first source of help in station planning



RADIO CORPORATION of AMERICA

Broadcast and Television Equipment • Camden, N. J.

In Canada: RCA VICTOR Company Limited, Montreal

Vol. No. 94

April, 1957

BROADCAST NEWS

published by

RADIO CORPORATION OF AMERICA
BROADCAST & TELEVISION EQUIPMENT DEPARTMENT
CAMDEN, NEW JERSEY

PRICE
In U.S.A. - - - \$4.00 for 12 issues
In Canada - - - \$5.00 for 12 issues

CONTENTS

	Page
RADIO FREE EUROPE'S BROADCAST OPERATION	8
WHER — MEMPHIS' NEWEST RADIO STATION	20
KSTP INSTALLS RCA 50-KW AM AMPLIPHASE TRANSMITTER	26
UNIVERSITY OF GEORGIA TO INSTALL EDUCATIONAL TV	29
WISH AND WISH-TV, INDIANAPOLIS, INDIANA	30
TRAVELING WAVE ANTENNA	44
NARTB'S ENGINEERING DEPARTMENT	52
NARTB CONVENTION PREVIEW	54
RCA REPRESENTATIVES AND TERRITORIES	56
AGC AUDIO PROGRAM AMPLIFIER	60
A NEW 2 x 2 SLIDE PROJECTOR FOR TELEVISION	64
HOW TO GET TOP PERFORMANCE FROM THE TK-21 VIDICON FILM CHAIN	74

GETTING THE MOST FROM



If the Picture "Pops" It Has What It Takes!

Many a good film commercial has been ruined by a poor presentation "on-air." If the picture "pops" out at you, has sparkle and dimension, you know it's good. With modern RCA Film Equipment you can expect and get the highest quality reproduction and long term reliability in operation.

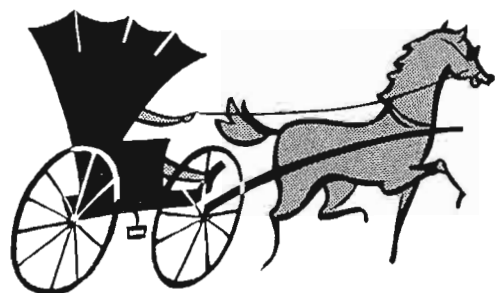

P.S.

HOW LONG SINCE
YOUR STATION'S
FILM ROOM
WAS MODERNIZED?

YOUR FILM DOLLAR

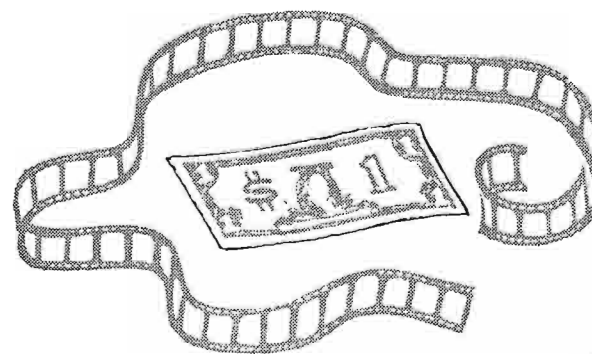

How to Get the Kind of Picture Quality that Advertisers Want

There are two ways to increase the quality of your film programs:

- (a) By using Vidicon film cameras
- (b) By using professional projectors.

Vidicon cameras give you sharp, clear, virtually noise-free pictures of live picture quality. The Vidicon will show every detail that is on the film. For example, night scenes are much clearer with new Vidicon cameras than with older Iconoscope equipment. Vidicon film cameras have *ideal* tone or gray scale range for high quality reproduction of film. A remote light control permits the RCA Vidicon camera to be adjusted to optimum operating conditions at all times.

Professional RCA projectors are another requirement for high picture quality. Professional film projectors provide a rock-steady picture, free from jump and jitter, as well as high fidelity sound. Precise optics in the RCA film and slide projectors assure evenness of illumination and excellent resolution.

Whether you are a station executive, program sponsor or agency man, you'll be helping the cause of good film programming by advocating the use of up-to-date film room equipment. Ask the RCA Broadcast Representative to show you our new film manual "Planning TV Film Facilities for Color and Monochrome."

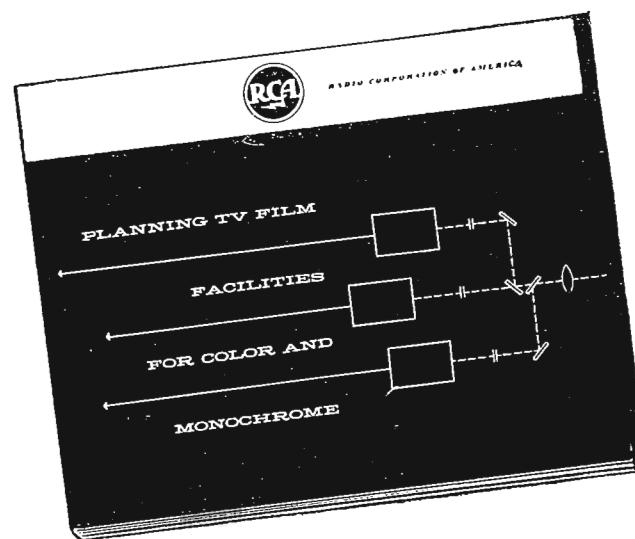

Tmk(s) ®

RADIO CORPORATION of AMERICA

BROADCAST AND TELEVISION EQUIPMENT

CAMDEN, N. J.

In Canada: RCA VICTOR Company Ltd., Montreal

RCA AMPLI

RCA Ampliphase RCA

**50-KW AM
AIR COOLED!**

**New RCA 50-kilowatt
AM Transmitter BTA-50G**

**DESIGNED WITH
AMPLIPHASE MODULATION**

HOW IT WORKS

The "Phase-to-Amplitude" system, in the RCA Ampliphase transmitter, is one in which the RF signal is phase modulated by audio intelligence at a low level. This signal is then amplified via separate high-gain class "C" amplifier channels to the desired power. The outputs of the separate channels are then combined through a suitable network into a resultant amplitude modulated signal. Basic circuit details are illustrated in the block diagram at the right, showing the exciter-modulator, and the intermediate and power amplifier stages.

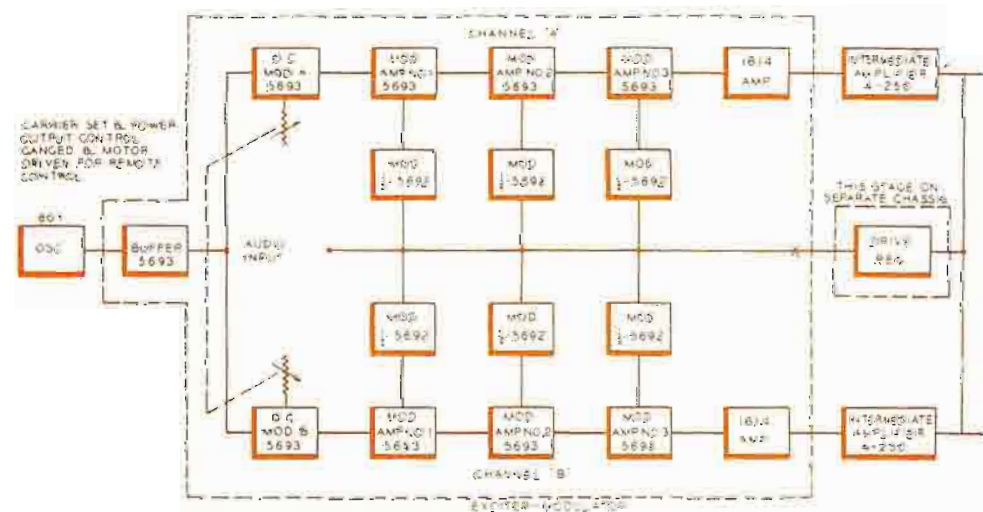

SIMPLIFIED BLOCK DIAGRAM—BTA-50G TRANSMITTER

PHASE

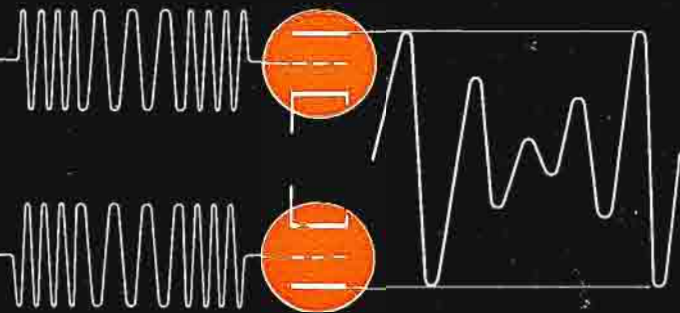

A new concept in AM Broadcasting!

... introduced in RCA's revolutionary 50-KW AM transmitter

Here is the most significant forward step in AM transmitters since RCA introduced high level modulation—an entirely new 50-KW transmitter using Ampliphase Modulation. Newest and finest in RCA's long line of distinguished AM transmitter designs, it is further proof of RCA leadership in the broadcast equipment field.

Ampliphase cuts transmitter floor space and operating costs by substantial margins. The BTA-50G is housed in four cubicles. It does away with half of present power tubes . . . along with bulky components such as modulation transformers,

reactors and accessories. It requires no underfloor trenches, costly water cooling systems, external blowers. And there's no lost air-time—because the 50-KW Ampliphase is remarkably easy to install while your present transmitter is in operation. Then, in most cases, you may keep your old unit as a stand-by.

For complete technical details . . . and for information on the surprisingly low price . . . call your RCA Broadcast Sales Representative. In Canada, write RCA VICTOR Company Limited, Montreal.

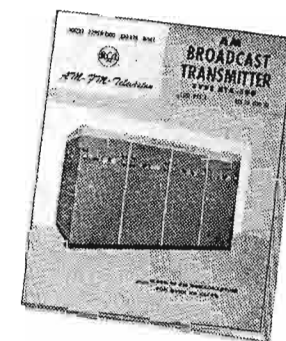

FACTS ABOUT RCA'S NEW 50-KW AM

- Takes less than 80 square feet of floor space. No underfloor trenches required.
- Lowest operating cost of any 50-KW AM transmitter.
- Half the tube cost of other 50-KW AM transmitters.
- Uses famous Long-Life RCA 5671 P.A. tubes.
- No Modulation transformer required.
- Completely air-cooled with internal blowers—no air intake ducts necessary.
- Low distortion, excellent frequency response.
- Splatter-free modulation provided by new Ampliphase design.
- Designed to permit remote-control operation.
- New simplified circuitry. Extremely stable operation.

PIONEERS IN AM BROADCASTING FOR OVER 25 YEARS



RADIO CORPORATION of AMERICA

BROADCAST AND TELEVISION EQUIPMENT

CAMDEN, N. J.

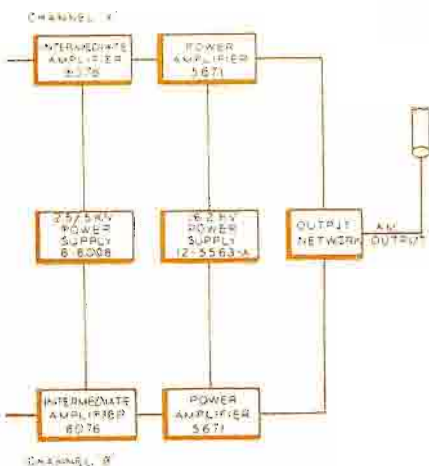

RCA Vidicon



TYPE TK-15 VIDICON
CAMERA

7-INCH BUILT-IN VIEWFINDER

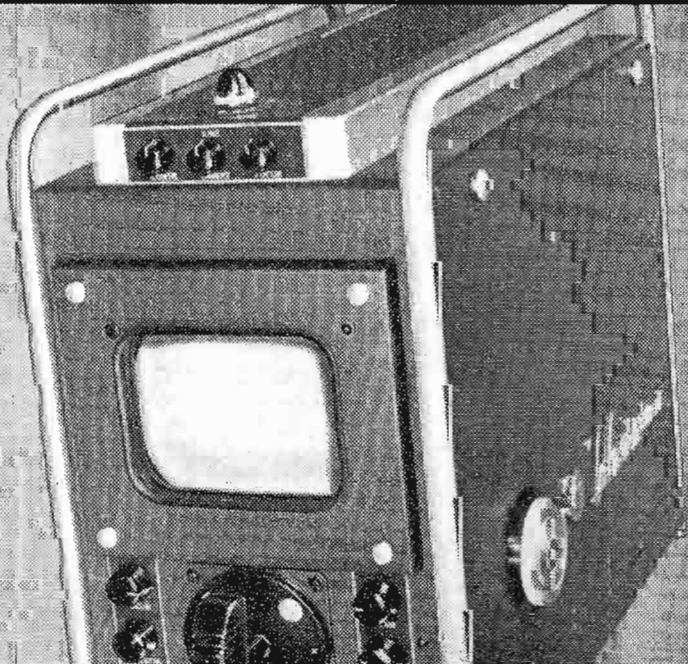

VERTICAL CHASSIS CONSTRUCTION

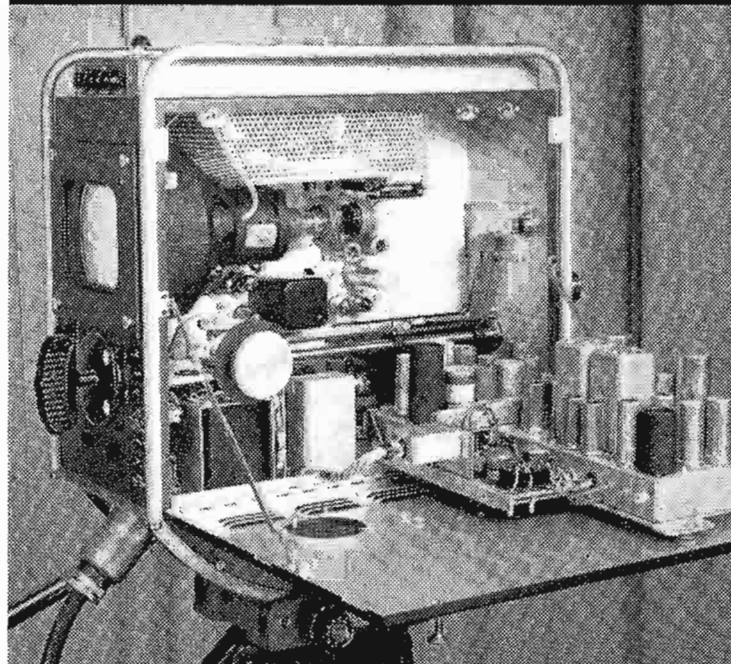

CAM OPERATED FOCUS MECHANISM

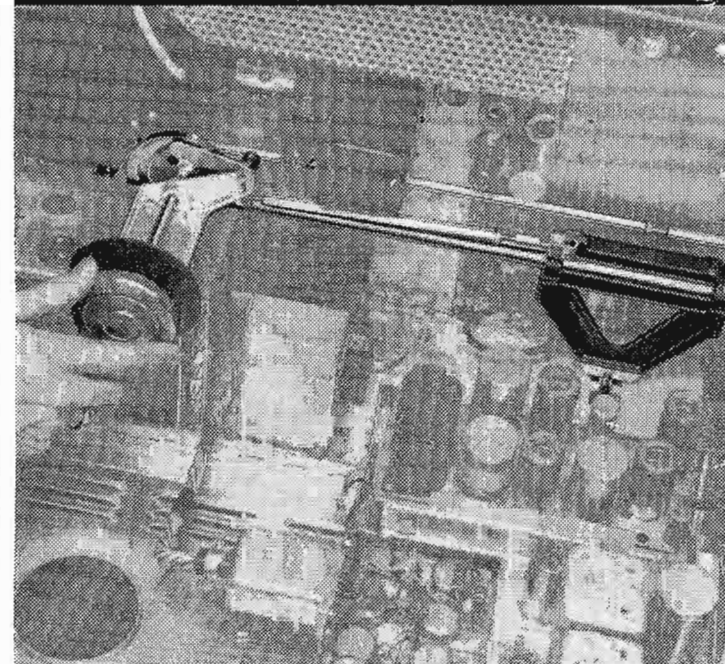

Studio Camera for Live Broadcast Use

Camera Design Combines Broadcast Equipment Standards with Operating Economy of the Vidicon Tube

For the first time the economy of vidicon operation is available in a live studio camera designed to Broadcast standards. RCA Broadcast engineers have incorporated the latest in techniques and circuitry into the TK-15 Vidicon Camera for TV studio use. The result is a camera which offers the same kind of operating convenience as other RCA Broadcast cameras. It provides high-quality pictures for flip card commercials, live news programs and other scenes on which the light level is adequate for vidicons.

*See your RCA Broadcast Sales Representative for additional information; or write for illustrated brochure containing complete particulars.
In Canada: write RCA VICTOR Company Limited, Montreal.*



Tmk(s) ®

RADIO CORPORATION of AMERICA

BROADCAST AND TELEVISION EQUIPMENT

Camden, N. J.

These Advanced Features:

- EXCELLENT PICTURE QUALITY WITH PROPER LIGHTING
- BUILT-IN 7" VIEWFINDER, 4 LENS TURRET FOR BROADCAST TYPE OPERATION
- QUICK AND PRECISE OPTICAL FOCUS ASSURED BY NON-LINEAR FOCUS MECHANISM
- SIMPLIFIED SET-UP AND OPERATION PROVIDED BY FEEDBACK STABILIZED CIRCUITRY
- 14-INCH RACK-MOUNTED OUTPUT AMPLIFIER MAY ALSO BE HOUSED IN FIELDCASE FOR REMOTES
- COMPLETE ACCESSIBILITY OFFERED BY VERTICAL CHASSIS CONSTRUCTION WITH HINGED SUB-CHASSIS

RADIO FREE EUROPE'S Broadcast Operation

by PAUL A. GREENMEYER,
Managing Editor, BROADCAST NEWS

Part One
RFE Installations
in Germany

This article, we believe, will be of interest to broadcasters not only because Radio Free Europe has been in the headlines recently but also because American personnel supervise the operation of this king-size radio system. Broadcasters who have toured the RFE installations in Europe have found them just as interesting as we did on our trip some months ago. At that time we met quite a few broadcast engineers from the U. S. A. who are in key supervisory positions for the RFE in Portugal and Germany. These engineers and their families were quite enthusiastic about their experiences outside the States.

* * *

Radio Free Europe was organized in December 1949, to broadcast to the Communist-dominated satellites in Central and Eastern Europe. From transmitters in Germany and Portugal, RFE beams news, information, commentary and a variety of other programs to Poland, Czechoslovakia, Hungary, Bulgaria and Rumania. For twenty hours a day, programs are transmitted to all major groups within these countries. Political, economic and spiritual issues are stressed, with the primary purpose of giving the true facts about events in the listeners' own country and the free world. Twenty-two powerful transmitters and an extensive radio relay system are employed to accomplish this goal. Sources of information for the news programs include a huge monitoring system for listening in on Iron Curtain stations, a staff of correspondents and a group of evaluators. A staff of devoted, locally well-known exiles write the programs and act as talent and announcers to give vitality and validity to the Voice of Freedom broadcasts. The management of RFE, and supervision of technical operations, is American.

Appropriately enough, on July 4, 1950, in the woods of Lampertheim, near Frankfurt, Germany, the Voice of Freedom was born. At that time the National Committee for a Free Europe, organized by a group of public-spirited American citizens, first started beaming local language programs to peoples in the satellite countries. With the support of contributions from interested Americans to the Crusade for Freedom, a mobile RCA 7500-watt transmitter, studio and supporting facilities housed in several trailer vans had been procured. In 1951 five additional high-power radio transmitters were added at fixed locations in Germany. Then the mobile transmitter



Schubertova and Sasek, Czechoslovak broadcasters for RFE, produce "In the Mood", a cultural program of music and poetry.

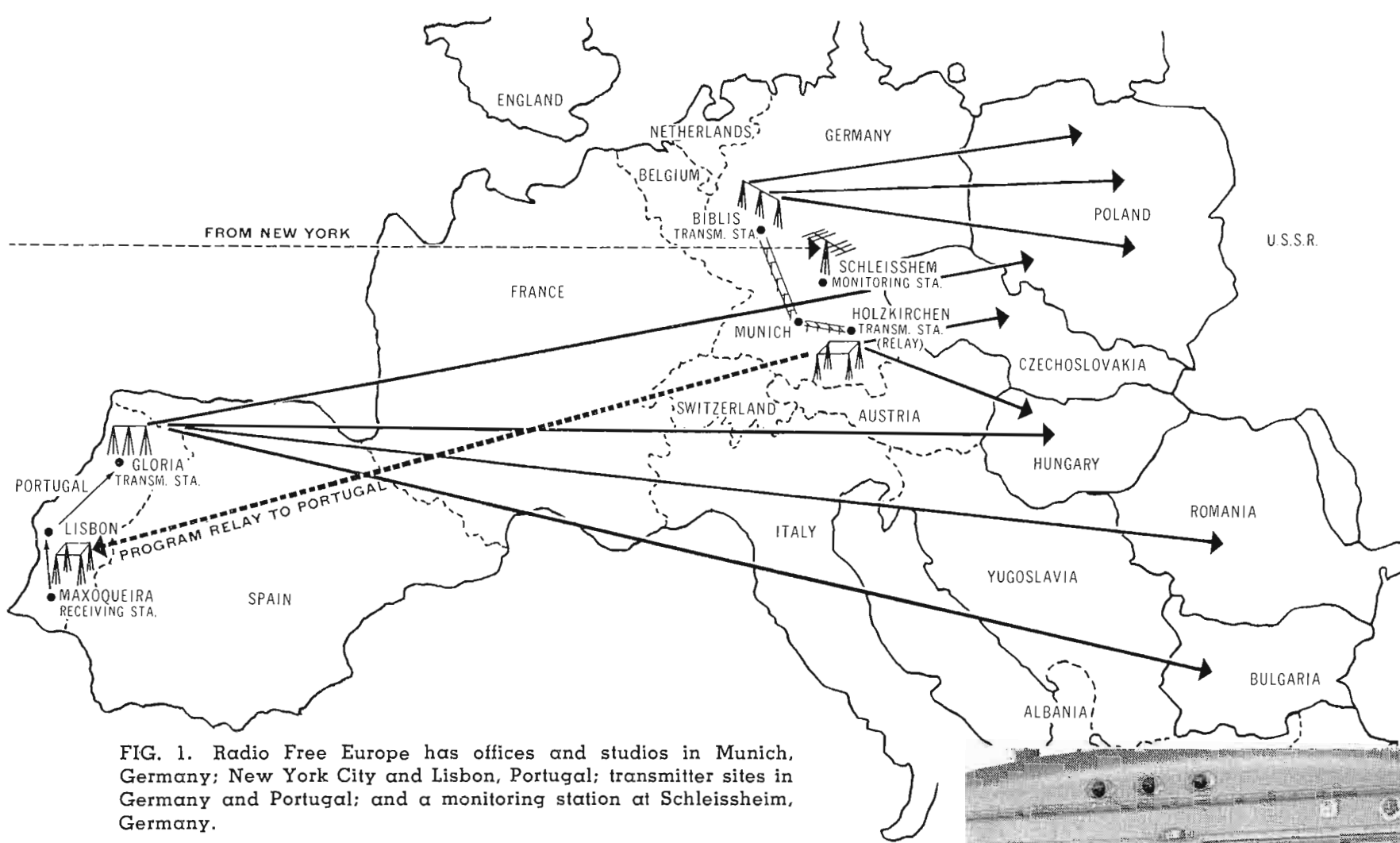

FIG. 1. Radio Free Europe has offices and studios in Munich, Germany; New York City and Lisbon, Portugal; transmitter sites in Germany and Portugal; and a monitoring station at Schleissheim, Germany.

was transported to Portugal, where it became the first transmitter at what is now one of the largest transmitting plants in the world.

New York Headquarters

New York City is the news center and administrative headquarters for the RFE operation. Under Mr. W. J. Convery Egan, Director of RFE, an executive staff heads programming, policy, information, administration, engineering and supporting activities. Controls for all phases of the operation reside here.

Facilities at New York include several studios for program preparation, since about 10 per cent of programs originate here. All programs are produced in the languages of the target countries. This material goes to RFE in Europe via Press Wireless or is put on tape and flown over. The programs coming out of New York are primarily international commentaries and news, plus some music and entertainment programs.

Under Mr. Claude M. Harris, Director of Engineering, technical policy is determined, plans are drawn up, and equipment and maintenance supplies are purchased. Also, together with the Munich office, studies are made of monitoring reports, sunspot activity and ionospheric conditions in order to select the best frequencies for use in the transmitting schedules, which are revised periodically.

Two 2-way radio teletype channels are in use Monday through Saturday via Press Wireless for six hours daily to send news, scripts, and program material from New York to Munich. In the other direction, operational data, monitoring information, and scripts are transmitted. In addition there is an international teletype circuit via RCA Communications for sending administrative messages.



W. J. Convery Egan, Director of Radio Free Europe.



Claude M. Harris, Director of Engineering for Radio Free Europe.



Russell E. Geiger, Assistant Director of Engineering for Radio Free Europe.

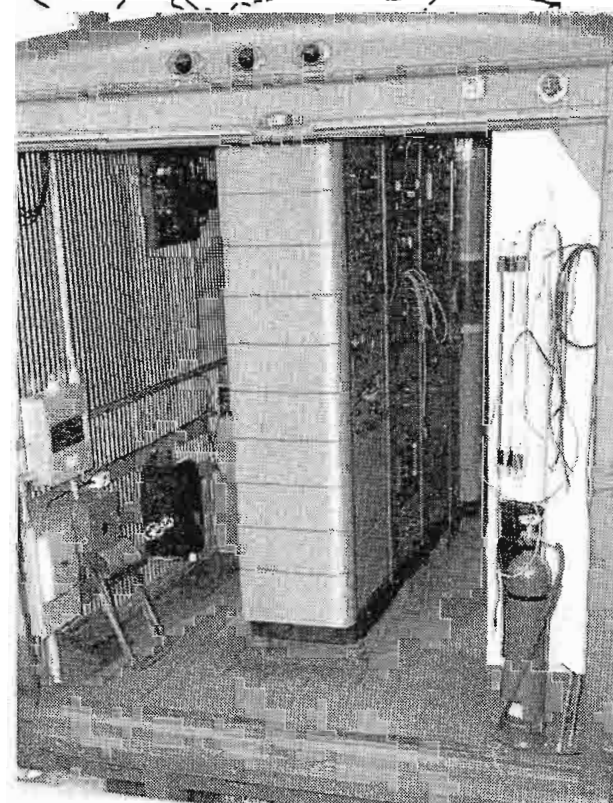

FIG. 2. Close-up of transmitter unit of original RFE radio station procured from RCA which is installed in seven tractor-trailer units.

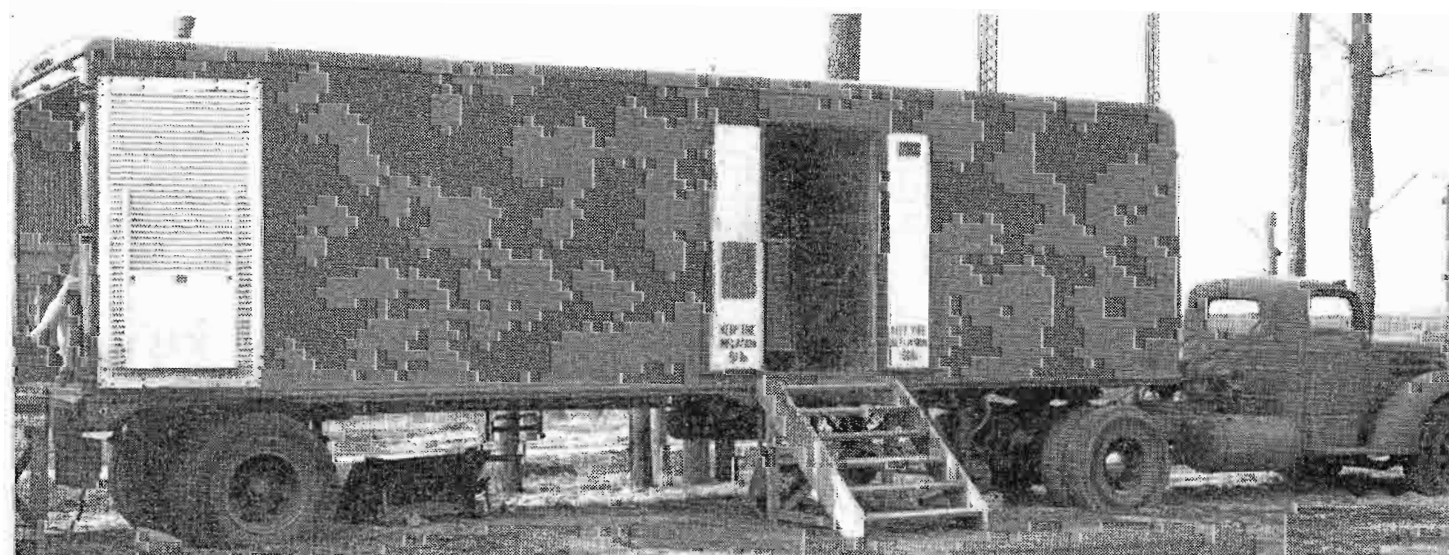
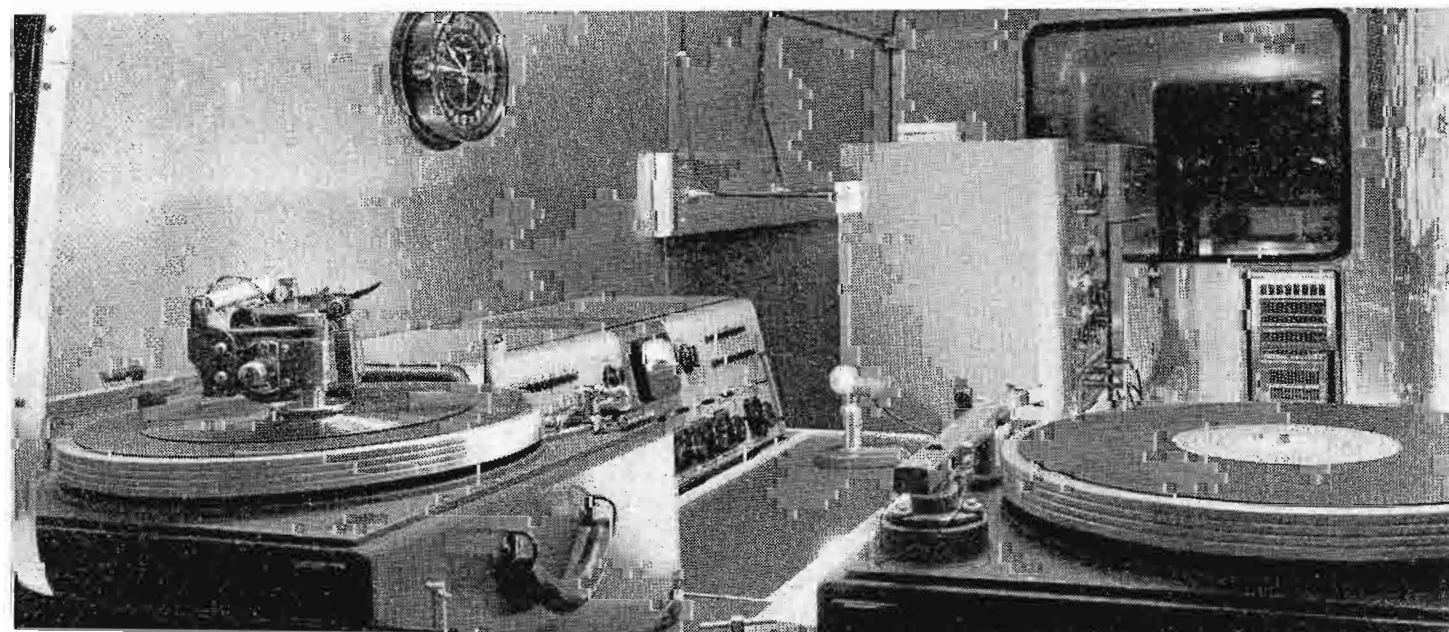

FIG. 3. Original RFE transmitter in the woods of Lampertheim, near Frankfurt, Germany. Here the "voice of freedom" was born on July 4, 1950.

FIG. 4. Original RFE radio studio and control room on wheels, in Germany. It occupied one tractor of the seven-tractor broadcast station.



Developing the Program Format

The Mission

RFE is private initiative and enterprise applied to fighting Communism, and in doing so, protecting the security and liberty of the United States. Many learned during the war that the most potent force is spiritual; that the appeal to men's minds produces a dedication which surmounts every trial and test until victory is won. To toughen, strengthen and fortify such dedication to the cause of freedom—without inciting violence or bloodshed—is the mission of Radio Free Europe.

The Technique

In order to carry out a program of such scope, RFE realized that a new approach, utilizing original techniques, should be adopted for its strategic target area centered between the great land mass of the Soviet Union and Western Europe. In a short time, experimentation proved that RFE could most effectively deliver its message if it spoke with the voice and authority of freedom-loving exiles who had escaped from behind the Iron Curtain. Therefore, RFE developed what is, in

effect, a network of stations: The Voice of Free Czechoslovakia, Free Hungary, Free Poland, Free Rumania and Free Bulgaria.

Programs cover a range of subjects equal to any domestic radio station. Special programs are designed for youth, workers, intellectuals, farmers, women, scientists, military men and even Communists. Of primary importance is RFE's practice of providing truthful news and information for its listeners. News and information that is suppressed or delayed by the regimes is broadcast daily by RFE, so that the people may know the unvarnished truth. The Voice of Free Poland becomes, in effect, the *true* Radio Warsaw when RFE's Polish staff speaks to their listeners as friends and fellow countrymen.

News and Information Service

RFE maintains a staff of correspondents wherever news may first become available. In Munich, this steady stream of information is evaluated by trained analysts. Communist newspapers and periodicals from the target countries are studied

daily, and RFE monitoring sections listen day and night to at least 35 Communist stations in the satellites and the Soviet Union. To further bulwark news coverage, the RFE Central Newsroom operates on a round-the-clock, seven-day-a-week basis, feeding 250,000 words of Western and satellite news each day to the language desks.

Evaluation and Research

An Evaluation and Research Section compiles a great storehouse of information, on which Programming depends for most of its material. There is a total staff of some 100 persons, engaged in the Evaluation and in the Research and Library subsections.

The first source of material is the sixteen field offices of RFE, some situated close to the Iron Curtain, like the Austrian and the Berlin bureaus, others at more remote places specially suited for the collection of first-hand information from visitors of satellite countries such as the ports of Hamburg and Istanbul and some in greater or lesser capitals like London, Paris or Stockholm. It is these field offices which provide the live contacts with the popula-

HOW RFE PROGRAMS ARE CREATED

- I. INFORMATION REPORTS
From 15 RFE Bureaus
- II. MONITORING of Regime
Radio Stations and Soviet
and Satellite News Services
- III. NEWS From Wire Services
- IV. NEWSPAPERS, Books and
Magazines



FIG. 5. First-hand report from Czechoslovakia. RFE reporter (right) interviews escapee while his story is recorded on tape for broadcast. Refugees and travelers from behind the Iron Curtain are interviewed regularly.

tion of "captive nations." Reports reach RFE to the tune of something like 1200 a month.

The Evaluators work patiently through the reports, checking them line-by-line against their accumulated knowledge. Apart from factual checks, every Evaluator has to lead a double life—a physical one in Munich, an imaginative one in his own captive country, so that he can instinctively spot anything which is at variance with the picture he has—and keeps fresh through his work—of the country from which the refugee, or visitor, has come. The factual information at his disposal is enormous. Hungarian Evaluation, for example, with a staff today of two evaluators and three researchers, has built up a registry of 56,000 individual or biographic cards, and 20,000 "collective cards," which give a detailed breakdown of individual factories, kolkhozes, Party units and so forth, from the top down to the smallest cell.

RFE Monitoring

The Monitoring Section constitutes the ears of RFE's Program Desks. By listening to the home transmissions of radio stations

behind the Iron Curtain—that is, the broadcasts which the Communist regimes beam to their own people—RFE gleans a great deal of information about the internal situation of the satellite countries, the propaganda tactics of the Communists and, by reading between the lines, the reaction of the people.

It is one of the wonders of modern engineering skill that so many of the self-revealing local broadcasts are heard, because in most cases the Iron Curtain stations are not concerned with reaching beyond their own borders—whereas American equipment and techniques have enabled RFE to "pull in" stations from great distances. This is of great importance because the local flavor of these broadcasts spell something to the exiles who are working in Munich formulating the Free World's answer to them.

At present 35 Curtain stations are monitored regularly, 4 to 6 others on a spot basis. In the course of a week 12 languages will be used. The daily intake by aural monitoring reaches 50,000 words and on some heavy days the total monitoring intake (including news services, monitored mechanically) is more than 200,000 words.

Program Schedules

Sufficient programs are prepared for 21 hours of daily broadcasting to Poland, Czechoslovakia, Hungary, and a lesser amount to Bulgaria and Rumania. A typical program day runs from 4:55 a.m. to 12:20 a.m. the following day, a total of 19 hours and 25 minutes. When developments make it necessary or desirable, RFE extends this broadcast schedule and has even run for 24 hours round-the-clock for days at a time. Newscasts are made on-the-hour for ten minutes. Most programs other than news are put on tape prior to broadcasting. At midnight each day a "saturation" effect is achieved by beaming all transmitters on one target.

From Germany and Portugal programs are beamed behind the Iron Curtain by 22 transmitters. During the entire broadcast day all programs are on several frequencies. For example, in Poland a listener can get RFE on eight different channels, seven in Hungary and seven in Czechoslovakia. This makes the task of jamming by the Communists difficult, very expensive and quite impossible to achieve. The opposition uses 1200 jammers in attempting to counteract the RFE broadcasts.



FIG. 6. Information received is carefully processed by staff of evaluation experts, translators, etc. Writer-producer-talent teams transform this source material into 184 hours of original programs weekly.



FIG. 7. The program fare consists of newscasts, political commentaries, group programs, and feature programs. Illustrated here in a Munich studio is a Hungarian newscaster.

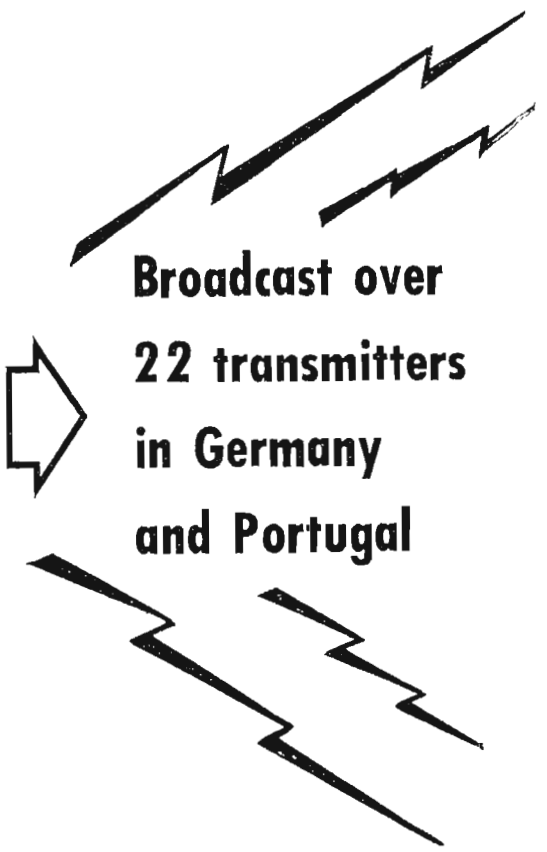

**Broadcast over
22 transmitters
in Germany
and Portugal**

RFE Technical Facilities

Radio Free Europe's physical facilities are scattered over the European map in order to take best possible advantage of differences in propagation paths and conditions. In order to conform to the known short-wave listening habits of the satellite audience, it is considered necessary to broadcast on the 49, 41, 31, 25, 19, 16 and 13 meter bands. With locations in Germany and Portugal, it is possible to present a good signal to most of the target areas on nearly all of the above bands at one time. The listener is thereby assured of a good signal level on each of the short-wave bands capable of propagating a signal.

Antenna Systems

With five specific well-defined target areas to cover, RFE has designed and constructed antenna systems which radiate maximum power at the required horizontal and vertical angles and with optimum conical beam width, thereby insuring the delivery of high-intensity signal levels throughout the target areas. The power

gain of the short-wave antennas varies from 10 times for those relative wide-angle systems located near the target areas to 56 times for those narrow-angle systems located more than 1200 miles from the target areas. Both horizontal broadside curtains and high-gain rhombic antennas are used.

Most of the high-gain curtain antennas are designed for use on two adjacent broadcast bands and many are slewed electrically through twenty degrees azimuthal range so that any target area can be effectively covered with a radiation system tailored to the requirement. In order to achieve maximum flexibility, extensive antenna switching systems have been installed so that transmitters can be directed to any target area.

Frequency Allocations

Propagation experts in New York and Munich study and determine the choice of frequencies for best accomplishing objectives. A schedule of proposed frequency

TECHNICAL FLOW CHART FOR A TYPICAL



FIG. 8. RFE American producer listens as staff talent brings a play, "The Voice of the Turtle," to life at Munich studios. Program is tape-recorded in Production Studio and on day of scheduled broadcast, tape is delivered to Air-shift Studio for the specific language to be used.

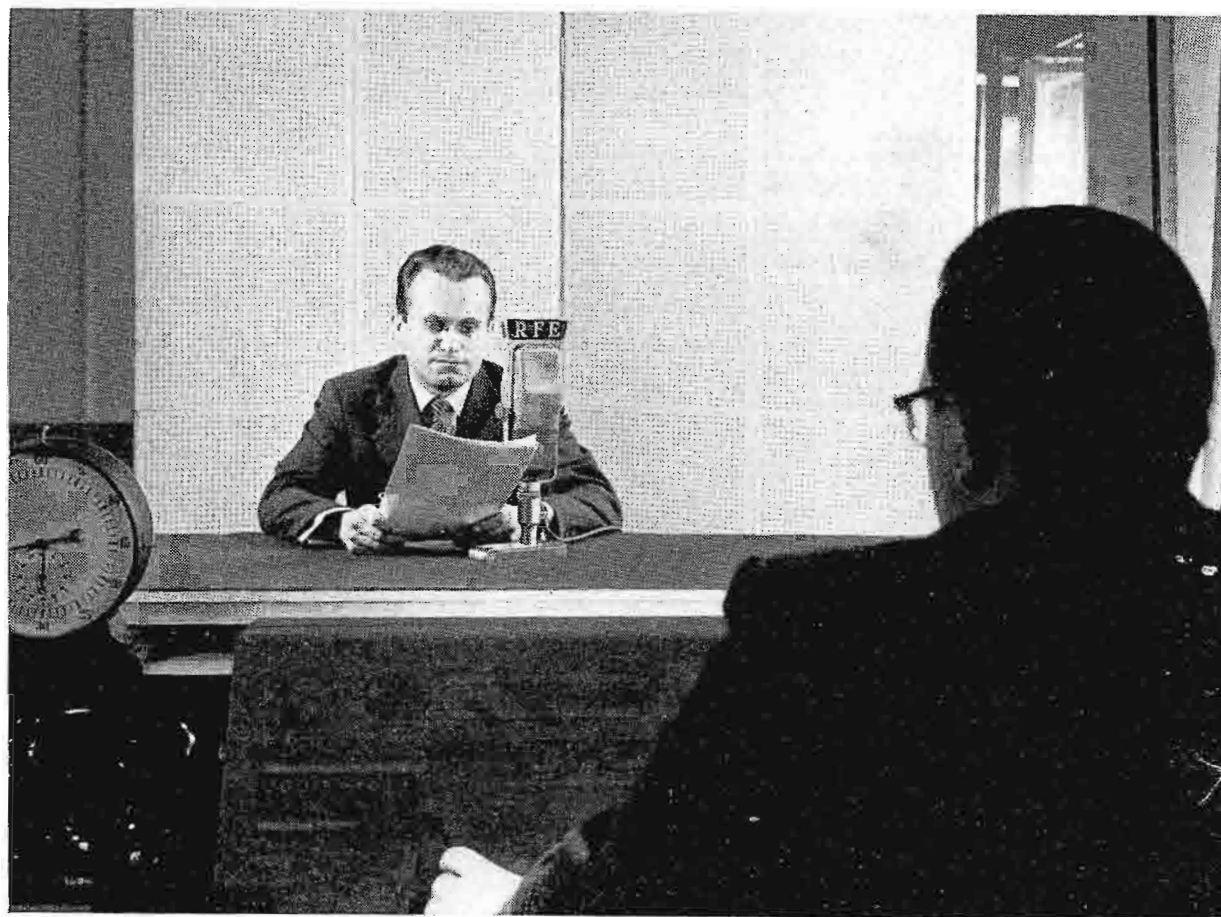

FIG. 9. Newscasters give latest news live every hour on the hour to countries behind the Iron Curtain. . . . Newscasts, and other topical programs, are done live from speakers' rooms (announce booths) adjoining the control room in the airshift studios.

assignments is worked up in Munich and New York for use in Germany and Portugal. After agreement is reached, the schedule becomes effective for a period generally ranging from two weeks to one month.

Relay Transmitters

In the U. S. A., most radio stations are linked together by commercially available program lines, however, in Europe there are no program lines from Germany to Portugal. Therefore, RFE had to devise a system whereby its programs could be relayed by radio. In Germany, six 10,000 watt transmitters were installed which beam programs to Portugal, where they are picked up on triple-diversity receivers and then broadcast to the target countries. In order to obtain the best results over the relay, in case of either jamming or poor propagation conditions, program material is sent over two basic trunk circuits. In other words, the six relay transmitters are split up into two groups of three, each

of which acts as a communication trunk line for relay material. At the receiving terminal the best transmission of the three is selected for broadcast or recording. As many as 84 frequency changes are requested and made per day on these six transmitters in order to maintain the best reception conditions.

Technical Effectiveness

One of the first questions that a thoughtful person asks is, "How effective is RFE? Are they being heard through the jamming?" Let us say that of course RFE encounters jamming on some of the broadcasts, but the natural laws of propagation, plus careful system planning and operation by the RFE engineering staff, prevent the opposition from being wholly successful.

RFE maintains three separate monitor receiving sites, each of which makes two readings per hour on each of the target transmitters throughout the 20-hour broadcast day. Berlin reports on Polish and

Czech transmissions, Vienna on Czech and Hungarian programs, while Istanbul monitors RFE Hungarian, Rumanian and Bulgarian broadcasts. The reception results of each individual station are put into graphic form, which shows at a glance the daily intelligibility of each transmitter over a two-week period.

These reception data are also put into still another form. Each of the hourly readings of all radio stations of each language network are put onto an IBM punch card. From these individual cards an average is made for an entire monthly period, as an example the report summary might read as follows: Of all eight Polish transmitters as monitored in Berlin, the listener could hear the RFE Polish language program at any time of the day or night on one or more frequencies, with an intelligibility and signal strength of "fair" to "good" 92 per cent of the time. Over a period of years it has been found that the average of all language services varies in effectiveness between 85 and 100 per cent.

BROADCAST



FIG. 10. Master control at Munich Studios feeds program signals to transmitters for target countries. (This unit was designed and built by RFE engineers.)

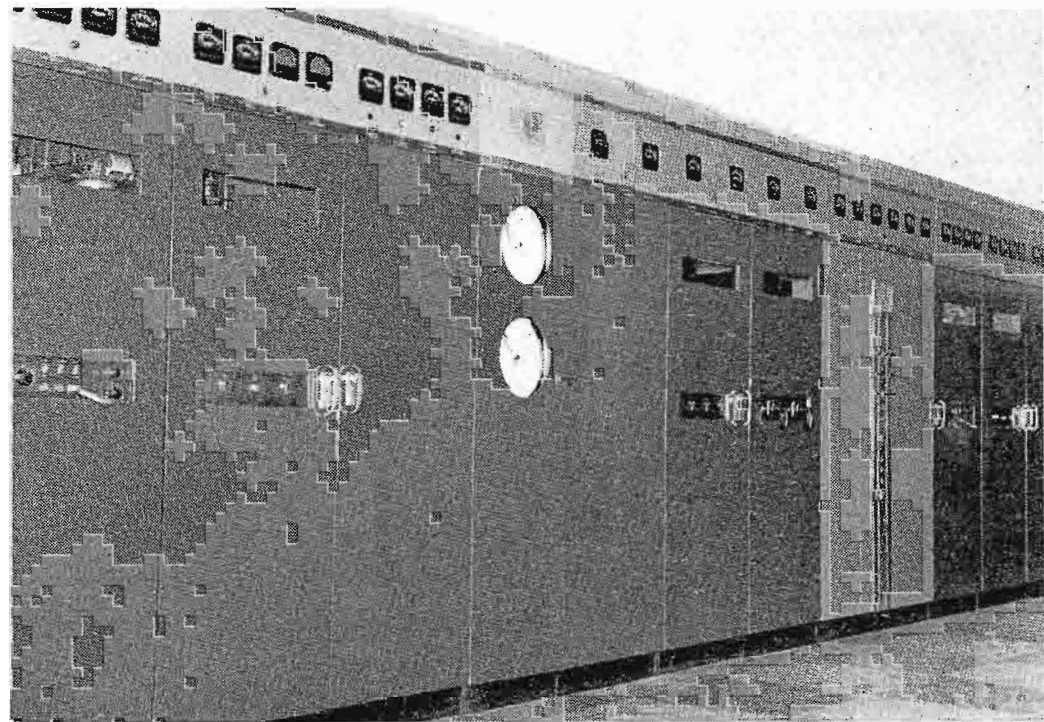

FIG. 11. At transmitter center in Germany nine broadcast transmitters are used. Shown here is part of two RCA 50-kw transmitters used in this area.

FIG. 12. At the transmitter center in Portugal 13 broadcast transmitters are used to beam programs to target countries. Shown here is the main transmitter hall housing eight RCA 50-kw transmitters.



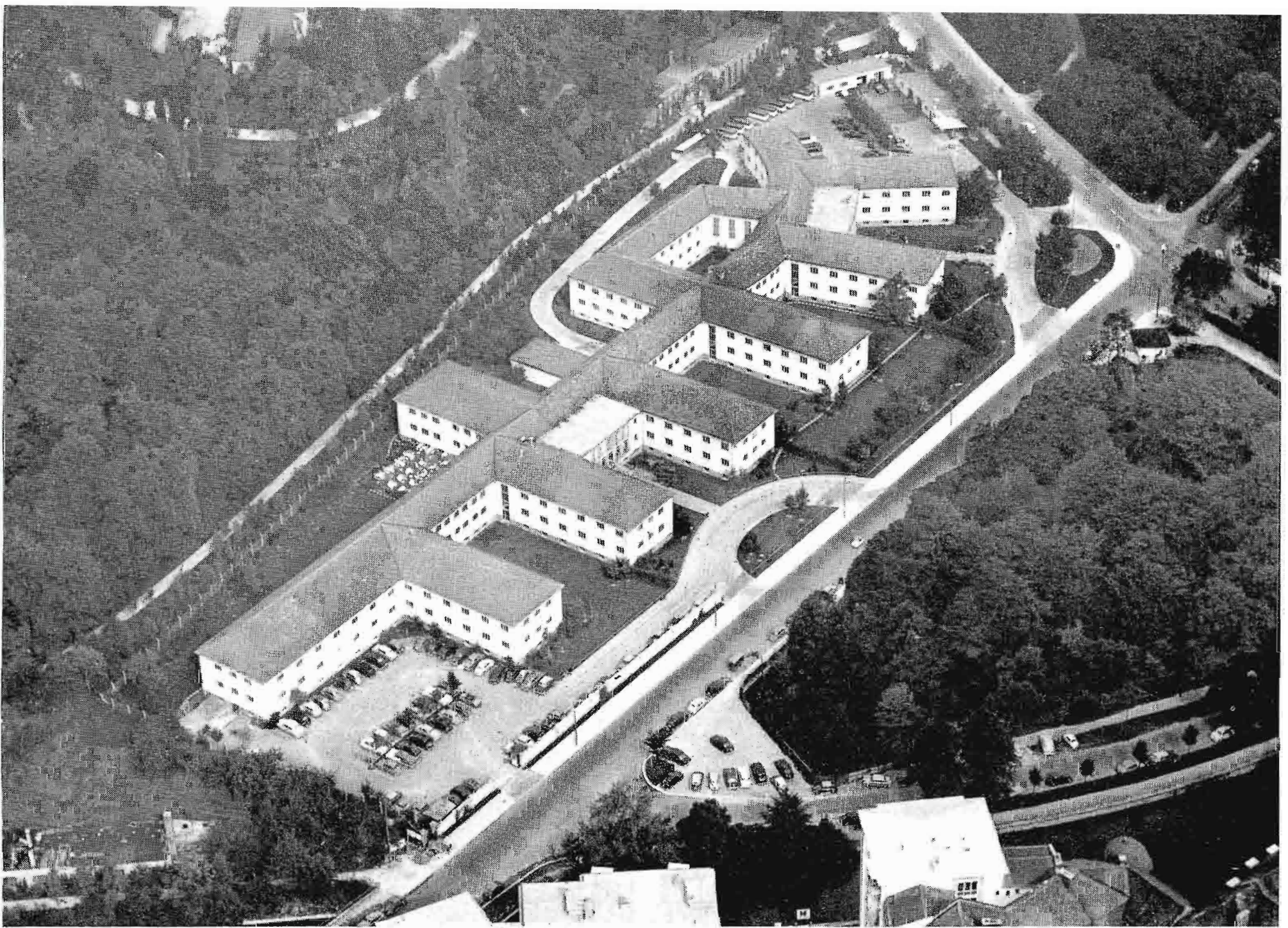

FIG. 13. RFE installation in Munich, which houses 21 studios and 20 control rooms besides monitoring, engineering, programming and administrative facilities. Broadcasts emanate here for Czechoslovakia, Hungary, Poland, Rumania and Bulgaria.

RFE Operations in Munich

In the English Garden section of Munich are located the European headquarters of Radio Free Europe. Here the great bulk of the programs are prepared, while other programs are produced in New York. Here also operations are co-ordinated with Portugal. The RFE headquarters building in Munich houses administration offices, studios, program and monitoring facilities.

The radio equipment for monitoring, relaying and transmitting are located at Schleissheim, Holzkirchen and Biblis, respectively. Schleissheim, some seven miles from Munich headquarters, is the primary listening post of RFE. Here are located the antenna system and sensitive receivers for prying behind the Iron Curtain into centers such as Prague, Warsaw, Sofia and Bucharest. Holzkirchen, 17 miles from Munich, is the home base of the relay system connecting Germany and Portugal, to co-ordinate broadcasts of the same program, via short-wave and medium-wave transmitters in Germany and short-wave transmitters in Portugal. Here is located the 135-kw medium-wave transmitter which broadcasts to nearby Czechoslovakia. Biblis, 200 miles from Munich, is the location of eight powerful transmitters

that beam broadcasts from Germany directly to the target areas.

Technical Monitoring

Monitoring operations at Munich are divided into two phases: Technical and Content. Technical monitoring is an engineering function while Content monitoring is a programming function. The International Shortwave bands of 49, 41, 31, 25, 19, 16 and 13 meters are monitored. Under Mr. Vincent J. Skee, Manager of Technical Operations, a master control room receives all signals from Schleissheim and distributes them to the various content monitoring rooms. In a technical monitoring control room are receivers used by the technical monitor operators engaged in their tasks. Charts are issued at regular intervals showing who is on the air, when, and at what frequency. Sources monitored include BBC, VOA, Armed Forces Network, Western as well as Iron Curtain stations. From these charts "open" frequencies and times are revealed which help provide data for future scheduling of transmitter frequencies. Thus, the technical monitors uncover the open slots into which RFE can insert programs for broadcast to target areas.

Content Monitoring

A typical content monitoring area consists of two rooms equipped with recorders and typewriters as well as the listening facilities. Audio comes from master control into a distribution box at which the content monitor can premonitor the various signals before selecting one for recording.



FIG. 14. Cardinal Spellman is one of the distinguished visitors who annually make pilgrimage to Munich and appear as guest speakers to the radio audience, encouraging both the RFE staff and the audience behind the Iron Curtain.

The content monitor is primarily an editor in a specific language. He is an eavesdropper on what the Communist regime is putting out for local consumption. The information is typed and immediately forwarded to the policy room for use in preparing programs.

Programming

The information gathered by the content monitor enables the political advisory staff to prepare effective programs such as "The Other Side of the Coin." This program refutes the statements put out for local consumption by satellite governments, showing how untruthful they are when compared to official news agency statements. Refugee personnel are the key figures in the program preparation. Around them revolves the successful application of the Freedom Crusade principle. They are usually well-known figures in their own countries and thus establish themselves as reliable commentators. There are 28 of these people at Munich and another 20 or so at the Schleissheim monitoring center specializing in program work for their respective countries.

Munich Studios

There are a total of 21 studios and 21 control rooms in Munich. The studios divide into two general types: Air-shift studios and production studios. The air-shift studios are the "live" studios. (There is one for each language. Air-shift studios connect directly to the transmitter and relay stations through master control room.) Production studios are used for

preparation of the programs—editing of tapes and general preparation work prior to putting the program on the air via the air-shift studio.

There are six air-shift studios in Munich, each of which consists of three rooms: Two speakers' rooms (announce booths) with a control room in between. Each speaking studio is furnished with a table, chair, and Type 77-D or 44BX Microphone. Besides the air-shift studios for each of the four main languages there are two for use in feeding relay programs to Portugal. In addition there is one large studio employed for round-table discussions by large groups, audience participation shows, and larger productions. This houses several booms with Types 44 and 77 microphones as well as the desk mikes.

Twelve production studios are in use at Munich. These are complete with tape recorder-players and editing equipment. Each language group has two production studios at its disposal, leaving two additional ones for special and emergency use.

Program Personalities

It is here in Munich that important personalities from the U. S. A. and all over the world pay frequent visits to studios of the RFE to lend their aid. Leading figures from the entertainment world, important businessmen, government and religious leaders are guest speakers on many occasions. Their appearances before the microphone give additional hope to the imprisoned peoples and incidentally encourage RFE personnel.

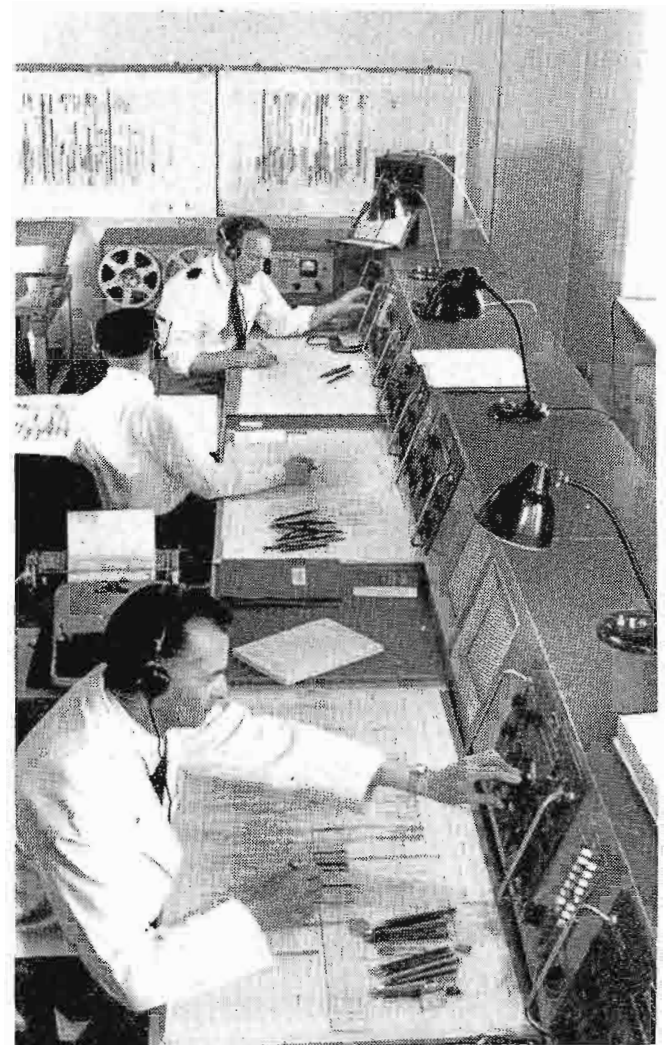

FIG. 16. Technical monitoring at Munich.

FIG. 15. Content monitoring at Munich.

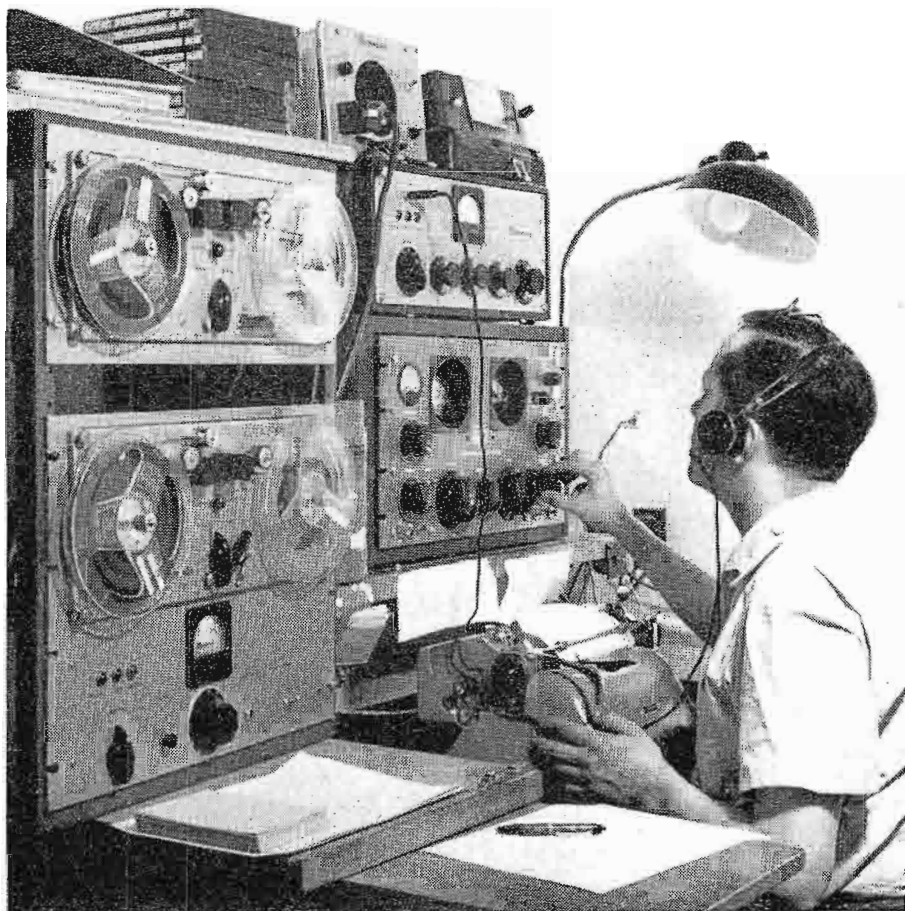
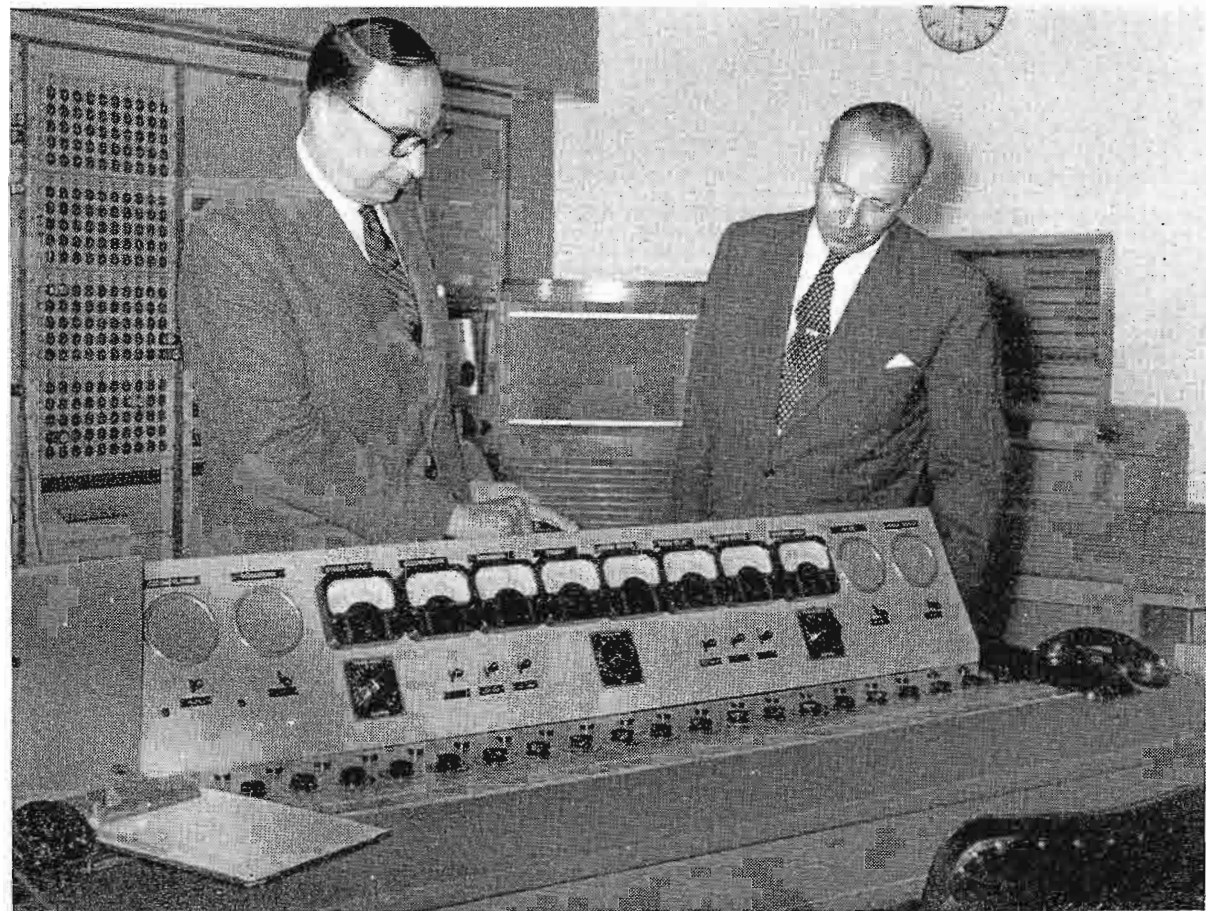

FIG. 17. (Right) George Graveson, Chief Engineer, and (left) Vincent J. Skee, Manager of Technical Operations in Master Control Room at Munich.



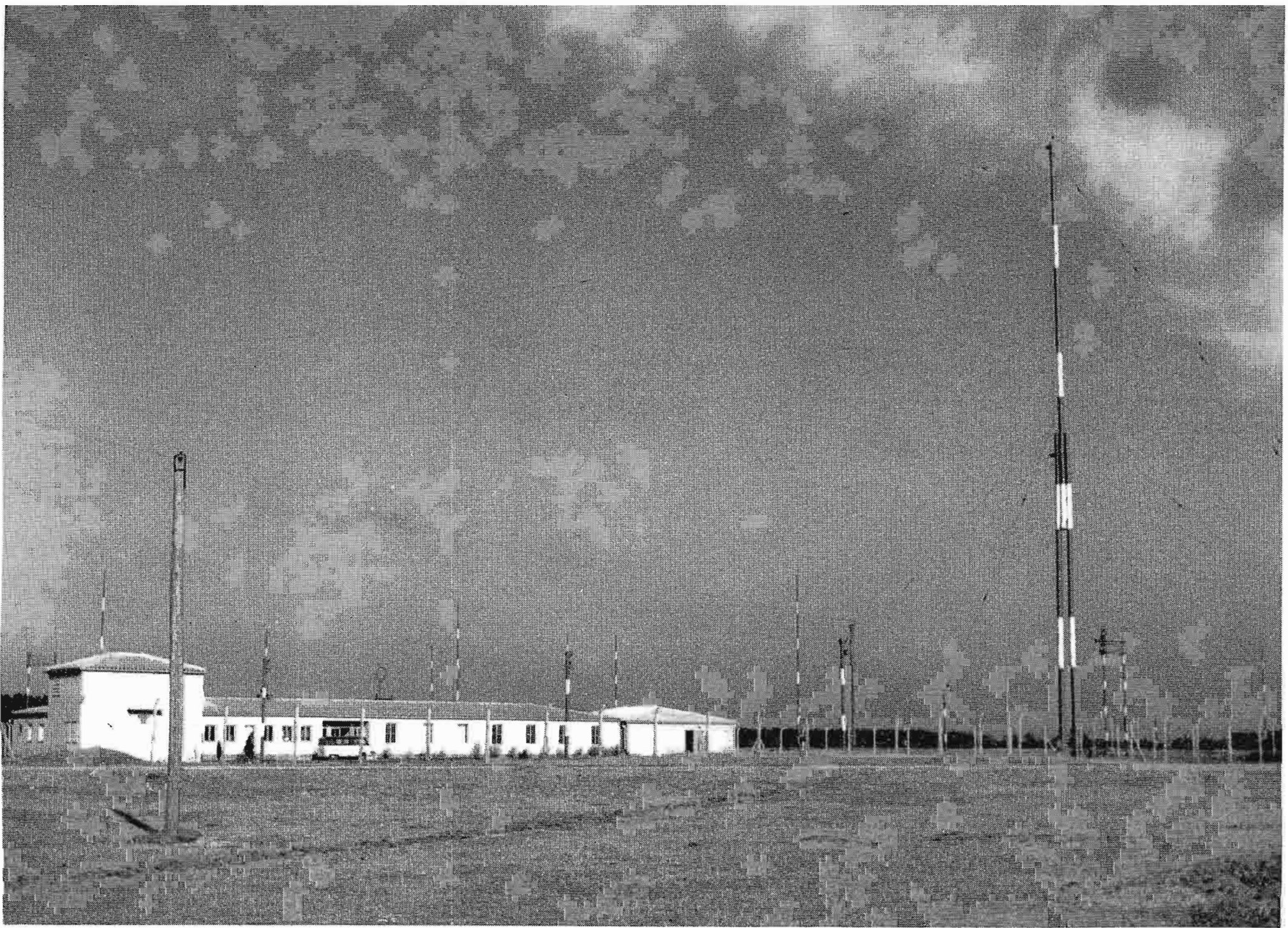
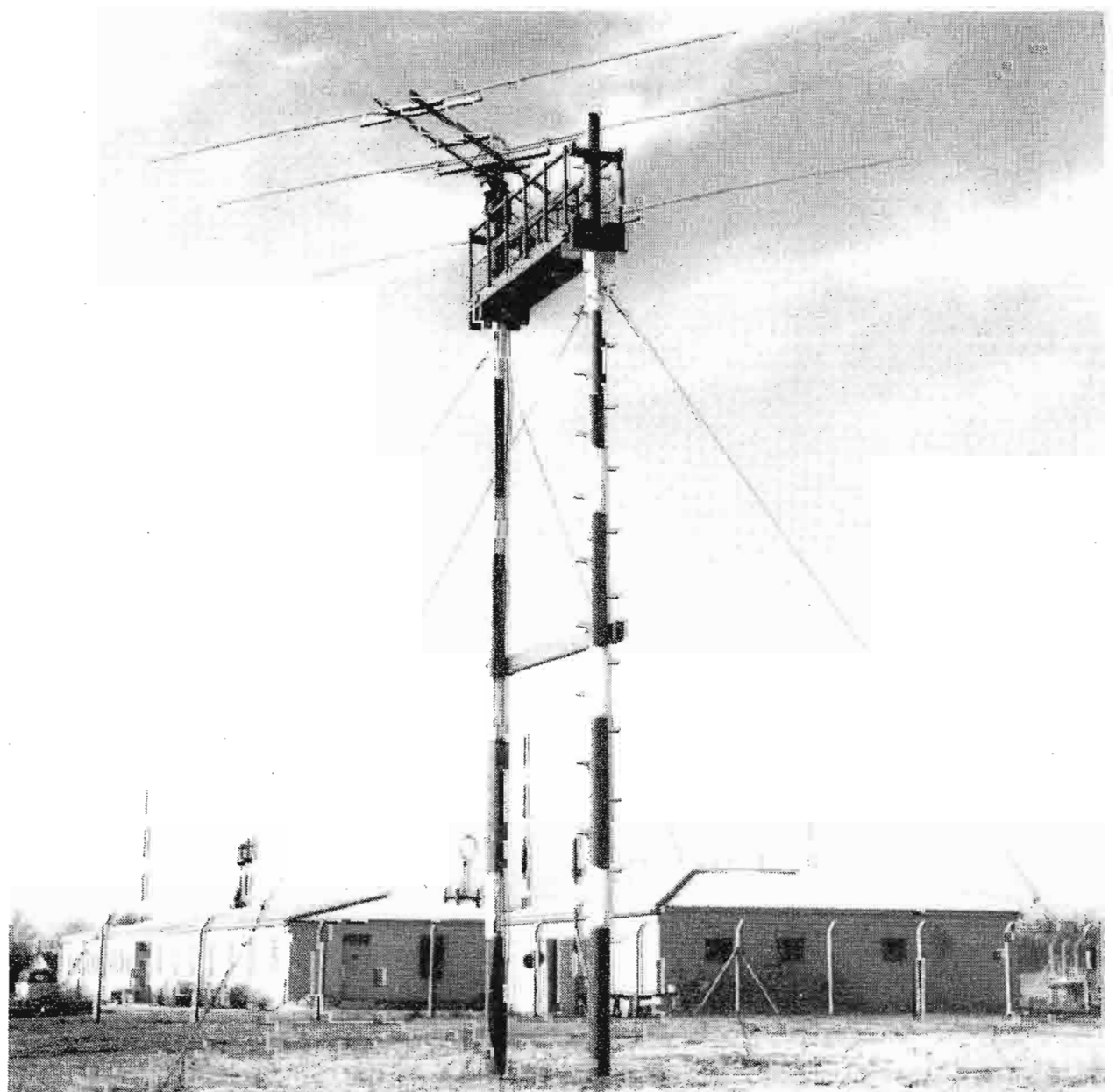

FIG. 18. Schleissheim monitoring station installation, seven miles from Munich. Signals are fed from here to Munich via telephone lines.

FIG. 19. Rotatable-beam antenna at Schleissheim is one of many types employed to extract signals of local Iron Curtain stations from the ether.



Schleissheim Monitoring Station

The Schleissheim monitoring station is the "ears" of RFE! From this installation comes the raw material from which RFE programs are produced. Receiving engineers and information department monitors turn their dials and from the ether pluck the signals of the Communist broadcasts, reconstructing on printed pages the output of the Communist press and radio.

First, they listen to and record the domestic version broadcast for home consumption from satellite stations like Radio Prague, Radio Budapest, Radio Sofia, or Radio Warsaw. Then, from satellite news agencies, they tune in on propaganda meant for Western ears. Lastly, to keep things on an even keel, up-to-the-minute news is received from the U. S. A.

The receiver station staff and the content monitors supply RFE newsmen and program staffs with all versions, and by comparison they discover the big lies of Communism and answer them with facts. Some of the material is delivered to the news and program departments in the form of typewritten copy prepared by content monitors from recorded satellite broadcasts. Much of the rest of it starts as Morse, Hellschreiber or teletype signals sorted and sifted out of the crowded ether, refined into usable form by radiomen and finally sent down the telephone lines from the Schleissheim to Munich to appear in printed form on teleprinters in the newsroom.

Interference Problems

Listening to Communist transmitters poses a big problem since many of the stations are low-powered, designed for local

broadcasting and are usually located several hundred miles away. Nearby principal terminals of Voice of America and the U. S. Armed Forces also pose selectivity and crosstalk problems. Loop antennas have been used with some success, but these are not so good at night because of sky-wave interference. Two-tower vertical directional arrays have been erected to cope with the problem. In addition, another site at Mooseburg, some 30 miles from Schleissheim, is used to get around interference problems.

Typical Monitor Booth

The equipment in a typical monitor booth consists of a communications receiver that can be tuned by the operator for his convenience. Also, a two-position switch is available to switch antennas. The operator is usually a trained journalist in a specific language. He has available a tape recorder and a typewriter equipped for typing his specific language. His output is turned over to the desk chief at Munich. Extracts in English of the main highlights are sent to American policy people in Munich for their guidance in the conferences wherein the political addresses are prepared.

Technical Operations

Fifty communications receivers are used for the listening post at Schleissheim. Programs are received from the New York desk of RFE via Press Wireless, using triple diversity receivers and rhombic antennas. These programs are all "voice." Teletype plays a big part in the monitoring operations and each year some 1500

miles of tape are used and some 75 million words are copied from the various news agencies.

Telephone lines are used to connect Schleissheim with Munich so that the master switching center can monitor all incoming and outgoing lines. The Munich center also has intercom with all language monitoring booths and remote receiving sites.

Personnel

Mr. F. Sherwood, who was Asst. Chief Engineer of WHEC, Rochester, N. Y., is in charge of engineering at Schleissheim, with 45 technical people. Under Mr. Harold Peters, who has charge of program monitoring at Schleissheim, are 22 monitoring people. In addition there are various other building workers and a security force.

Antenna Systems

Programs transmitted by commercial radio from New York City are received at Schleissheim on a triple-diversity system using standard communications receivers and rhombic antenna systems. For monitoring the stations in satellite countries numerous antennas are used, including long-wave, open-V, and Yagi with appropriate commercial receivers.

There are a number of rhombic antenna systems in use. One is headed towards Warsaw and Moscow, two towards the U. S. A. and a fourth towards Lisbon. Three others are reversible rhombics for coverage of either Istanbul or the U. S. A. In addition there are two Beverage antennas, a cross-loop and goniometer arrangement, and several inverted rhombics.

FIG. 20. Monitoring is by four methods: Direct-Voice, radio teletype, Hellschreiber, and Morse code. Here is an operator receiving Morse code and transcribing it on a teletype perforating machine.

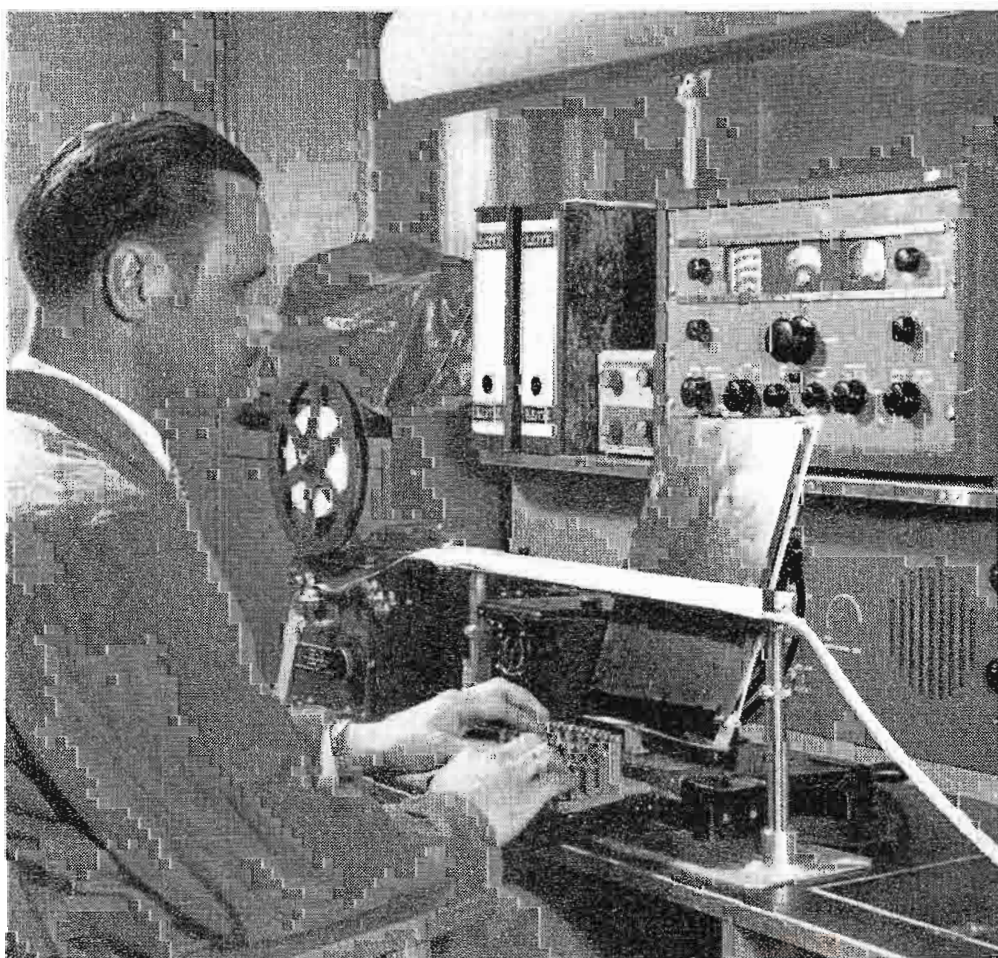

FIG. 21. Typical output of a Hellschreiber recorder. This is being fed from an RCA Communications receiver. The monitoring output at Schleissheim is fed to Munich via telephone lines.

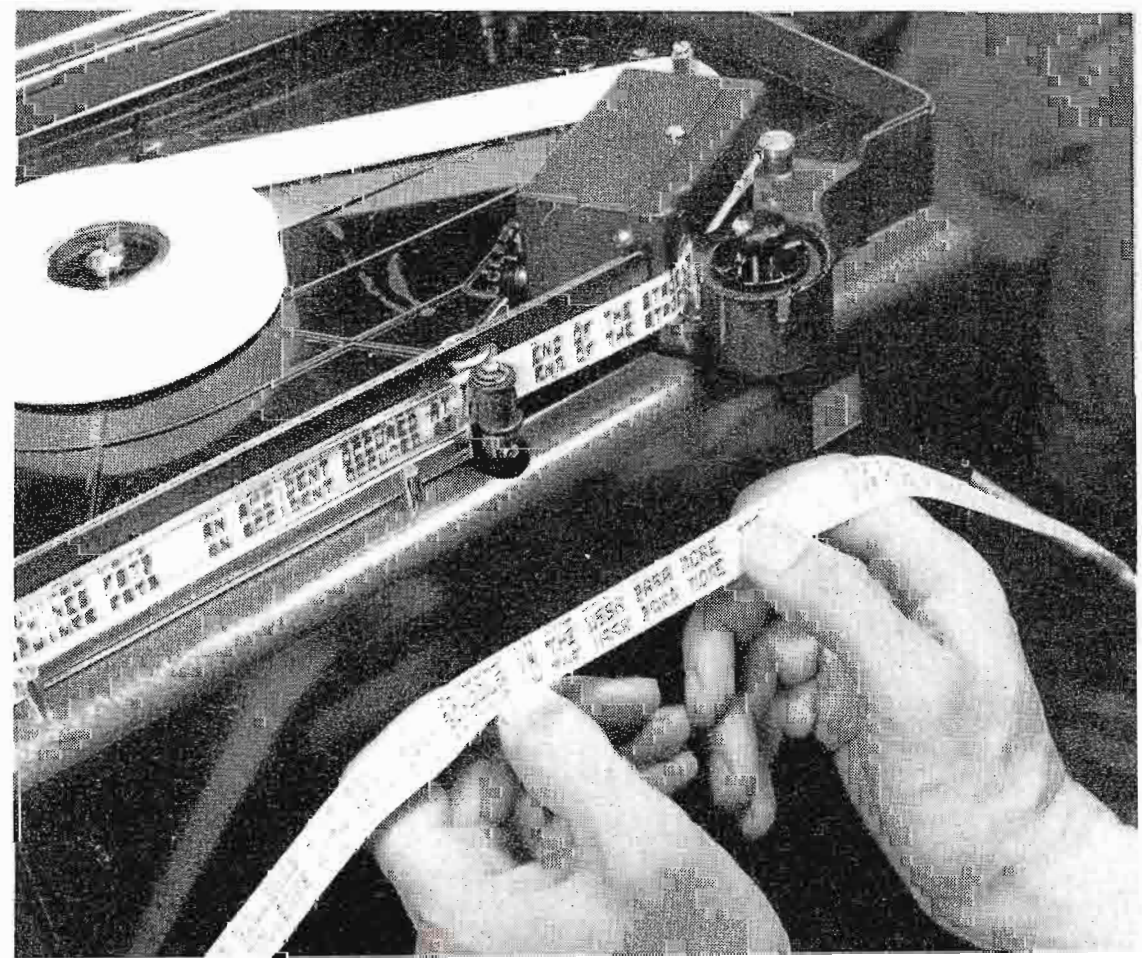



FIG. 22. RFE transmitting plant at Biblis, Germany, some 200 miles northwest of Munich. Eight transmitters are located here—the center of the RFE radio barrage projecting the voice of freedom to countries behind the Iron Curtain.

Biblis Transmitting Center

Near this small town, some 200 miles northwest of Munich and about 50 miles south of Frankfurt, lies an abandoned airstrip which is now the home of eight transmitters scattering messages of hope behind the Iron Curtain. There are four 10-kw, one 20-kw and three 50-kw transmitters, which operate on the international short-wave bands. The control room panel was designed and built by RFE engineers to accommodate five incoming lines, and additional miscellaneous inputs as needed, to the eight transmitters. Incoming lines carry program connections from the Munich studios, connect to the Deutsche Post, and also provide emergency connections to the studios. In addition, stand-by tape recorders are available in case of program failure to provide music for broadcasts in each of the languages. A 14-channel, tape recorder monitors all incoming lines, plus transmitter outputs and time signals, to keep a permanent record of all operations.

Central Oscillators

All crystal oscillators for the transmitters are installed in central racks for ease of frequency change and frequency control. These crystal units are not the ones originally supplied with the transmitters, be-

cause RFE engineers have found it more appropriate to employ one uniform type of their own design. These crystals are high stability units in thermostatically controlled ovens and are all ground to the same correlation factor. Included in the master bank are three variable frequency oscillators which are used temporarily whenever a new frequency is assigned (until new crystals are ground). An electronic counter is used for measuring and checking crystal frequency output.

Power Supply

Commercial power comes in at 20,000 volts and is brought down to 380 and 460 volts for operation of the transmitters and other equipment. Some 750-kw is required to operate the transmitters at Biblis. Commercial reliability is high so no emergency power unit is required. A small battery system is provided for emergency lighting should it ever become necessary.

Antenna Switching System

This is a 9-by-12 universal-type of crossbar system built by RFE engineers and works at 600 ohms. The design went through several small model changes and

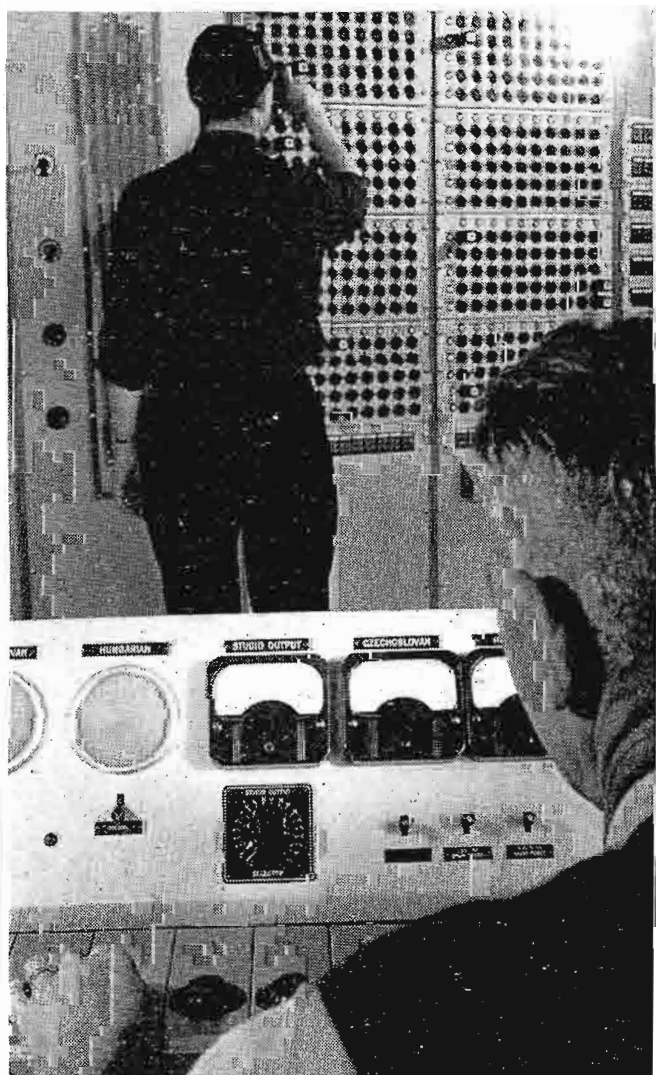

FIG. 23. Master control for feeding programs to Biblis transmitting plant. This control was designed and built by RFE engineers.

has been so stable and effective that it attracts wide interest throughout Europe. The same design is employed for the transmitters at Portugal. It is truly universal, connecting any of 9 transmitters to any of 12 antennas, and will handle 50-kw of power per switch.

Antenna Systems

Rhombic and curtain antennas are used. The curtain antennas consist of one, two or four elements with a tuned parasitic reflector associated with each element. High gain and control of directivity are characteristic. These are determined by choice of operating parameters and physical dimensions of radiating elements. Each individual element consists of a driven antenna operating as a dipole.

To achieve high performance of the curtain, the parasitic reflectors are adjusted for proper phase and magnitude of current in the reflecting element and the input tuned for proper impedance. Basically these antennas are broad-band systems, each being designed to cover two adjacent international broadcasting bands. Separate sets of tuning stub and switch arrangements make it possible to make the change-over quickly.

Experimental work has been going on with diplexers—working two transmitters on different frequencies into the same antenna. This work or experimentation as related to RFE's requirements has been proved in the lab at Munich under direction of Mr. Perry Esten using scaled model antennas on UHF frequencies. Actual testing in the field proved the theory and the diplexer has been placed into operation with satisfactory results.

Personnel at Biblis

There are some 50 persons employed in the transmitting plant at Biblis under the direction of Mr. Fred Parry. Of these 16 are actually engaged in transmitter operations and maintenance. The remainder are drivers, cooks, accountants, draftsmen, machinists, clerical, etc. There are three 8-hour shifts daily—working round-the-clock 7 days a week—since the transmitters are always in broadcast operation or for maintenance.

* * *

EDITOR'S NOTE: *Part II, the concluding part of this article, will appear in our next issue, and will be devoted to RFE Installations in Portugal.*

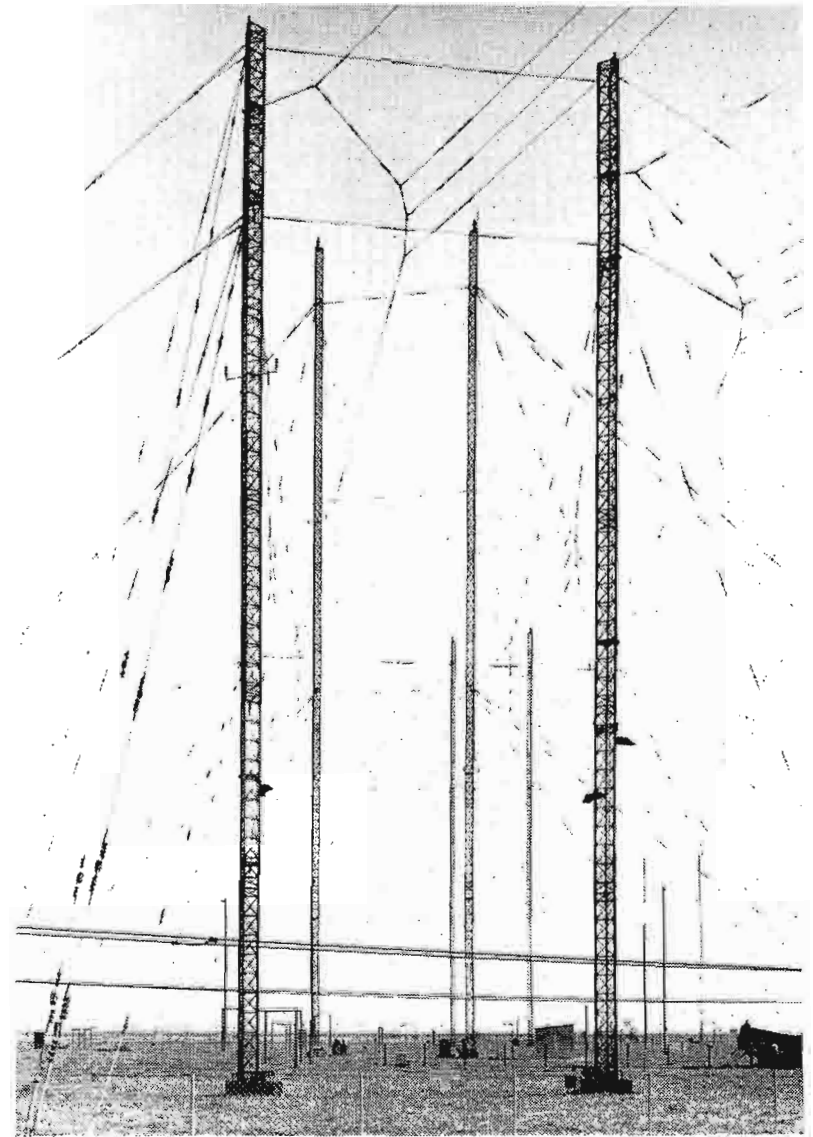

FIG. 24. Typical curtain antenna system used at Biblis transmitting center.

FIG. 25. Antenna switching system at Biblis employing 9-by-13 crossbar built and designed by RFE engineers.

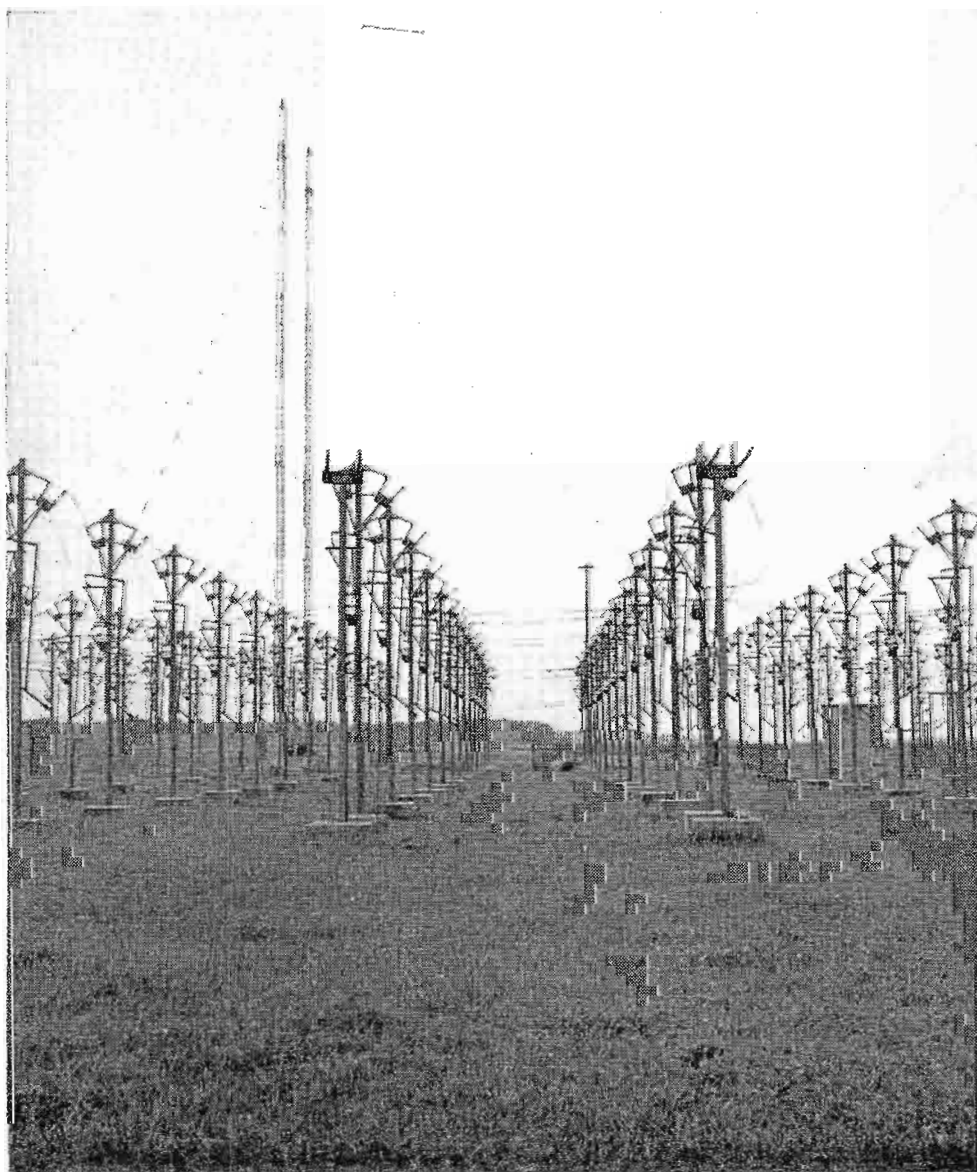
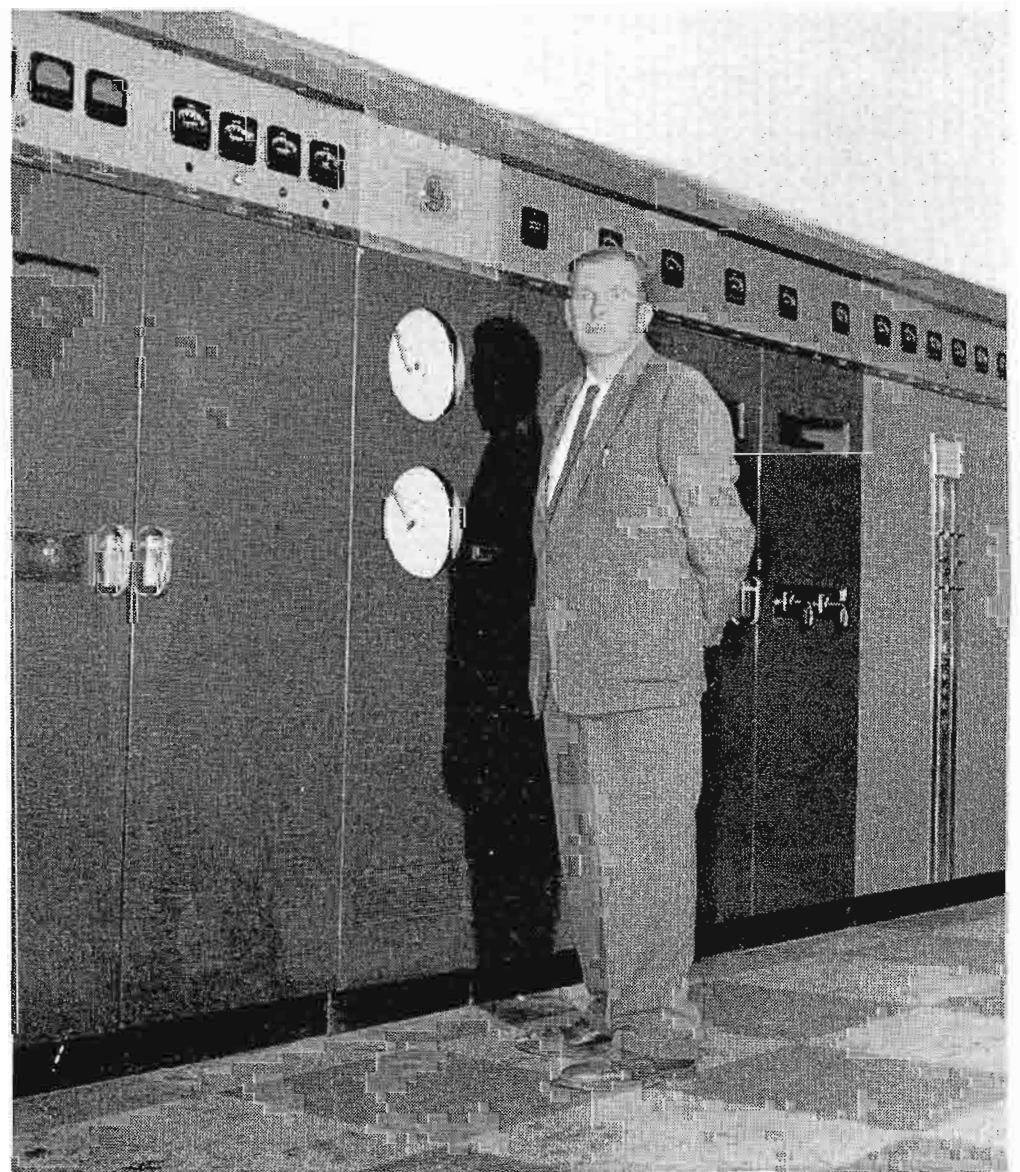

FIG. 26. Fred Parry, engineer in charge, shown at 50-kw RCA transmitter in Biblis, Germany; transmitting plant of RFE.





MEMPHIS' NEWEST RADIO STATION

In October of last year, radio station WHER successfully completed its first year of operation—which indicates that Memphis area listeners like what they hear from this latest addition to the broadcasting fraternity. Station WHER is a one-kilowatt daytime operation, broadcasting on a frequency of 1430 kc, with well-equipped studios located in a large modernistic motel close to the heart of downtown Memphis.

Although the novelty of an all-girl station was enough to tempt many people to turn to 1430 on the dial, only a good solid programming format has kept them there. The combination of effective programming and excellent technical facilities has resulted in an outstanding new radio station in Memphis.

Programming

Since the programs are “keyed to women”, Sam Phillips, General Manager and part owner of the station, felt that a woman could convey to other women, household hints, etc., better than a man—hence an all-girl station. Active direction of the station’s operations is handled by Dotty Abbott, Assistant Manager and Program Director. She also opens the day accenting bright music from six to nine a.m., and closes it with jazz and slow music from four until sunset. The station features easy to listen to popular music (strong on instrumentals) with some jazz for contrast. WHER has yet to play a rock ‘n’ roll or hillbilly record, which seems paradoxical since Mr. Phillips is the owner of the Memphis Recording Co., the Sun Record label and a developer of the new rock ‘n’ roll music.

News is given at four minutes before every hour and much emphasis is placed on local news events. Local happenings are covered not only in newscasts, but on special broadcasts as well.

Like any new station, WHER was slow in getting sponsors. As you might expect

with an all-feminine staff, beauty parlors, dress shops and cosmetic firms were quick to advertise. However, the station did not waste any time proving that it could also sell automobiles and real estate. They have produced results for such unusual sponsors as an auto body repair shop and a company selling motor parts.

Local interviews are very important to WHER and as yet no public service announcement has ever been turned down. All interviews are brief but comprehensive—informal yet to the point. Musical backgrounds are often used on recorded spots and WHER’s singing jingles (produced and recorded by the staff) are much in demand, not only on all of the stations in Memphis but in other cities as well.

One interesting fact about WHER’s move into the crowded Memphis market is that the station has succeeded in developing *new accounts* for radio. At this time WHER is 80 per cent commercial.

The Staff

The girls here run their own control boards, select their own music and record transmitter readings. They write, produce and record all of their own commercials and use a simple selling technique on the air. Spots are cut on 45 rpm records—not on tape, the feeling being that records are easier to handle. No affectation or know-it-all attitude is employed—there is no such thing as a “woman announcer” approach to announcing. The management of WHER feels that their announcers can be effective on-air “salesmen” if they talk to their audience in the same voice and with the same enthusiasm and sincerity that they would use over the back fence.

Six of the girls have their own program with emphasis on some particular subject of interest to housewives. Only the two “saleswomen” don’t go on the air. Each girl selects her own records from the ever-growing record library. The accent is on variety with no jarring changes from one

selection to another. A smooth continuity of programming is strived for with a minimum of DJ chatter. Not over two records are ever played without some commentary in the selections. The commentary never takes the form of adverse music criticism of a selection.

One of the biggest on-the-air problems are the baseball scores. There is something terrifying about them for some mysterious reason. Although the girls understand the UP code, and know by consulting a chart which team is in which league—they can't seem to make the scores sound believable. It is possible that the winning and losing teams may be announced, but the thought that a winning pitcher might be named, or that the number of hits and errors would also be given is completely beyond the realm of possibility. One of the girls summed it up perfectly while conducting an afternoon disc jockey show. "Well," she said to her startled listeners, "I feel real reckless today. I think I'll read some baseball scores."

The station is decorated in a very disconcerting, albeit attractive, feminine manner. As the visitor enters the lobby, he is confronted with a white, tufted leather, reception desk partially encircled by green plants. The mingling scent of perfumes greets you as you walk in the door. Every door has some unusual name on it such as: "doll dell" for the studio; "playroom A and B" on the control rooms; "girl friday" on Miss Abbott's door.

Studio/Control Rooms

WHER has fairly elaborate equipment facilities—boasting two complete control rooms. Each control room is equipped with a BC-2B Audio Console, two 77-DX Polydirectional Microphones, two BQ-2A Turntables and a wall speaker housing for a LC-1A Speaker Mechanism. The audio consolettes are hooked up through a relay arrangement to permit turning over program control from one control room to the other. Since the BC-2B on the air has "priority," switching is done from the "on-air" audio consolette. Each consolette at



FIG. 1. Dotty Abbott, Assistant Manager and Program Director of WHER, also has her own morning and afternoon shows.



FIG. 2. Continuity Director at WHER is Dot Fisher shown here at the BC-2B Audio Console in Control Room A.



FIG. 3. Complete equipment facilities in Control Room A include a BC-2B Consolette, two BQ-2A Turntables and two equipment racks.

WHER handles the two BQ-2A Turntable inputs, four microphone inputs, a tape input and a remote input. The station has two BN-2A Remote Amplifiers which are available for use on remote pickups.

The music studio, just opposite Control Room A, has two microphones which are tied into the BC-2B Consolette in each control room. The input transformers of both of the audio consolette are connected in series. Masonite perforated tile walls, acoustic tile ceilings and rubber tile floors in the studio and both control rooms provide good sound absorption and freedom from resonances.

Control Room A, measuring approximately 10 by 10 ft, is shown in Fig. 2, and Control Room B (6 by 8 ft) can be seen in Fig. 5. Note the standard music rack which is mounted on top of the consolette. This provides a convenient support

for script material, thus removing the inevitable clutter of papers which would otherwise result. The circular object on the wall above the turntables in Control Room A is a large red light which goes on when a Conelrad alert is called. Station WMC is the key Conelrad station in Memphis.

Two equipment racks complete the technical facilities in Control Room A. One rack contains the equipment for remote control of the transmitter. The rack equipment consists of a remote metering and control unit, a percentage modulation meter and a VU meter. A receiver for off-air pickup monitoring and a patch panel are also included in this rack. The other rack contains the Conelrad alert receiver, tape input selector switches and power supplies. The sound engineering planning and compact arrangement of facilities at WHER have thus resulted in an installation where operating ease has reached an optimum.

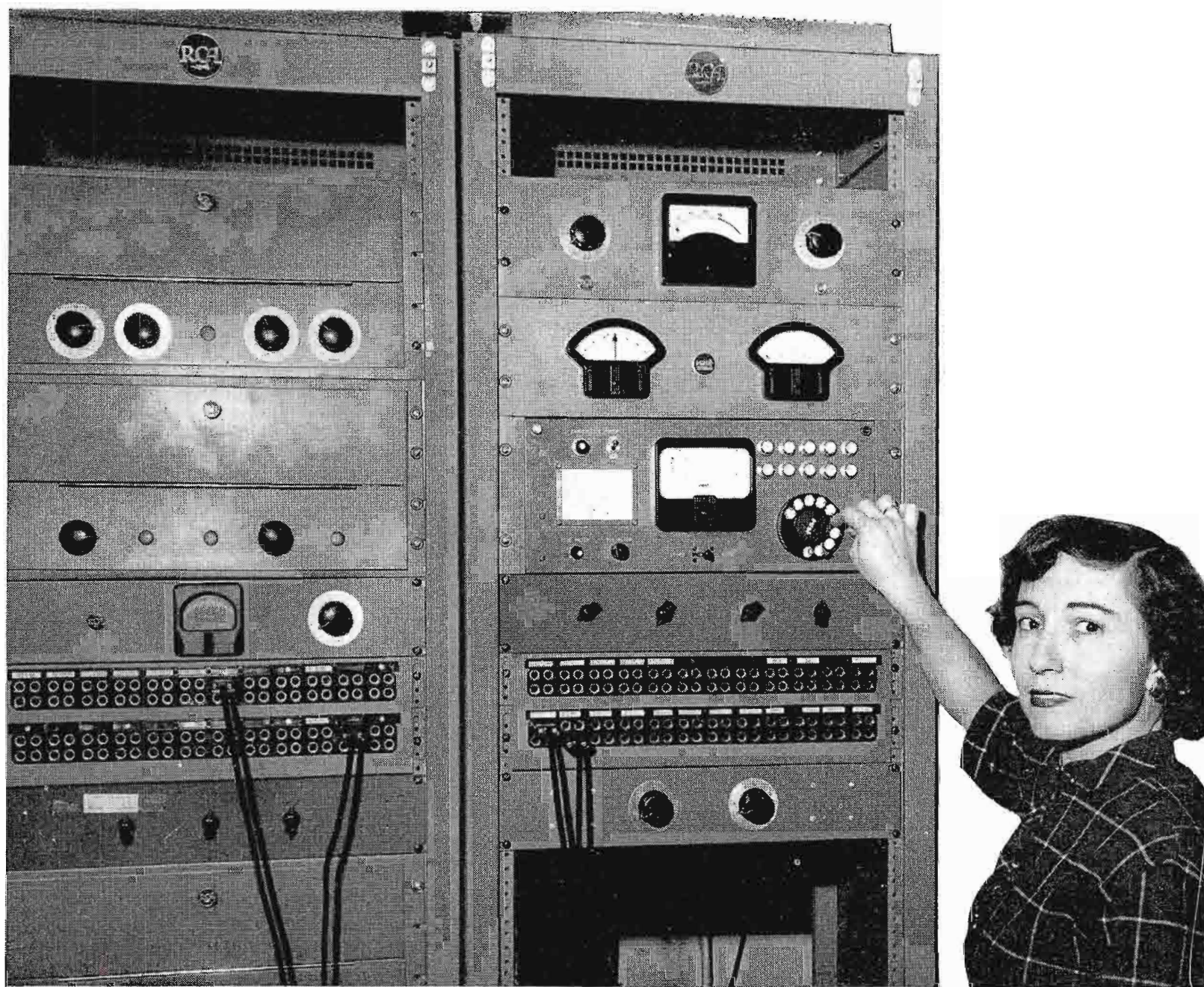
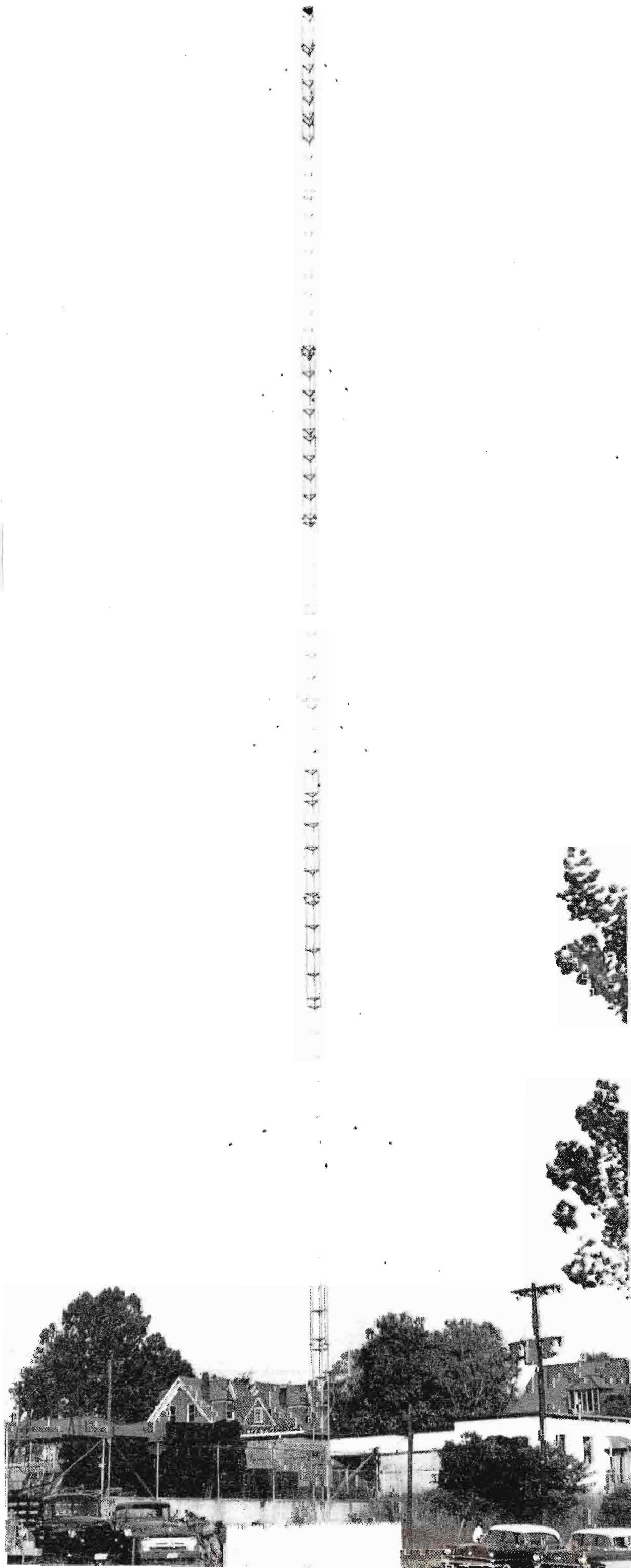

FIG. 4. Transmitter readings are checked by Becky Phillips on the remote system control unit in Control Room A.

FIG. 5. Control Room B is located right next to Control Room A and also contains a BC-2B Console and two turntables.

FIG. 6. Kathy Hartley, at the piano in WHER's studio, also has her own DJ show.





Transmitter Site

The 1-kw AM remotely controlled BTA-1M Transmitter is located in a much more conventional setting—a small brick building in northeast Memphis (see Fig. 8) about three miles from the studios. A rack in the transmitter building holds the remote control switching unit and all the metering facilities necessary to check transmitter performance. These include carrier level and percentage modulation meters as well as indication of decibels of gain reduction and cycles of frequency deviation. Figure 9 shows W. D. Cousar of the Memphis Recording Co., who maintains all the equipment at the transmitter and studios.

The nondirectional, series-excited $\frac{1}{4}$ -wave antenna is of uniform cross-section. Each of the three guy anchors support the 173-ft Stainless tower at four points. A ground system of 120 radials (No. 10 wire) of 150-ft long, buried copper wire is used in conjunction with a 48 by 48 ft copper ground screen. A BPA-11A/B Antenna Tuning Unit at the tower base houses the antenna-tuning and line terminating components for matching the antenna to the coaxial transmission line.

Remote Control System

The control unit for the remote system is located in one of the equipment racks in Control Room A at the studios, while the switching unit is situated at the transmitter installation. Basically, it is a dc system using a standard dial telephone principle. Two circuits, consisting of telephone pairs, are employed from the control unit to the switching unit. One circuit is a metering circuit for checking readings of filament line voltage, final stage plate voltage and current as well as antenna current. The other circuit is used for control purposes for final stage tuning, output power control and turning filament and plate power on and off.

Conclusion

From smooth running technical facilities to good solid programming, the success story being written at *WHER* has been watched with considerable interest. To quote Dotty Abbott, "We are not trying to prove that we can get along in a world without men. We are simply trying to prove that when a group of women make up their collective minds that they are going to do something successfully, no force on earth can keep them from it." The story of *WHER* in the crowded Memphis market seems to bear her out.

FIG. 7. A 173-ft tower serves as *WHER*'s non-directional, series-excited $\frac{1}{4}$ wave antenna.

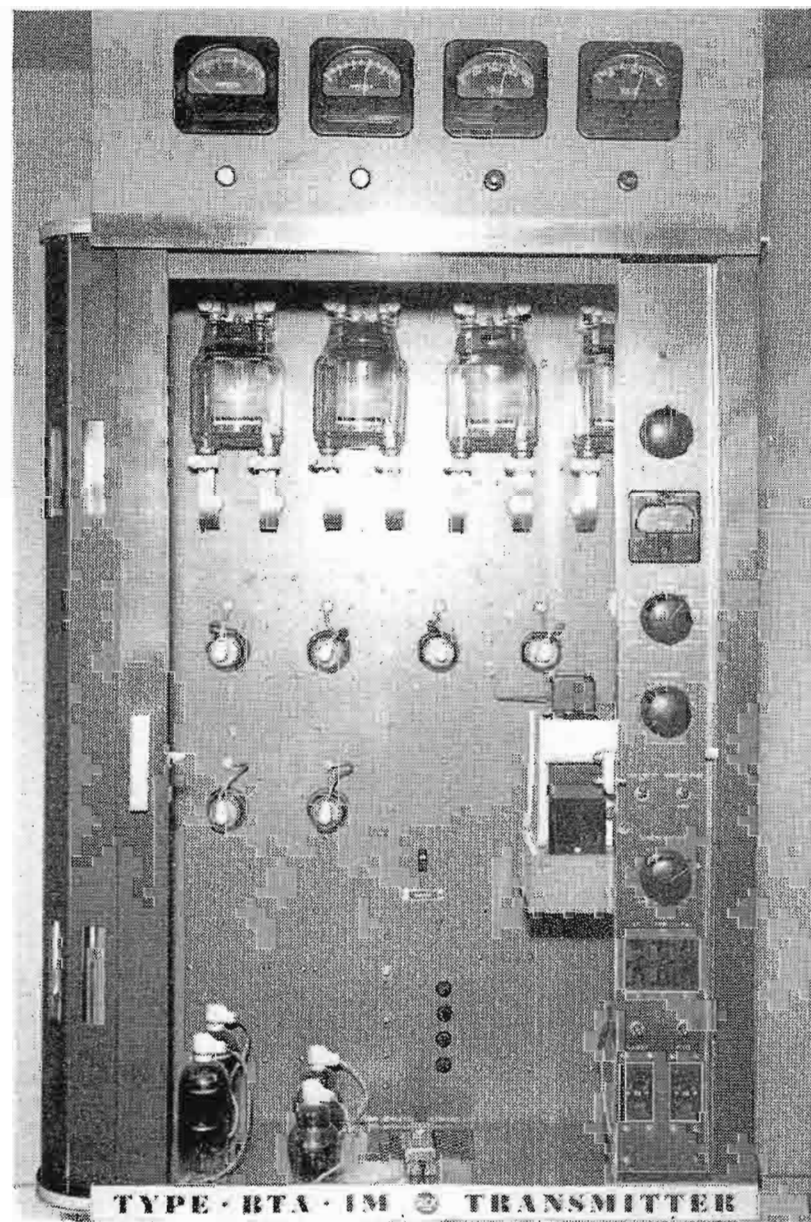

FIG. 8. Transmitter building contains a remotely controlled RCA B1A-1M AM Transmitter.

FIG. 9. W. D. Cousar, who maintains all equipment at WHER, checks readings at switching unit of remote control system in transmitter building.



FIG. 10. Maximum output is 1100 watts to compensate for transmission line and antenna tuning equipment losses.



KSTP INSTALLS RCA 50-KW AM AMPLIPHASE TRANSMITTER

by A. W. POWER,
Broadcast and Television Sales

The complete installation of RCA's new Type BTA-50G AM Broadcast Transmitter at KSTP in St. Paul, Minnesota, was accomplished in just three weeks under the supervision of Bill Sadler, Chief Engineer. This installation was done at a cost of only \$4200.00 and included the building of a complete wall and doorway for the high-voltage plate transformer vault, the pouring of a concrete floor for this vault, as well as the physical and electrical installation of the wall-mounted switchgear and the actual installation of the transmitter itself.

It can be seen from the photos on these pages that the Ampliphase 50-KW Transmitter has been specifically designed to fit into the existing floor space of most 50-kw installations. The small size of the BTA-50G permits transmitter replacement without loss of air-time. At today's building costs, the savings in installation are obvious to the broadcaster contemplating the acquisition of a new 50-kw AM transmitter. Additional savings at KSTP are being realized in reduced power bills. The power consumption of the old composite 50-kw transmitter was about 265 kw—the RCA BTA-50G will average approximately 100 kw.

Further savings will be realized by the use of the 5671 power amplifier tubes. All of the stations using this tube report "fantastic" tube life—KDKA in Pittsburgh reports 65,000 hours of 5671 tube life and is still going strong. It is conservatively estimated that tube life in the order of 30,000 hours will be realized in the BTA-50G.

In the light of possible favorable action on the proposed remote control of higher power AM transmitters—all of the control circuits in the new BTA-50G were air-checked, and were found to give excellent performance. As supplied, the transmitter has one manual switch to change the control ladder to remote operation. In addition to the equipment necessary to monitor such functions as modulation, frequency, tower lights and the actual studio and control functions themselves—it is planned to offer a remotely controlled Delta-Wye switch as an optional item.

According to Bill Sadler, plans call for use of the old composite 50-kw transmitter as a stand-by unit. The entire transmitter installation at KSTP is a prime example of the sound engineering and excellent planning which have gone into making this one of the nation's finest broadcast stations.

FIG. 1. Interior of transmitter building at KSTP looking toward the rear of the octagonally shaped room. At the far right, the four cubicles of the BTA-50G 50 KW AM Transmitter can be seen. Just to the left of the BTA-50G is a composite 1-kw stand-by transmitter housed in two cabinets. The control room at the center of the main transmitter room contains the transmitter test and measuring equipment as well as facilities for programming of records and station breaks. At the left of the control room, a portion of the old composite 50-kw AM transmitter can be seen. This composite 50-kw unit takes up approximately one-half of the wall space of the transmitter room. In contrast to this, the new BTA-50G occupies less than 15 feet of wall space—an area formerly occupied by a 10-kw FM transmitter.

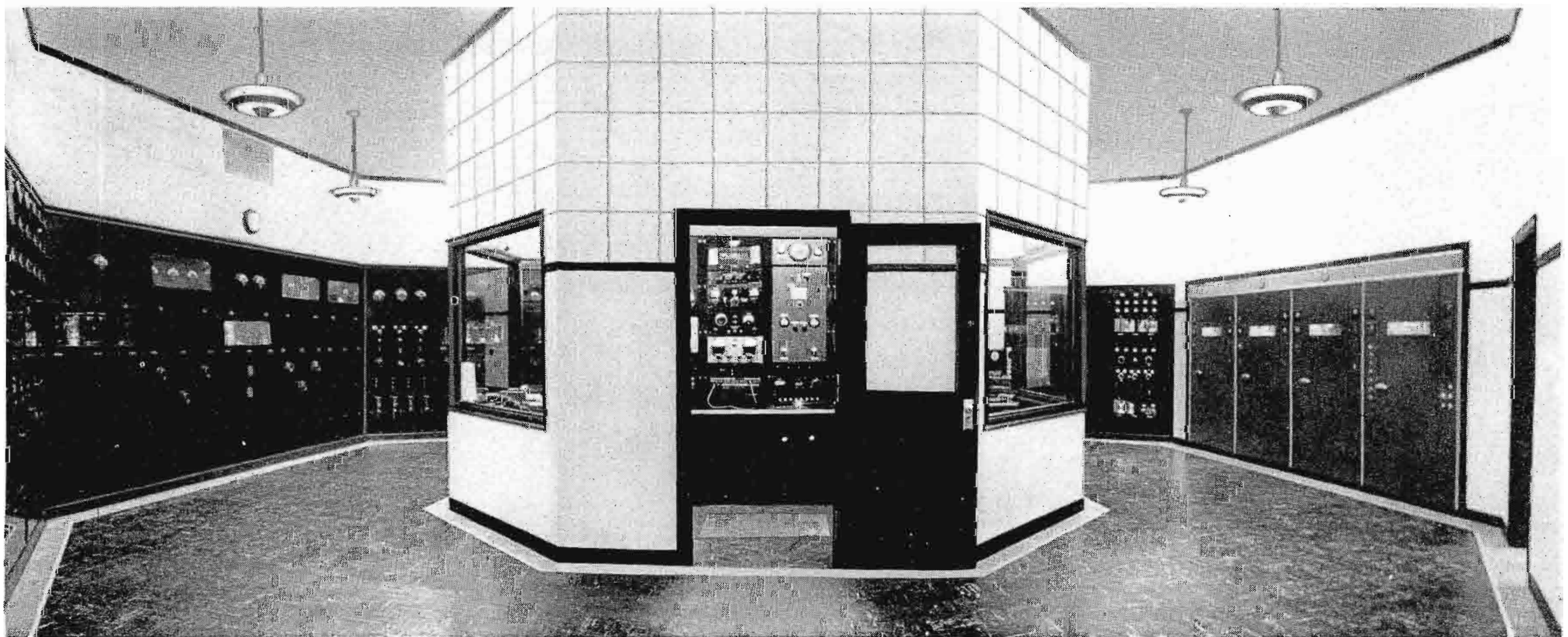

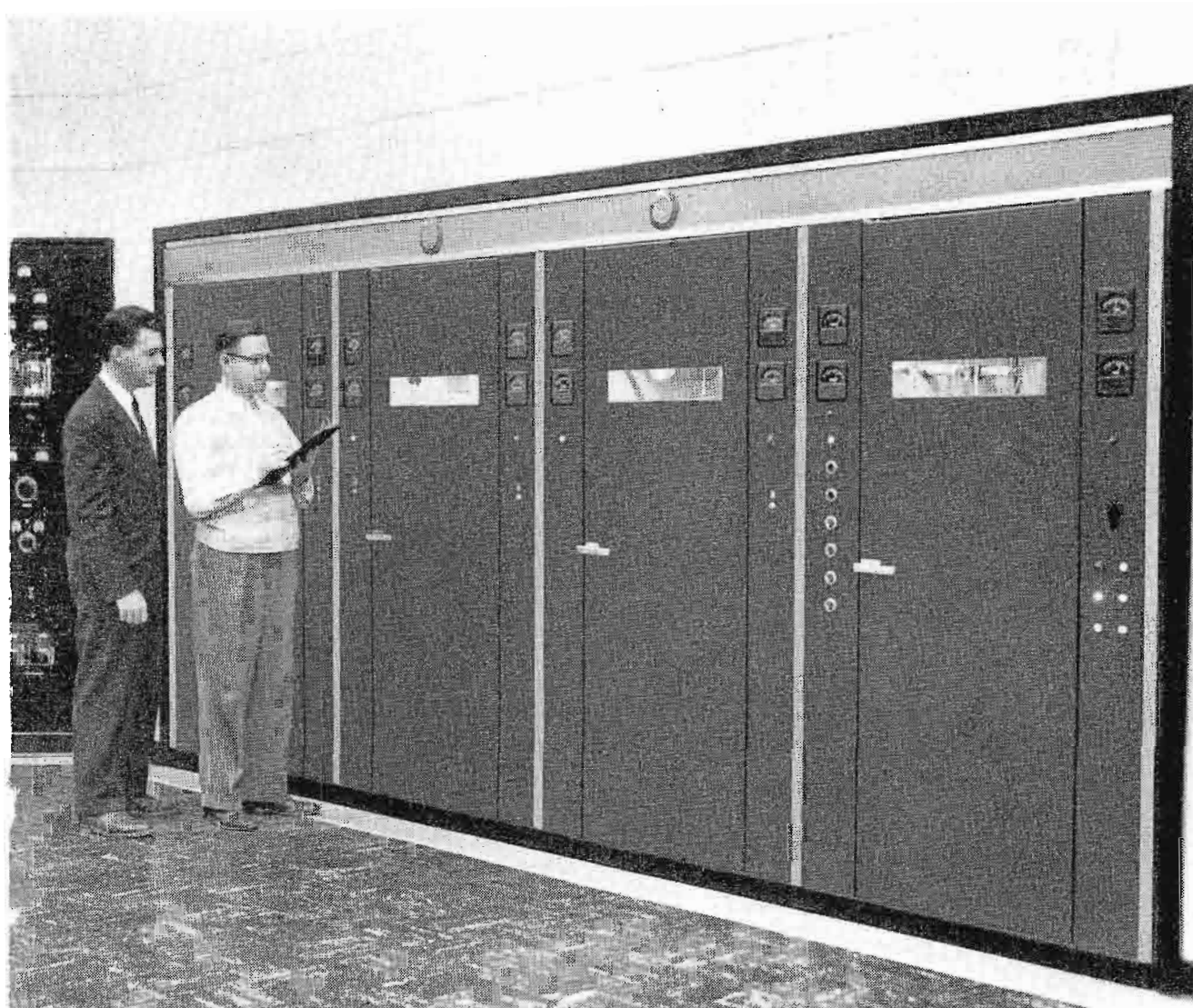

FIG. 2. William Sadler, Chief Engineer, and Howard Carlson, Transmitter Supervisor check performance of the new BTA-50G Transmitter showing from left to right: a final power amplifier stage, the exciter, a final power amplifier stage, and the rectifier cabinet.

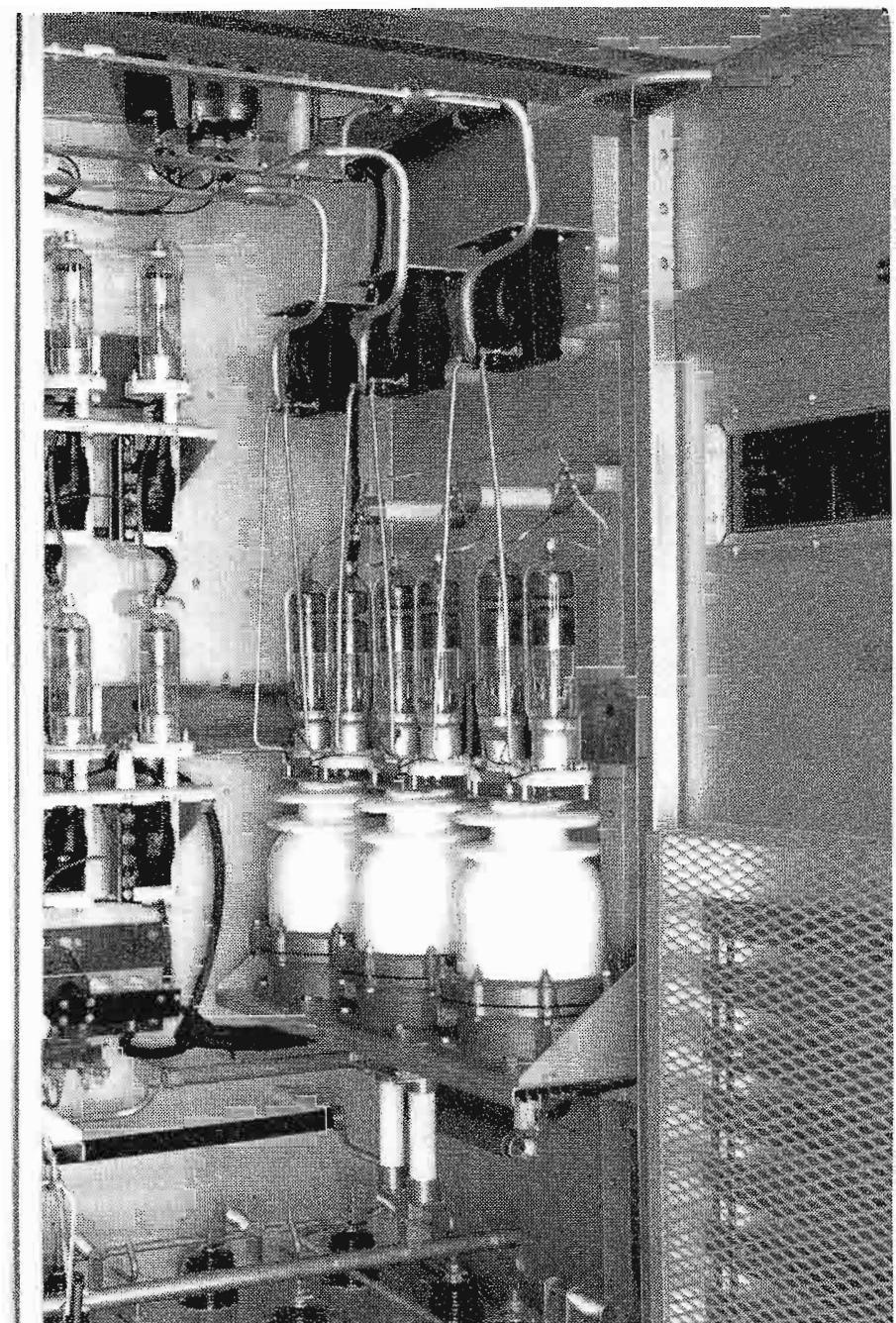

FIG. 3. Rectifier cabinet, front view, showing high voltage rectifier filament transformers and the low voltage 8008 supply. To facilitate remote control, the rectifier cabinet is air conditioned. The unit mounted on the front door is a thermostatically controlled heater. This heater, in conjunction with an exhaust fan, keeps the internal temperature of the cabinet within the operating limits of the mercury vapor rectifier tubes when the transmitter is in operation.

FIG. 4. Rear view of BTA-50G shows transmitter during installation. Bottom sections of frame are removable to allow heavy components such as the filter reactor, blowers and low voltage plate transformers to be moved into place.

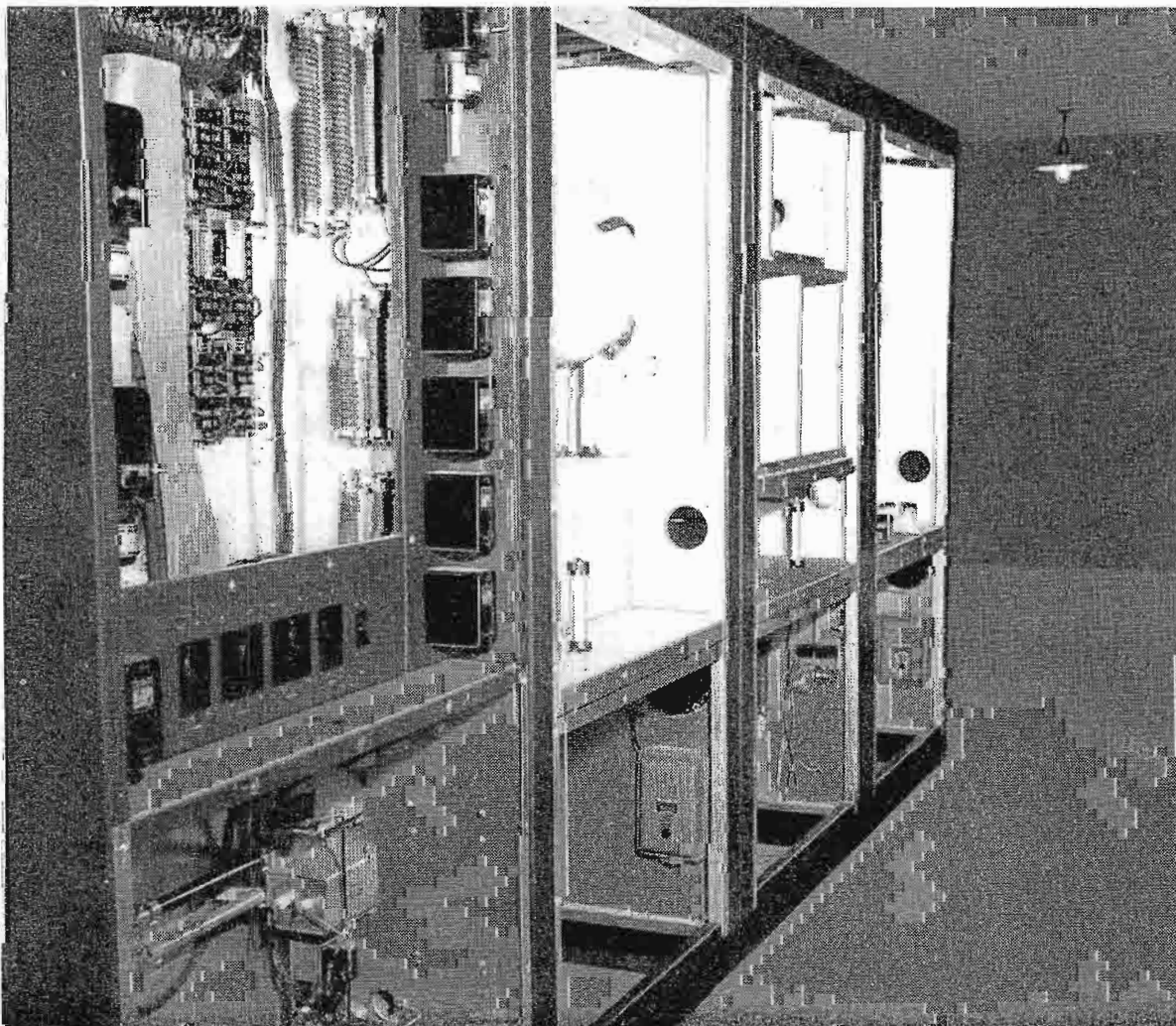

FIG. 5. Inspecting the right hand PA cabinet is William Sadler, KSTP's Chief Engineer. Note the generous over-size plate tuning capacitor. Vacuum capacitors are used in all stages to guarantee maximum dependability.





FIG. 6. KSTP chose to modify the typical arrangement of the wall-mounted switch gear—frankly, we feel that they have improved the arrangement. In the typical layout, the distribution transformers are mounted at the upper right at eye level—KSTP has installed all heavy components at floor level which eliminates the necessity for reinforcing the tile wall. Starting at the upper left, the top of the main line 400 amp/600 volt disconnect switch can be seen. This is the only piece of switch gear which must be supplied by the customer. Next in line is the plate breaker, a Delta-Wye switch, and the low-power, intermediate and distribution breakers. The two units to the right are the contact making voltmeters for the two voltage regulators at floor level. The three transformers to the left are the 460/230 volt distribution transformers which supply regulated voltage to the filament control circuits. The door to the rear gives access to the transformer vault and is interlocked for personnel protection. The clear layout is typical of the sound engineering practices used at KSTP.

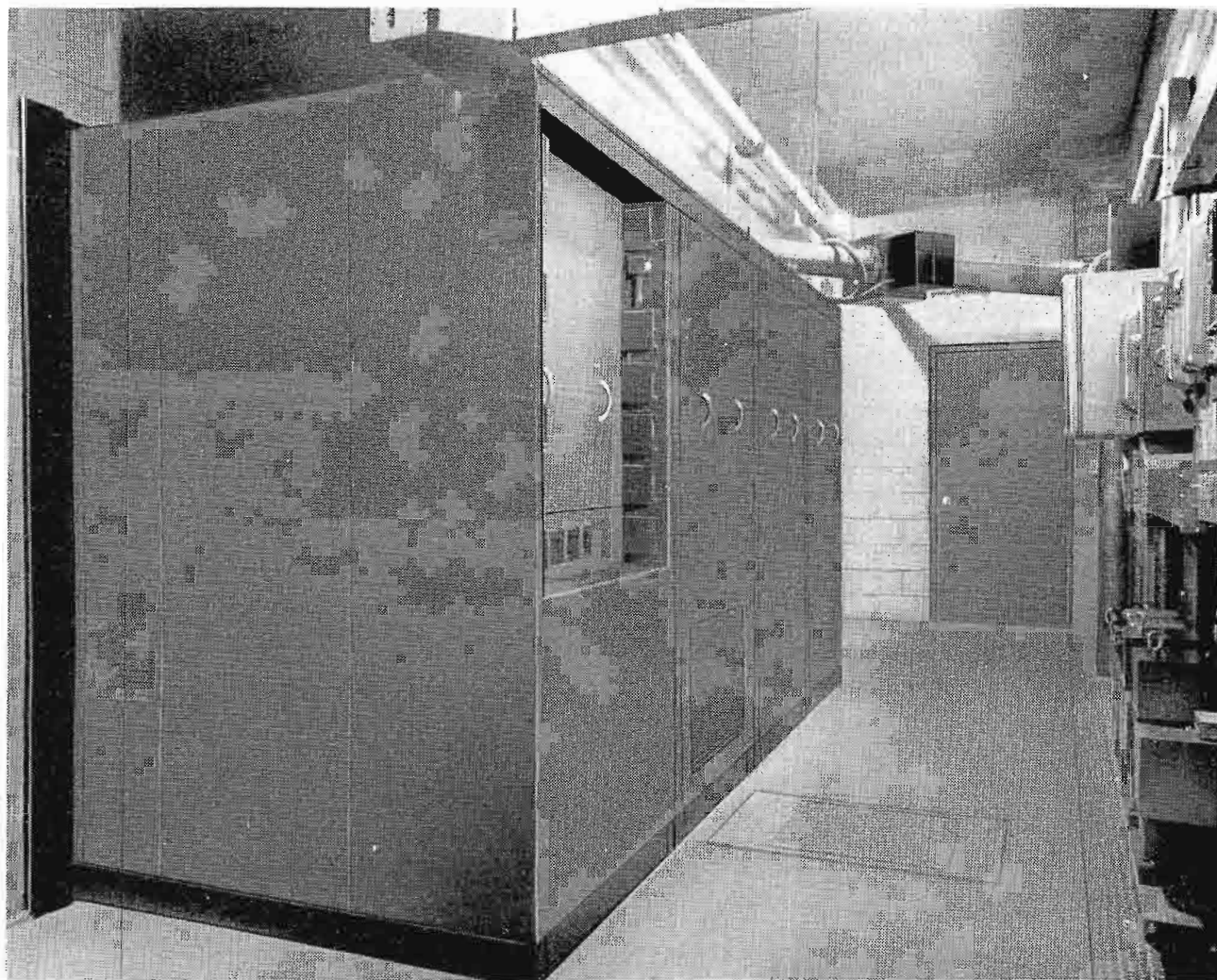

FIG. 7. Photo illustrates the complete shielding used in the BTA-50G to obtain the 83 db of harmonic attenuation for which the transmitter was designed. An interesting feature is the antenna protective device inserted in the transmission line (upper right)—this device operates on the reflectometer principle. A change in SWVR will develop voltages across a bridge circuit which will interrupt the r-f excitation—removing the carrier and preventing destructive arcs. The wall-mounted switch gear is shown at the far right. Two separate blowers in the bottom of the PA cabinets eliminates the need for air intake ductwork.

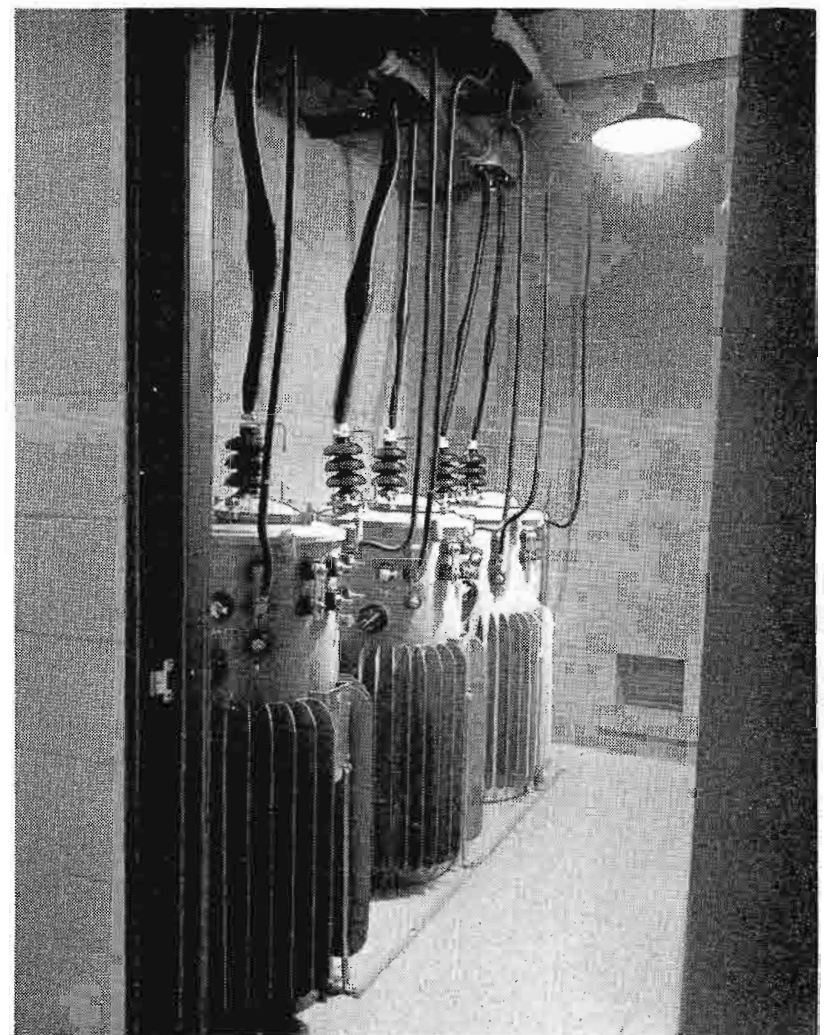
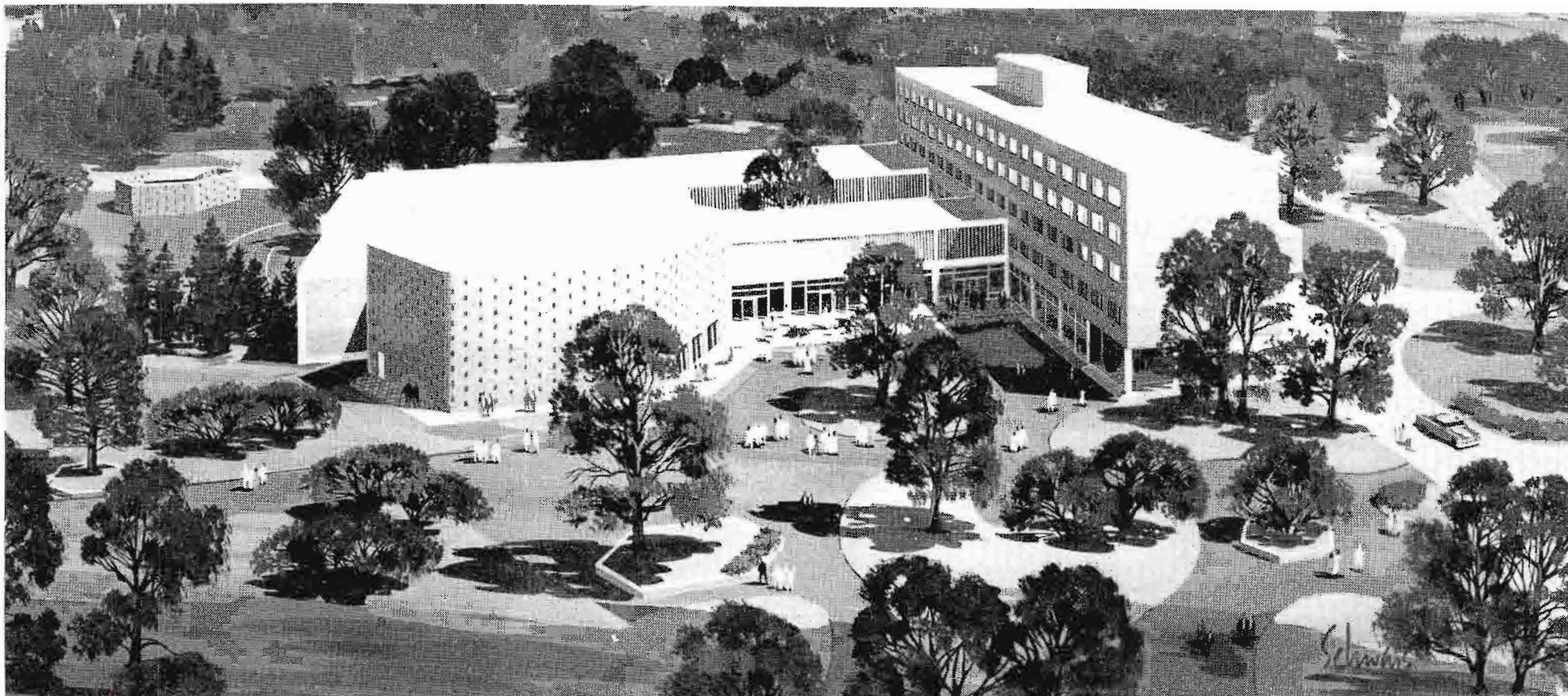

FIG. 8. Although the high-voltage plate transformers are weatherproof and can be mounted outside the building—KSTP chose to install them in a transformer vault. These are the only external transformers which require additional floor space. Note the individual temperature indicators on the transformers.

180
32
/



Architect's interpretation of the Georgia Center for Continuing Education which will open early this fall on the University of Georgia campus in Athens. The fully air-conditioned building will contain conference and seminar rooms, a 450 seat hexagonal auditorium, professionally equipped radio, television and motion picture studios, a library, lounge and exhibit areas. Its five story hotel-restaurant wing will house 300 students. Closed circuit radio and television programs related to current conferences will be piped into every room. *Photo courtesy of Stevens & Wilkinson, architects*

UNIVERSITY OF GEORGIA TO INSTALL EDUCATIONAL TV STATION AND CLOSED-CIRCUIT NETWORK FOR NEW EDUCATION CENTER

One of the nation's largest educational television systems will be furnished by RCA for the University of Georgia's new Center for Continuing Education, now in final construction stages on the Athens, Georgia, campus. Equipment for the Georgia Center includes a complete television broadcast studio; an off-campus 25-kw broadcast transmitting plant; live and film camera system for studio origination of program material; and 167 RCA Victor television receivers for closed-circuit presentation of studio programs in various study and discussion rooms.

Dr. Hugh Masters, Director, announced that the \$2,500,000 Center will function as a hub of adult education for the entire southeastern United States, as well as for the State of Georgia. The Georgia Center is supported by grants from the State of Georgia and the W. K. Kellogg Foundation of Battle Creek, Michigan.

"The installation of the RCA broadcast and closed-circuit television system," Dr. Masters said, "reflects the Center's planned objective to utilize the most modern means of communication as educational instruments to help adults solve problems encountered in daily living. Television's immediacy, flexibility, and dramatic impact are particularly essential to the Center's effectiveness since our educational programs will not adhere to established curriculum.

"The Georgia Center for Continuing Education will mark a departure from the

traditional school. Our courses of study will include any subjects for which there is a need and sufficient interest. We visualize a flexible program of conferences, seminars, and special courses, arranged as needed, to introduce latest experiences and educational information relating to virtually any broad problem—professional, business, industrial, cultural, social. The meetings will vary in length from a day to a month.

"A policy embracing such flexibility and extemporaneous planning also requires some cohesive medium which will enable the center to gather and present worldwide knowledge and experiences quickly and dramatically. Our studies convince us that television is that medium, and the Center was planned with broadcast and closed-circuit television in mind as educational instruments."

The Georgia Center for Continuing Education is incorporated in a single functional structure which integrates complete educational and living facilities. Educational facilities are housed in a two-story academic section which eliminates traditional classrooms in favor of academic suites and conference and seminar rooms. Features of the academic section are a 450-seat, hexagonally shaped auditorium, similar in furniture arrangement to the U.N. General Assembly, and professionally equipped television, radio, and motion-picture studios. Adjoining the academic section is a five-story hotel-restaurant wing which will

accommodate 300 persons. Participants in the Center's programs will be housed in this unit. Each hotel room will be equipped with an RCA Victor "Personal" television receiver for presentation of closed-circuit television programs relating to given conferences.

The television installation will include:

- 1) A 25-kw television broadcast transmitter (Type TT-25BH).
- 2) A custom-built 18-section RCA, VHF superturndial transmitting antenna, erected on a 910-foot guyed tower.
- 3) A television microwave relay system, linking the off-campus transmitter with the television studio in the Center.
- 4) 160 RCA Victor "Personal" 14-inch television receivers, which will be installed in the individual hotel rooms and linked by closed-circuit with the television studio.
- 5) Six RCA Victor black-and-white TV receivers and one color TV receiver, which will be located in various seminar and conference rooms for presentation of broadcast programs or special closed-circuit material originated in the studio.
- 6) Two live vidicon TV camera chains (TK-15), a film camera chain (TK-21), and two 16mm film projectors (TP-16F), for studio origination of live and filmed program material.
- 7) Master control, power, switching, and associated control room equipment for operation of both the closed-circuit and broadcast TV systems.

WISH and

WISH-TV

INDIANAPOLIS, INDIANA

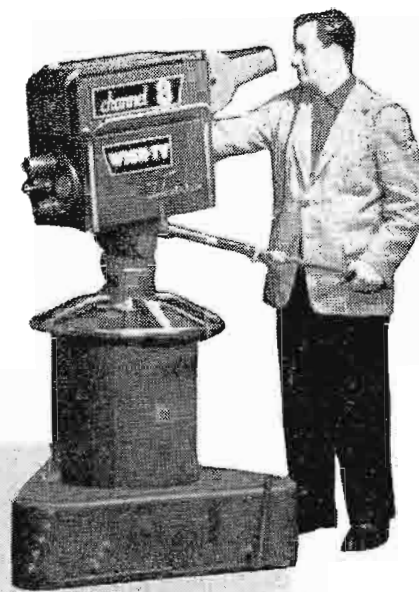

The installation and operation of WISH radio and television incorporates a number of novel features. Among these are the combined operation of radio and television transmitters from a common site with the radio towers used as support structures for the two television antennas; a custom RCA radio master control; a highly centralized television control; and modifications for rapid maintenance and operation.

WISH radio began operations on July 27, 1941. The studios and offices were located in the Board of Trade Building in midtown Indianapolis, and the transmitter plant was located on forty acres approximately two miles east of the city limit. The

studios and offices were moved, in 1950, to 1440 North Meridian Street to a building that was designed for radio and television occupancy. The original transmitter site is now serving both radio and television.

On January 28, 1954, the FCC finalized the grant for WISH-TV. Immediately the on-air target date for television was set for July 1, 1954. As will be detailed later, the studios were practically ready, however, all studio equipment had to be installed, a three floor addition made to the studio building for office and storage space, a new transmitter building constructed, and one radio tower dismantled and a new tower erected in its stead. The first drawing came off the board on February 27, 1954, leav-

ing approximately four months to the target date.

Making Target Date

A book could be written of the blood, sweat, and tears that went into the next four months, however, each station and project would have its share of these. Only a few will be cited. Although some of the difficulties appear as amusing in retrospect we were scarcely in convulsive laughter at the time.

The delivery schedule on most of the equipment for the transmitter plant was very tight. All hands had been given strict instruction that all delivery was to be made so that shipments would go directly to the

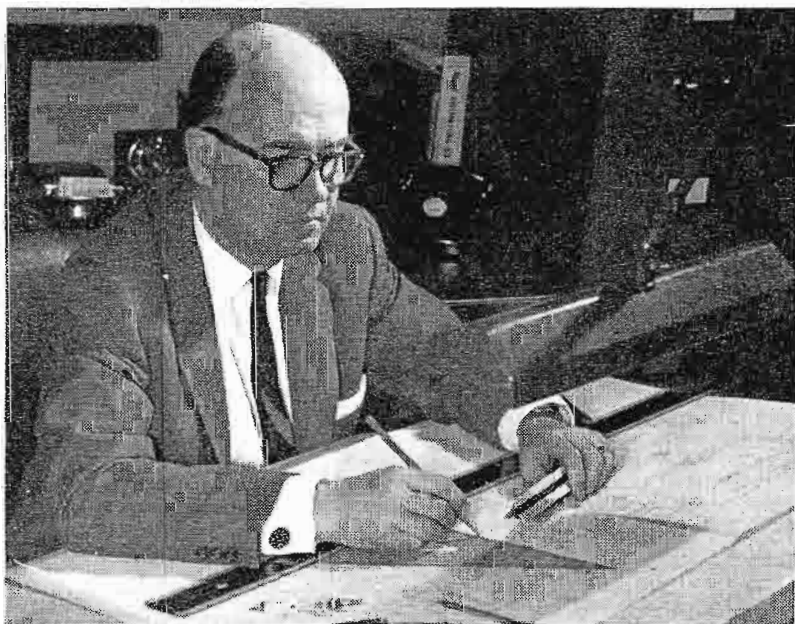

by **STOKES GRESHAM, JR.**,
Chief Engineer

and **ROBERT M. BROCKWAY**,
Assistant Chief Engineer

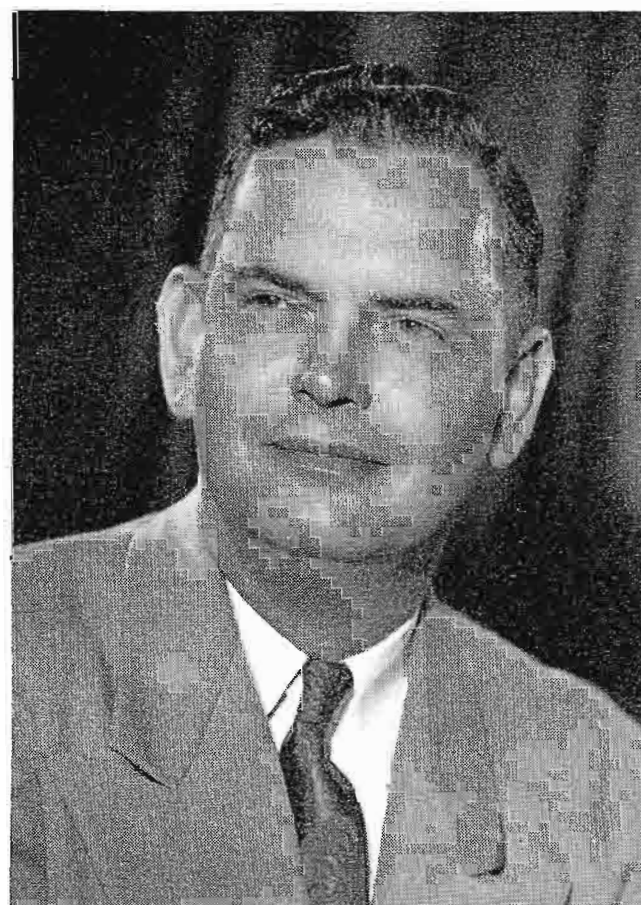

transmitter site, and would not first go to a local loading dock as is usually the case.

There was the instance where shipment was made, of critically needed items, by a method of transportation only a degree faster than transportation by wheelbarrow. Ten days of frantic effort located these items in Cincinnati.

The RCA Service Company representative arrived on June 1st. on schedule. Thirty days from announced air date only the shell of the transmitter building was complete, there was as yet no power available, and the only transmitter equipment on hand, and operative, was the 470-foot tower and antenna. The plumber had done a good job and the drinking fountain and toilet were operating at top efficiency.

The Service Company representative viewed and reviewed the situation (requiring something less than ten seconds) and advised that the proposed air date was hopeless, if not impossible, whereupon he made plane reservations for wherever such people hang out. We cancelled the reservation, and our good friends at the hotel in-

pounded his personal effects, if any. That convinced him the situation was not only possible, but probable.

Despite these vagrancies the service from RCA personnel was wonderful, and at times bordered on the fantastic. We began the testing of the 50 kw television transmitter six days prior to the target date, and as is usual certain parts have a life expectancy of a fraction of a second. This was no exception. At this point service was exceptional, to understate the case.

We had a courier making round trips between Camden and Indianapolis, by plane, bringing parts in a suitcase! For a time it seemed to be a losing battle. However, the marvel of the air age (plus the stamina of the courier) was triumphant. The parts on hand finally equaled the number of demised Indians. WISH-TV met the scheduled target date of July 1, 1954.

Transmitter Plant

In 1941 the RCA 5-DX radio transmitter, and associated equipment, was housed in a brick building approximately thirty

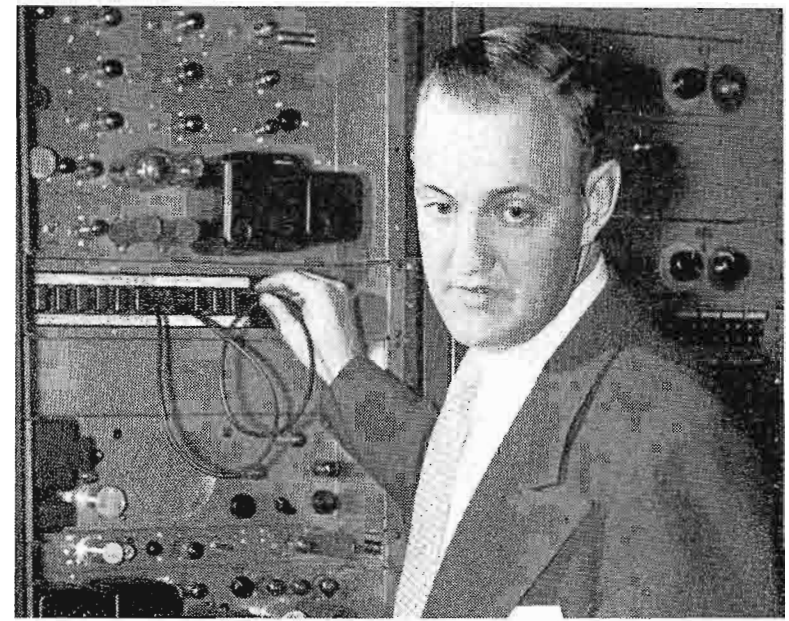

Roy Varda, Studio Supervisor.

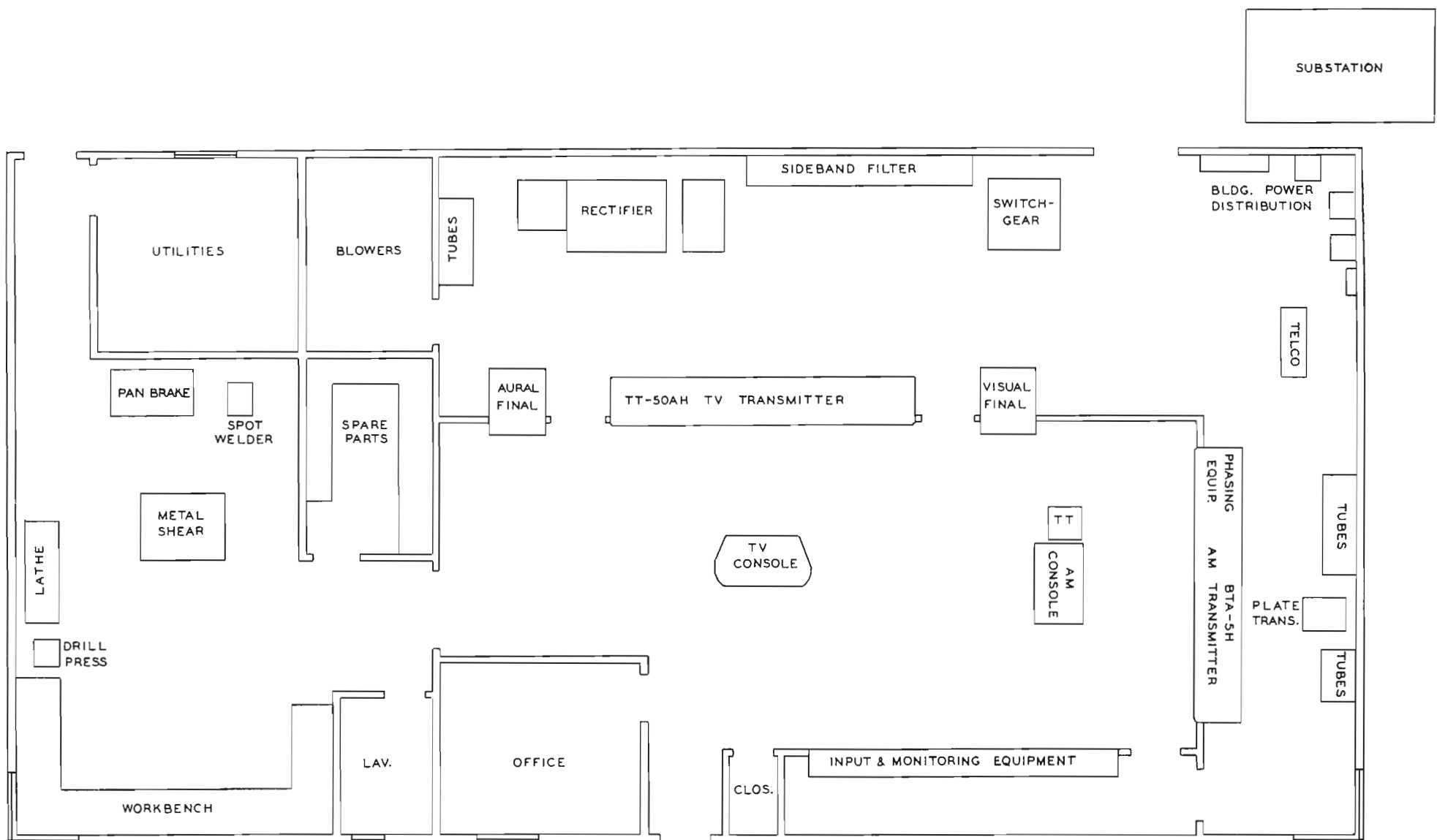

FIG. 1. Transmitter building floor plan.

feet square. The antenna array consisted of two guyed towers 470 feet high, spaced 547 feet apart. At the time these towers were the tallest structures in Indiana.

For economy of initial investment and operating efficiency it was decided to locate the television transmitter at the site of the radio transmitter. Since a television tower was to be installed, approximately 1000 feet high, it became necessary to solve certain problems affecting the radio operation. The proximity of the radio operation to some high gain video equipment likewise posed some problems.

A 1000 foot insulated tower was to be erected midway of the two existing 470 foot radio towers and used as the support structure for the TV antenna. Due to the nature of the WISH radio array it was possible (in theory) to place the 1000 foot tower in the array and ignore its existence. In practice only a small amount of detuning was required of the 1000 foot tower. This tower was completed approximately one year after WISH-TV began operations.

To meet the proposed air date it was necessary to remove the 470 foot north tower of the array, and erect a new tower over the same foundations that would support a twelve bay RCA Superturnstile antenna, and the associated transmission lines. The transmission lines were insulated from a point one quarter wave (at the

radio frequency) above ground, and then grounded at the base of the tower. This arrangement has proven very satisfactory, and the same method was used in the succeeding 1000 foot installation.

New Transmitter Building

A new transmitter building, forty feet by eighty feet, was constructed adjacent to the site of the proposed 1000 foot tower. This placed the transmitter approximately 250 feet from the base of the tower on which the temporary antenna was installed. Ultimately this tower and antenna would become an auxiliary, or stand-by, antenna.

Figure 1 is a floor plan of the transmitter building. Originally it was planned to move the RCA 5-DX transmitter from the old transmitter building, however, these plans were later modified and a new RCA BTA-5H radio transmitter was installed. This transmitter was installed in the spring of 1955.

The floor plan of Fig. 1 shows how the television and radio transmitters, together with the associated racks of audio and video equipment, are arranged in a "U." Ten racks are provided for associated equipment but, if we were making the installation over, experience indicates that 14 or 15 racks should be provided.

TV Transmitter Installation

In installing the RCA 50 KW, TT-

50AH, Television Transmitter the traditional method of installing the final amplifiers to the rear of the 10 kw section was abandoned. In the WISH-TV installation the 50 kw units were placed in line with the 10 kw section, and a wall built around the complete transmitter with two access doors located between the ends of the 10 kw unit and the final amplifiers on each end. This method of installation possesses the major advantages of materially reducing the operating room noise level, eliminating a large part of the transmitter heat from the operating room, and placing all meters under observation from the front.

The floor of the blower room is approximately three feet below the level of the remainder of the building. By this method it was possible to install blower ducts to the final amplifiers with only two elbows, and thereby afford a minimum restriction on airflow. The blower room is fully enclosed and sound treated to reduce noise in the operating room.

The noise level of a 50 kw television transmitter is quite high and this factor is frequently overlooked in the design of transmitter buildings. As a result audio monitoring is all but impossible. With the radio and television transmitters combined in a single operation the matter of noise level became doubly important. The transmitter operating room for WISH and WISH-TV is fully treated acoustically.

FIG. 2. WISH-TV TT-50AH Transmitter showing in-line arrangement of final amplifiers with driver units. (Distortion in picture is due to use of two negatives.)

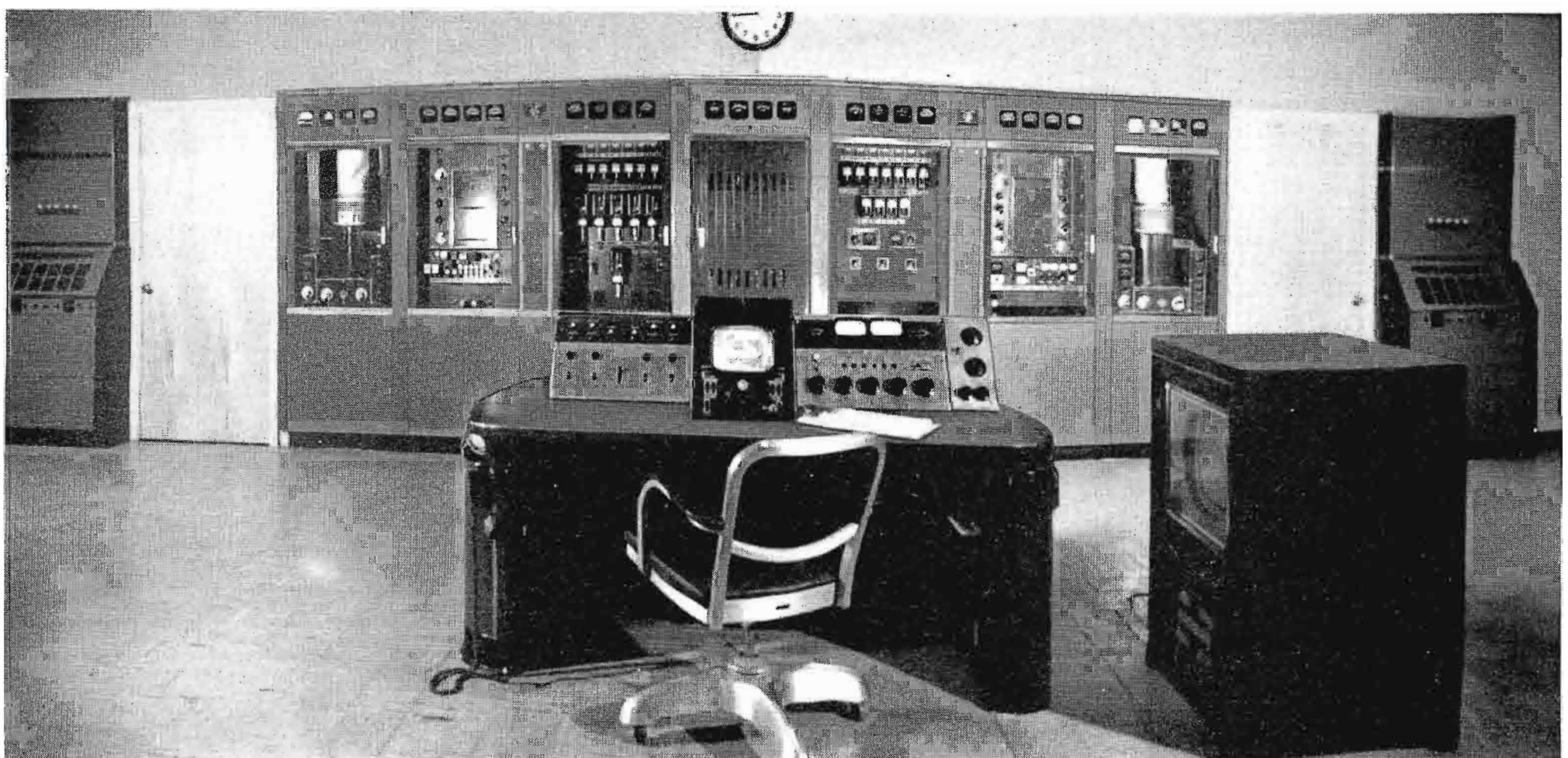



FIG. 3. View of transmitter room. TV console and portion of TV transmitter at left. AM console and portion of BTA-5H AM transmitter at upper right.

Figure 2 shows the in-line arrangement of the TT-50AH Television Transmitter, and the associated control console. A color monitor is to the right of the control console. The photograph is slightly distorted due to the necessity of using two pictures to obtain a composite.

Figure 3 is a close-up of the TV control console and monitors. The monitors are on a cabinet, built in the station shop, that is movable by casters. A portion of the radio transmitter and console are seen to the right.

A portion of the side-band filter (vertically wall mounted), the dummy load, high voltage transformer, rectifier cubicle, and the glass enclosed tube storage cabinet are seen in Fig. 4. To the upper right of the photograph are the transmission lines (no connection in picture) from the auxiliary tower. Switching from the main antenna to the auxiliary requires about four minutes, and is accomplished by loosening two elbows on each line. Proper phasing is maintained at these connection points.

A front view of the RCA BTA-5H Radio Transmitter, and associated phasing

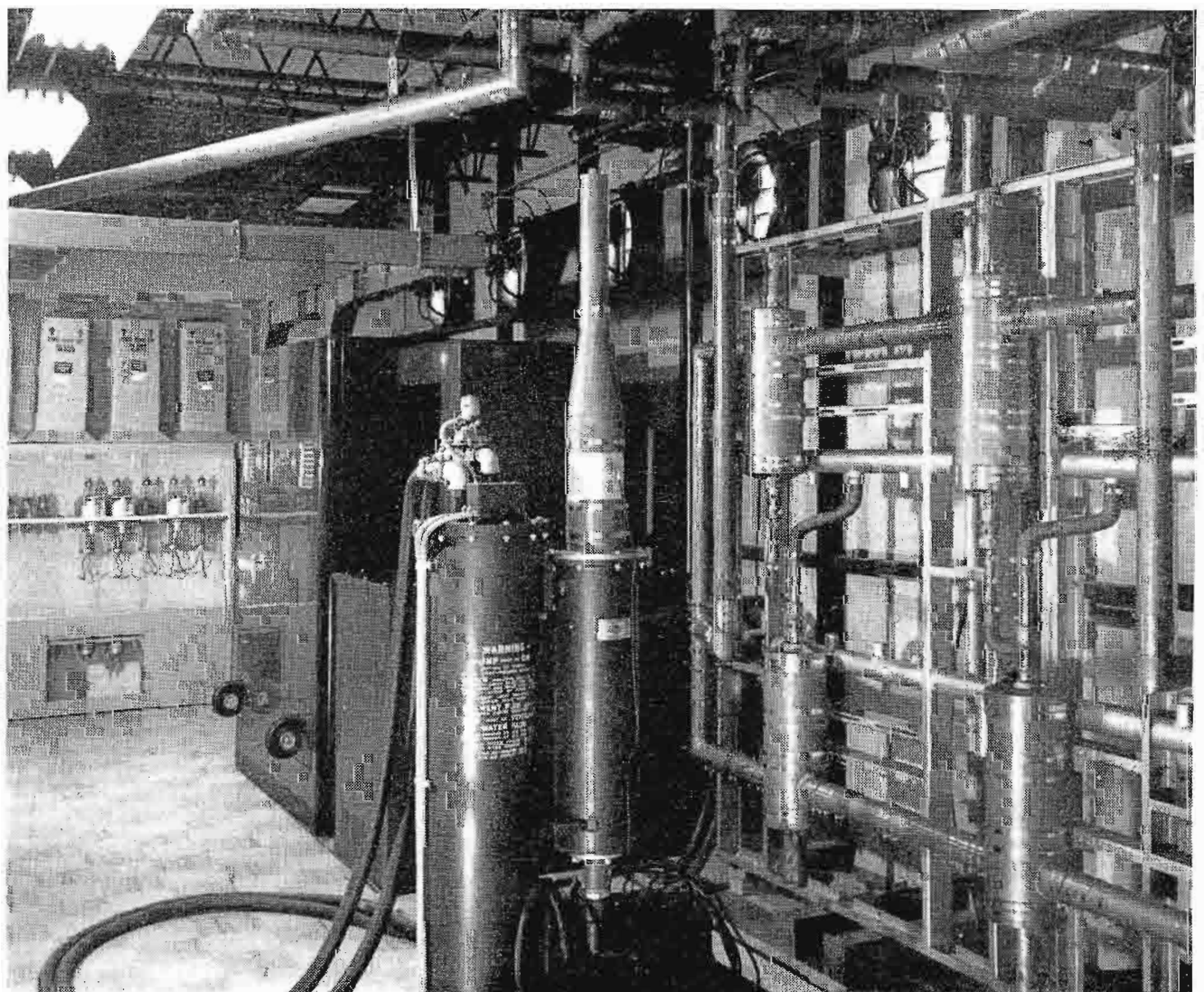

FIG. 4. Area behind TV transmitter. Left to right, spare tube cabinet, high-voltage rectifier, dummy load, and portion of vestigial sideband filter.

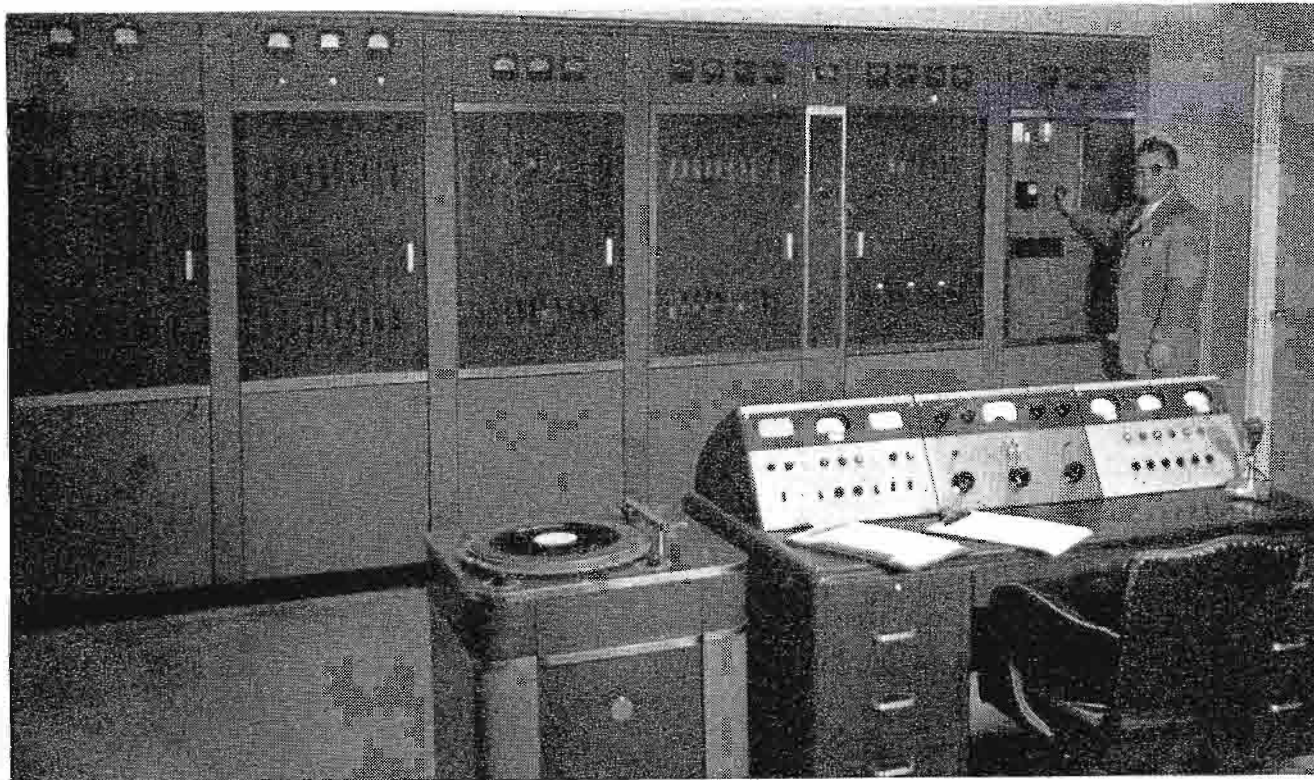

FIG. 5. View of BTA-5H AM transmitter and console. Two cabinets at left are phasing equipment. Right-hand console turret contains control for switching each of the three AM transmission lines to a spare line. Engineer in picture is B. J. Weimer, Transmitter Supervisor.

equipment, is shown in Fig. 5. The phasing equipment is contained in the two units on the left.

Figure 6 is a front view of the ten racks containing audio and video equipment associated with the two transmitters. The three racks to the left are primarily radio, and the remaining seven racks are primarily associated with television. Certain audio items are interchangeable between radio and television. For this photograph the doors were removed.

Maintenance Facilities

The plan of the transmitter workshop is shown in Fig. 1. The workbench is in a "U" and approximately twenty-four feet of work area is provided. In addition to the usual supply of small hand tools the workshop contains extensive metal-working facilities. There is a metal-turning lathe, a 12 kw electric arc welder, a four-foot metal shear, a pan break, a drill press, and various smaller tools used in metal work. The shop is capable of machining practically

any part that may be required for emergency operation of either transmitter. An eight inch table saw is available for wood working.

The operating room, shop, and office are air conditioned. Due to the enclosed wall construction for the transmitters and associated equipment very little heat is released from the equipment to other areas. Exhaust fans remove the heat from the rear of the equipment. During the winter the heat from the equipment is used in heating the building with an assist in very cold weather from an oil-fired furnace.

Figure 7 is an aerial view of the transmitter property, showing the three towers, transmission lines, and building. The original TV antenna (now a stand-by) can be seen on the north tower (to left), with the main TV antenna on the center tower. Since WISH operates directionally at night, only the south tower (to right) is used for radio operation during the day. During this time the other two towers are "cold" and permits maintenance and inspection during the day. The transmission lines, both radio and television, are suspended in the horizontal run on arms attached to telephone-type poles.

A 24 hour watch is maintained on the transmitter plant to insure adequate maintenance and servicing of both radio and television transmitters. Every item in the plant is serviced and inspected at not more than three month intervals. Critical items are serviced and inspected on a daily or weekly basis.

FIG. 6. Input and monitoring racks for WISH and WISH-TV transmitter plant. Doors have been removed for photographing.

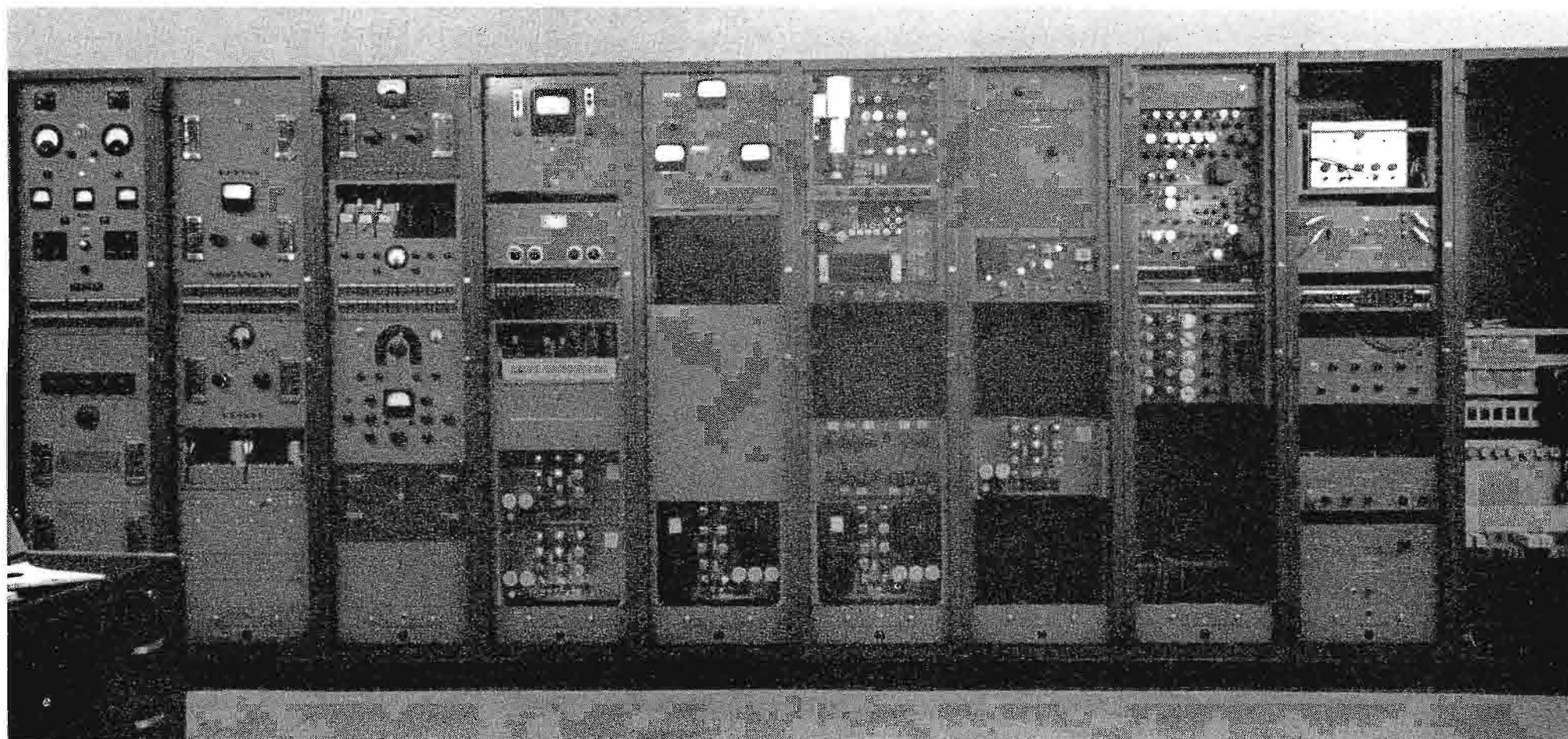

Operating a radio and television transmitter from the same location presents some difficulties in initial installation. Despite certain misgivings among the fraternity when we announced our intention for such an operation we have found it very satisfactory and advantageous. The difficulties encountered will be proportional to the relative field (power) of the radio transmitter, however, good design practices and adequate attention to shielding and grounding will eliminate the major source of trouble.

Studio Plant

The studios and offices of WISH and WISH-TV occupy the entire second floor and portions of the first and third floors of the Riddick Building, just north of the central business district of Indianapolis. All of the 18,500 square feet of space used by the stations today was expressly planned for radio and television. The building was designed in 1948, six years before WISH-TV became a reality, however, the space provided for television has worked amazingly well. The original space provided was 12,500 square feet and used exclusively for radio, with certain additions planned for television.

The first addition to the building was erected in the spring of 1954 to provide an additional 5000 square feet for WISH-TV. This three-story addition was placed at the rear of the original building and contains, on the first floor, a room for building maintenance and services, plus the film department; the entire second floor of the addition is a prop storage area; and the third floor is devoted to offices.

A second addition to the building was completed in the summer of 1956 to provide additional room for engineering equipment and maintenance shop. This area of 1000 square feet is located on the third floor directly above the television control area. A stairway gives ready access between these closely associated areas.

Visitors to WISH and WISH-TV are received in the lobby which is at the Meridian Street end of the building. On opposite sides of the reception lobby are glass windows through which may be seen the radio master control room and the newsroom. Opening off the lobby are sound-

FIG. 7. Aerial view of transmitter site looking east. 1,000 foot TV tower in center. Other towers are 570 feet. Tower at left mounts the emergency TF-12AH antenna for WISH-TV. Regular antenna on 1,000 foot tower is TF-12BH. Although clearly discernible in picture, the center tower is electrically non-existent in the night-time directional array.

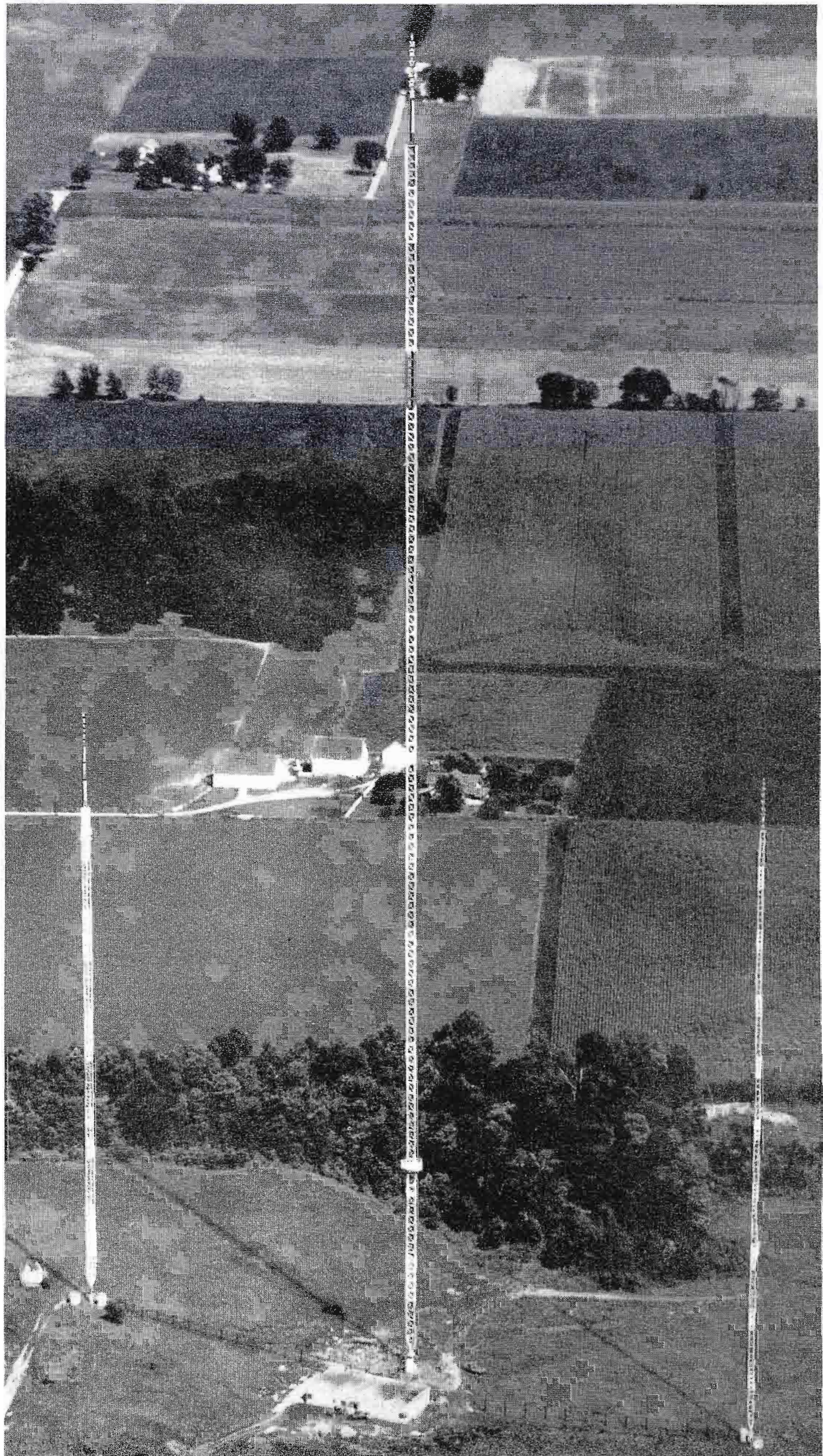



FIG. 8. Radio Studio B and AM master control room from Studio C. Portion of recording room through window at right.

locks leading into all four studios; this feature is very desirable due to the ease in which studio guests may be handled. Two main corridors lead from the lobby to the executive offices and to the television operations area respectively. The well-appointed client room is adjacent to the lobby and is equipped with high-fidelity aural monitoring facilities, visual monitor for air- and closed-circuit viewing, and 16 mm projection equipment for motion-picture screening.

Radio Operation

Two of the four studios, Studios A and D, are equipped for television originations; all four studios are available for radio programs. With the exception of Studio D, all studios may be observed from the radio master control desk. What is nominally the radio portion of the plant includes Studio B (Fig. 8), Studio C, radio master control, and the recording room. The floor plan of Fig. 9 shows the studio and office arrangement.

WISH maintains extensive remote facilities because it is not uncommon for a majority of the station's programs to originate outside of the studios which includes many of our "dee-jay" shows. When the record shows originate from the station, Studio B is used. "Live" programs are assigned to Studio C, the only other studio not equipped for television.

Radio Master Control

The heart of the radio operation is the Master Control Room (Fig. 10) which is rather unique in the fact that it has provided adequate facilities through numerous and varied programming "trends" over the years without any loss of efficiency of its many functions. The control board was conceived in 1940 by Stokes Gresham, Jr., Chief Engineer of WISH and WISH-TV. Mr. Gresham's ideas were transmitted to the RCA Broadcast Equipment plant, which was then located in Indianapolis, and it was built by RCA to his specifications. The built-in flexibility of the system is the basis for our belief that it will never become obsolete or outmoded.

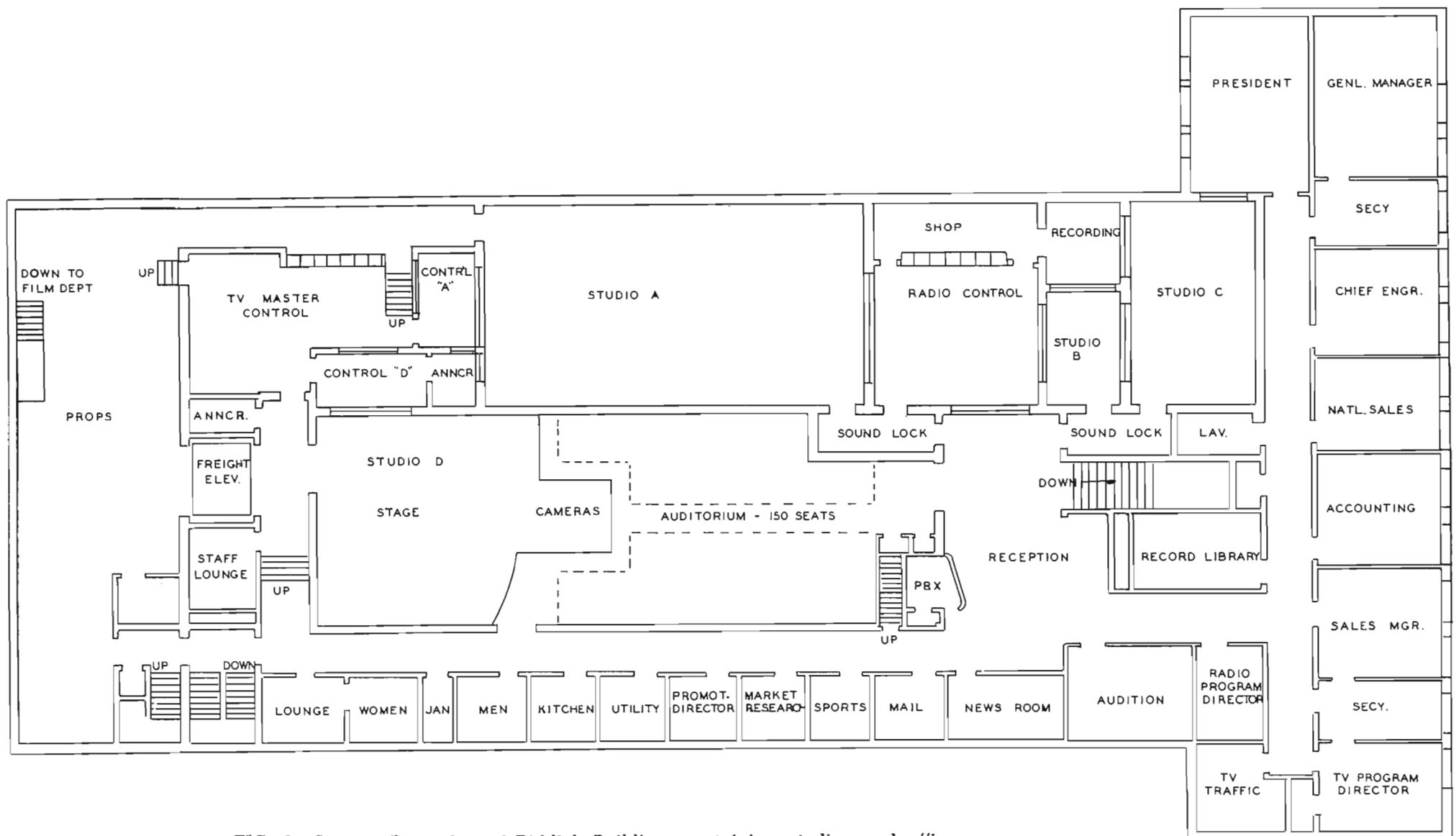

FIG. 9. Second floor plan of Riddick Building, containing studios and offices.

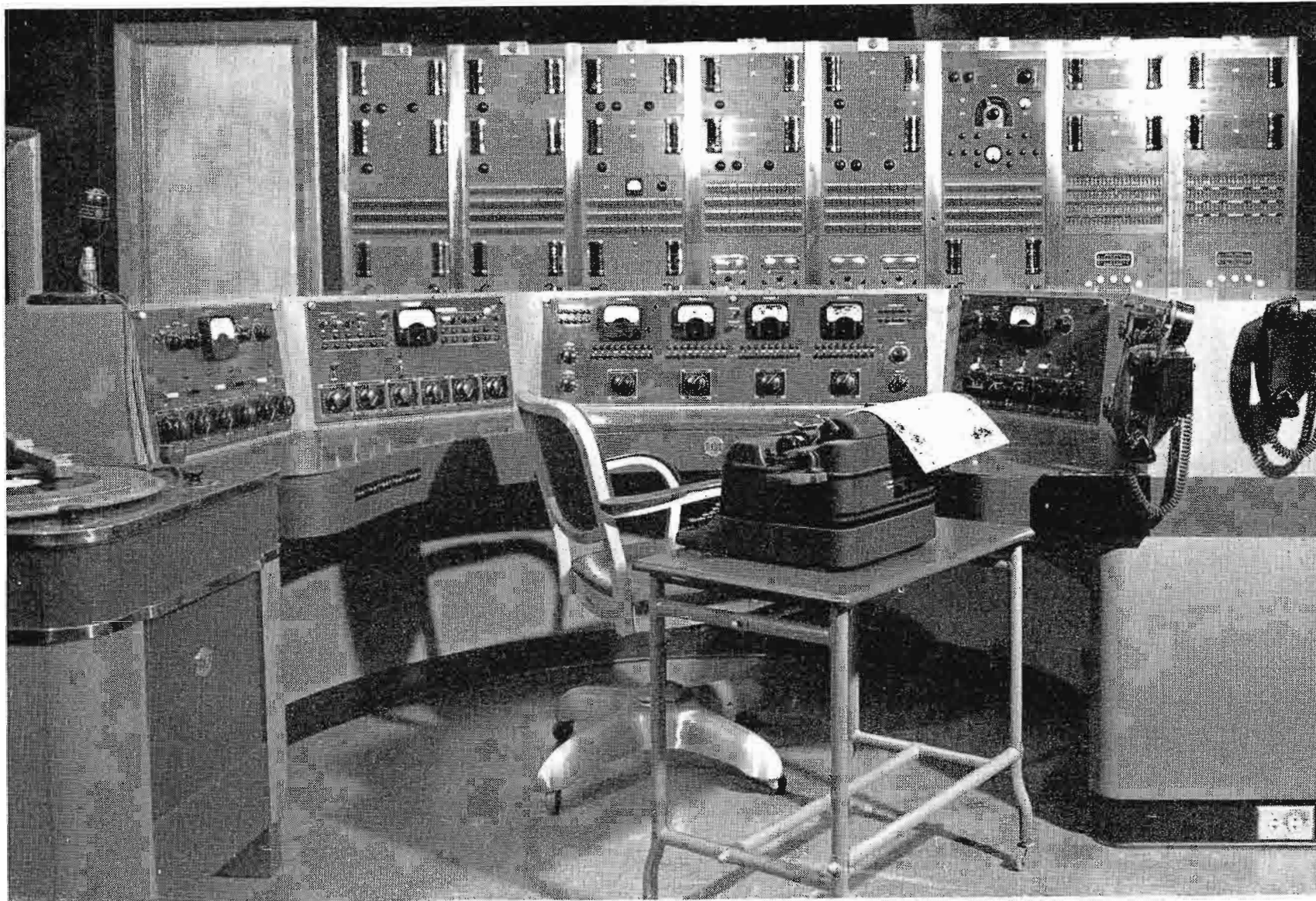

FIG. 10. Radio master control viewed from lobby.

In appearance, the semicircular control desk and the audio equipment racks resemble those of a number of radio stations that have installed RCA custom-built studio controls. The central panel of the desk contains switching equipment for the four outgoing channels. On either side of the center panel are four mixing panels arranged in pairs, one each for Studio A, Studio B, Studio C, and Master Control; this latter panel used for remote and network pickups.

The master control system was designed for ease of operation during emergency conditions. To minimize the time spent in patching when a failure occurs, as many circuits as possible were extended to push buttons on the master control console with the result that an entire channel may be substituted immediately by a push button without a time-consuming trip to the patch-bay. To facilitate normal operation, a number of remotes may be patched to keys on the desk in advance of periods of extensive remote switching. The system is arranged so that the engineer may transmit program material via several different "routes" at his discretion. A full description of the WISH radio master control system is beyond the scope of this article; but its high state of flexibility has proved

that the more flexibility that can be designed into a system, the longer the system will serve the station.

TV Operation

The foregoing description of the radio master control expresses the WISH philosophy of "centralized control" which was incorporated into the design of the WISH-TV studio plant. The WISH-TV studio facilities are now in their second stage—color telecasting; the first being monochrome. When the studio building was planned in 1948, television broadcasting was limited to a handful of stations using for the most part, experimental and composite equipment; color television was unheard of. Despite this lack of information relative to the size and appearance of television equipment, space was provided in the proposed building for television control and projection. The early months of 1954 brought forth a veritable army of carpenters, electricians, and other building tradesmen to 1440 N. Meridian Street. Like the proverbial walls of Jericho, some of our walls came tumbling down and new ones erected. The finished product was a very compact, centralized control area in that section of the building assigned to future television facilities some six years previously.

The WISH-TV technical area consists of three adjacent control rooms: the master control, and subcontrols for Studios A and D. Each studio and its associated subcontrol room is an independent production entity, however, the physical layout of the plant is such that extremely close coordination is achieved between the two subcontrols and the master control.

One of the basic philosophies employed in the design of the WISH-TV plant was the elimination of operating "bottlenecks" which prevailed in some stations of comparable size which had been built in the earlier days of television—we were not interested primarily in what *could* be done, rather, what should *not* be done. It was with this thought in mind that the system was designed.

Anticipating Color TV

In the initial stage of the layout, all of the video and audio equipment was located in the master control. When we went on the air in July, 1954 we had adequate facilities for monochrome transmission and we had a plant that would be expandable when necessary without sacrificing any of the monochrome functions. With the addition of color equipment, the anticipated expansion came in 1956. The color equip-

FIG. 11. Third floor plan.

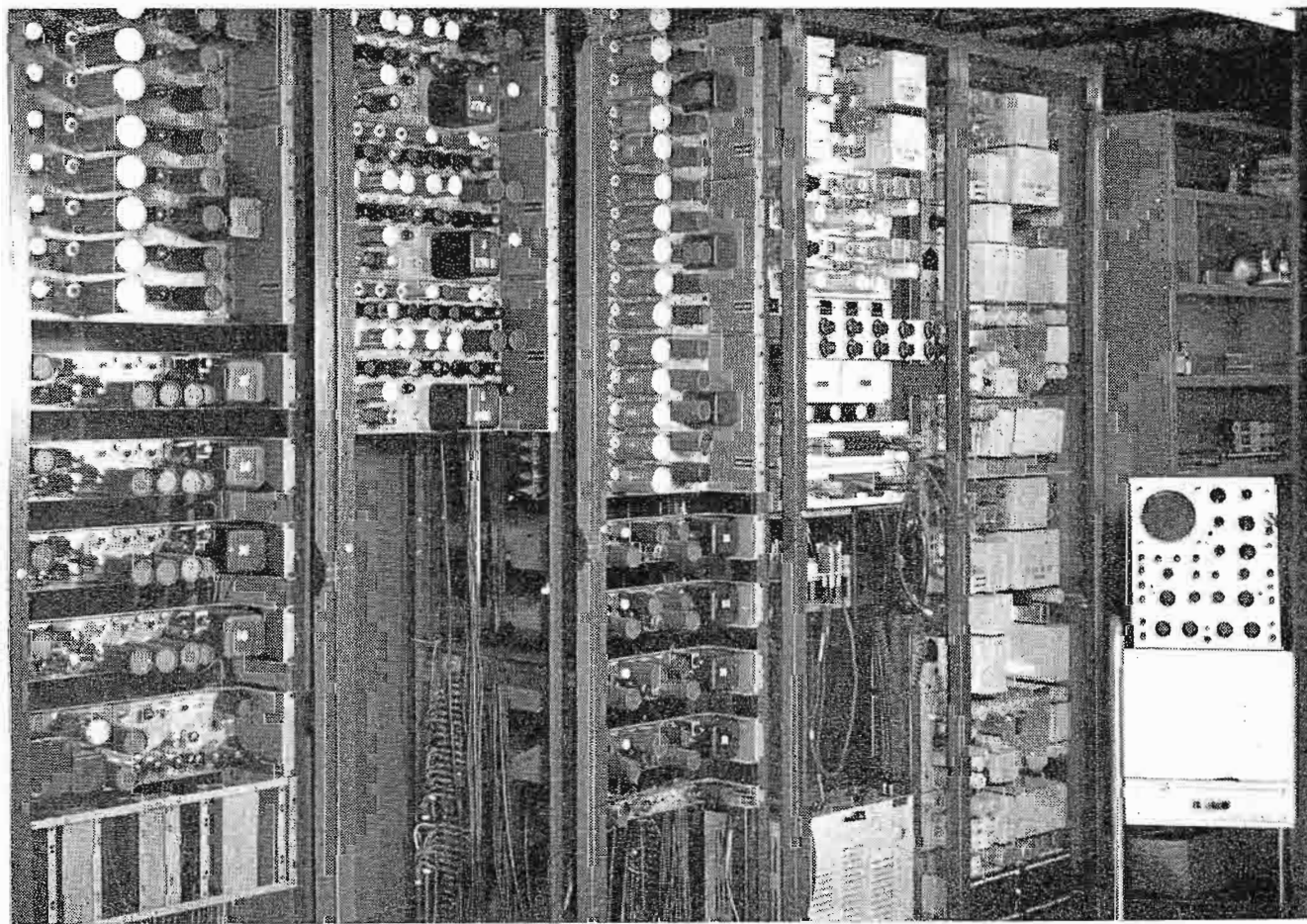
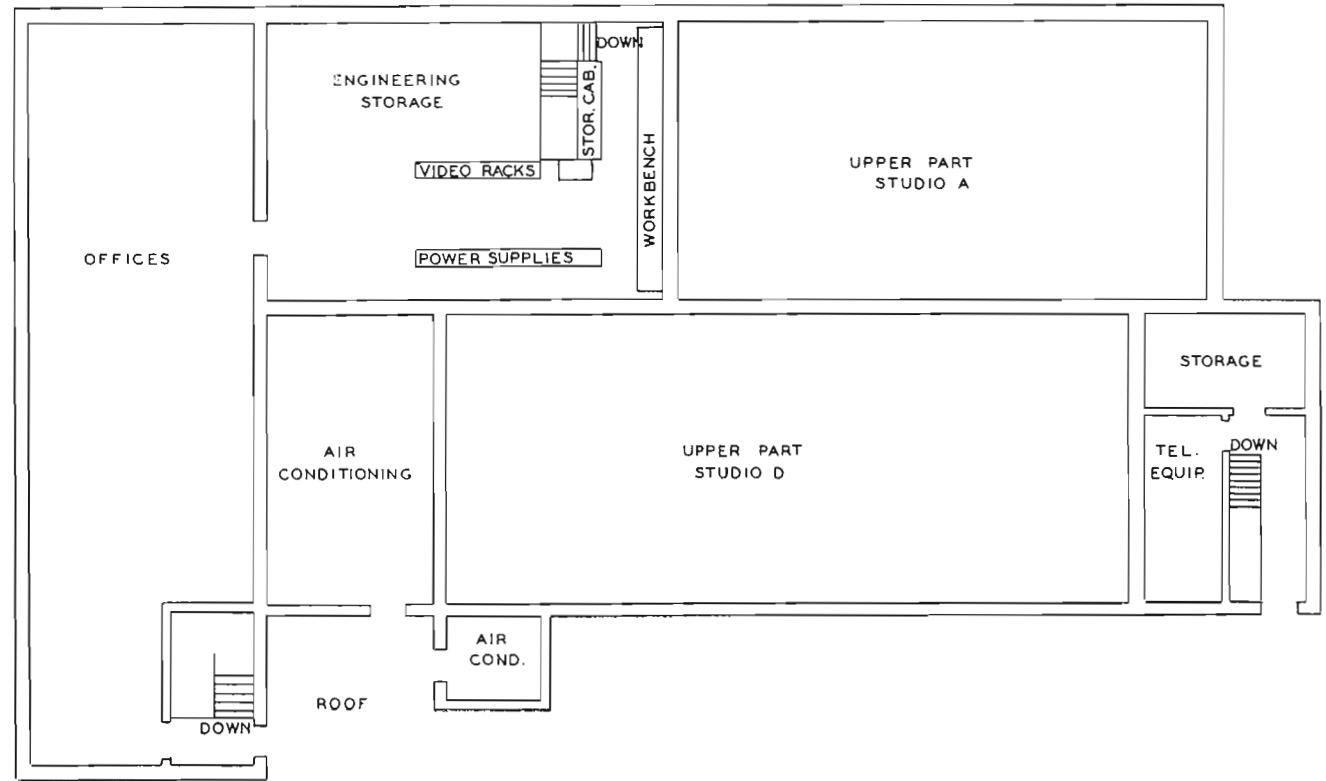
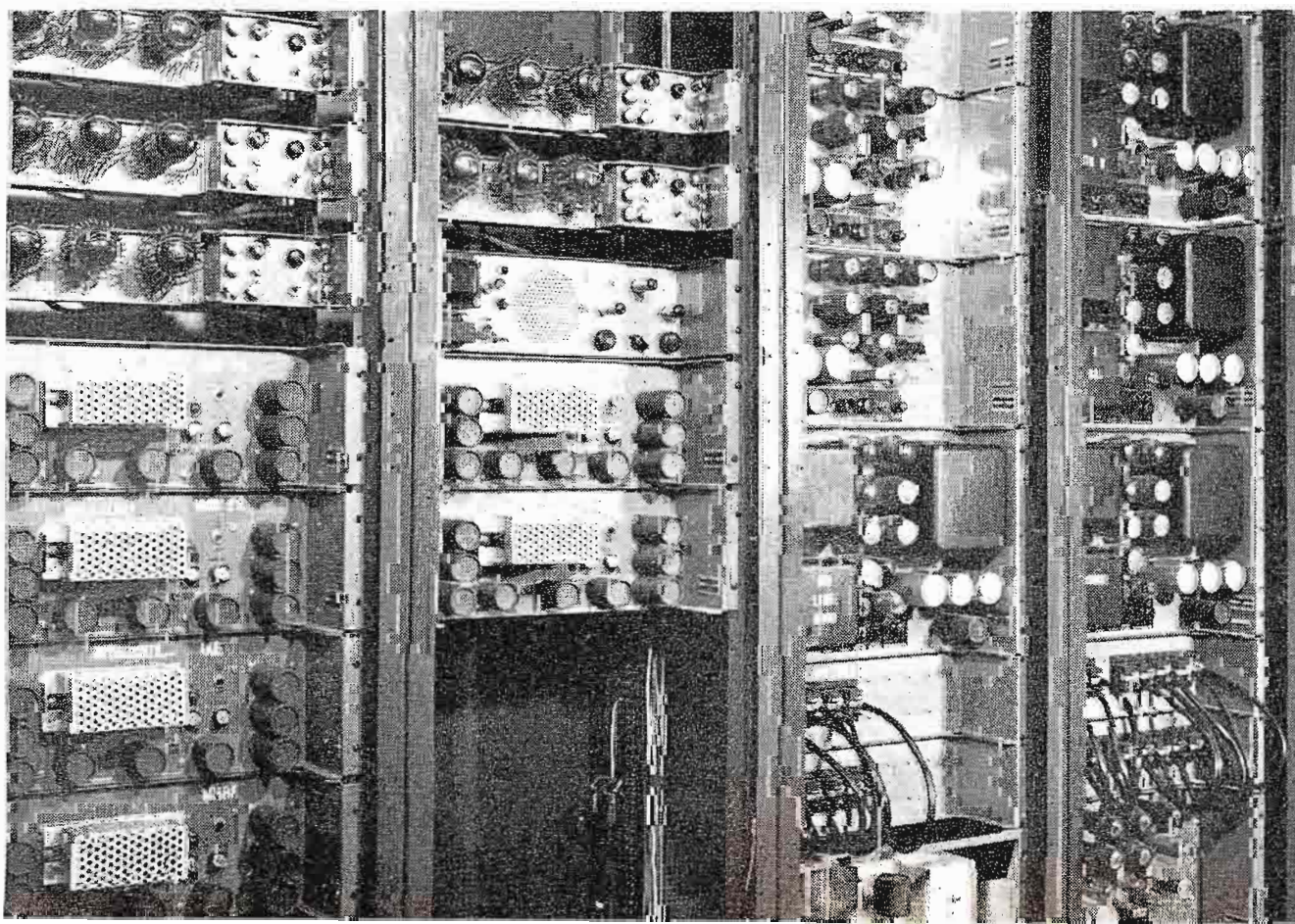

FIG. 12. Video racks on third floor. Left to right, pulse distribution amplifiers, stabilizing amplifiers, video distribution amplifiers, two Telco terminal racks.

ment was integrated into the existing system as additional facilities without affecting the operating efficiency of the balance of the system. With the addition of the present color equipment, the expandability of the plant was not exhausted and plans are currently being made for addition of a video tape recorder later in 1957.

To provide space for additional equipment necessary for color telecasting, we made the second addition to the building, a room on the third floor directly above the television control area. This is shown in Fig. 11 and includes the TV maintenance shop; tube-and-part storage; and equipment racks. Figure 12 shows a portion of these racks which contain video and pulse amplifiers and Telco terminal equipment. The balance of the third floor racks (Fig. 13) are for video-equipment power supplies.



Each subcontrol is the working area for the producer-director, audio engineer, and technical director. Figure 14 was taken from TV master control and shows a program in progress in Studio A with a portion of the subcontrol in the foreground. Audio facilities for the subcontrols, not shown, are standard consolettes. Video facilities for monitoring and switching are mounted in an RCA TC-5 Program Director's Console in each control room which has five TM-2 Monitors for previewing

FIG. 13. Third floor power supply racks. Shows mounting of power supply patch panels.

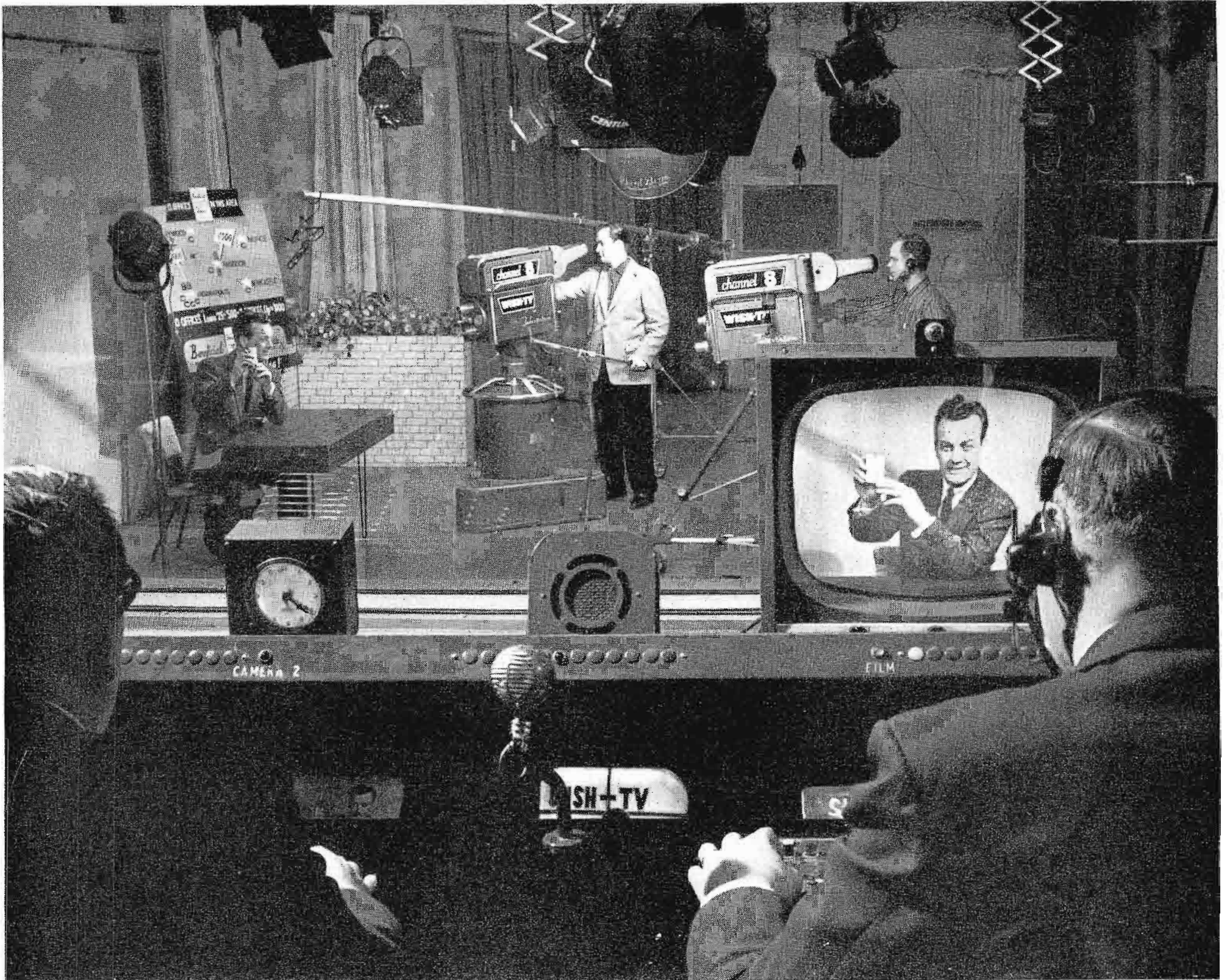

FIG. 14. Studio A from subcontrol room. In left foreground, Producer-Director; at right, Technical Director.

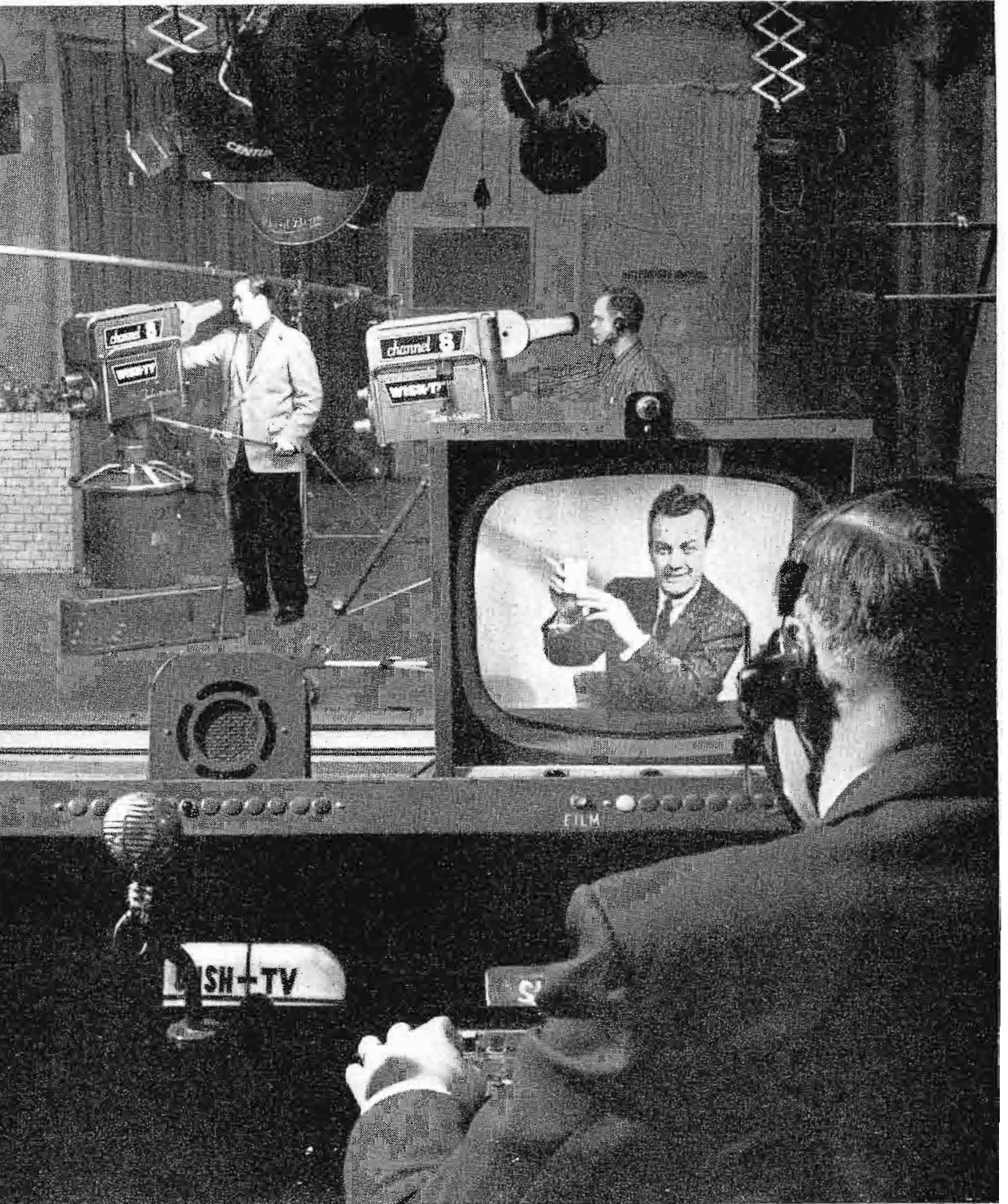
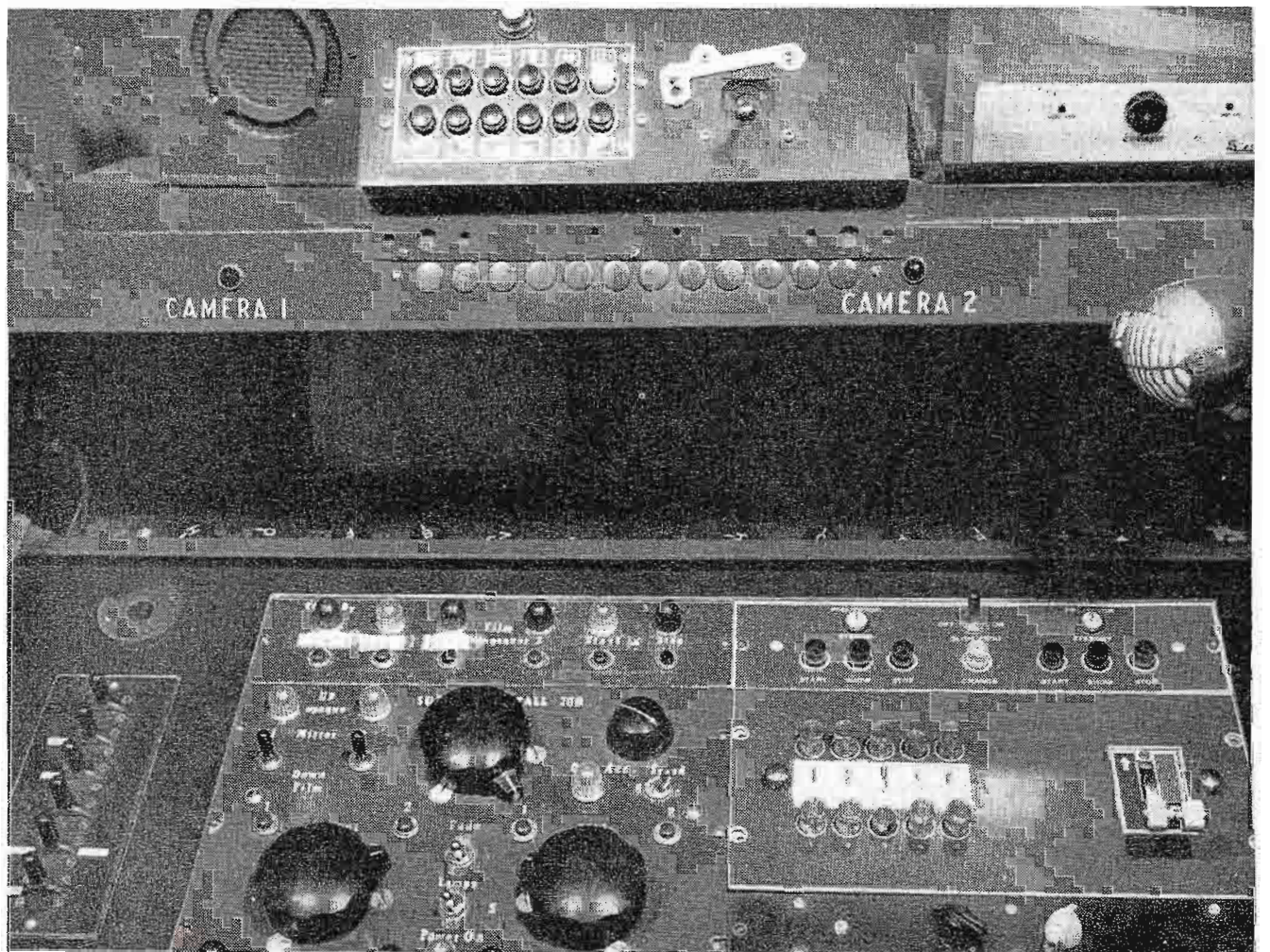

FIG. 15. Closeup of WISH-TV subcontrol console showing Technical Director's position. At top is control panel for video effects equipment. Keys at left for plant intercom. Center panels for remote control of monochrome projector No. 3, slides, and opaques. Right hand panels from top to bottom: projector controls for color projectors, TS-5 switcher, and switching panel (black and white knobs) for connecting video into effects equipment.

the inputs to the TS-5 Switcher; two cameras, two film chains, and effects or network. The monitor for the studio output is above the console.

Program control equipment for use of the technical directors is shown in Fig. 15; these controls are duplicated in both control rooms; master control has an additional set of projection controls. Shown are the TS-5 Video Switcher, control for the effects equipment, and projection control equipment. The RCA MI-26256 Projector Control Panel was modified at WISH-TV to operate in conjunction with a TP-15 Multiplexer. With these panels, plus the Projectall panels shown, the technical director has full control of films, slides, and opaques. Each of the three control points in the plant has similar controls: only one



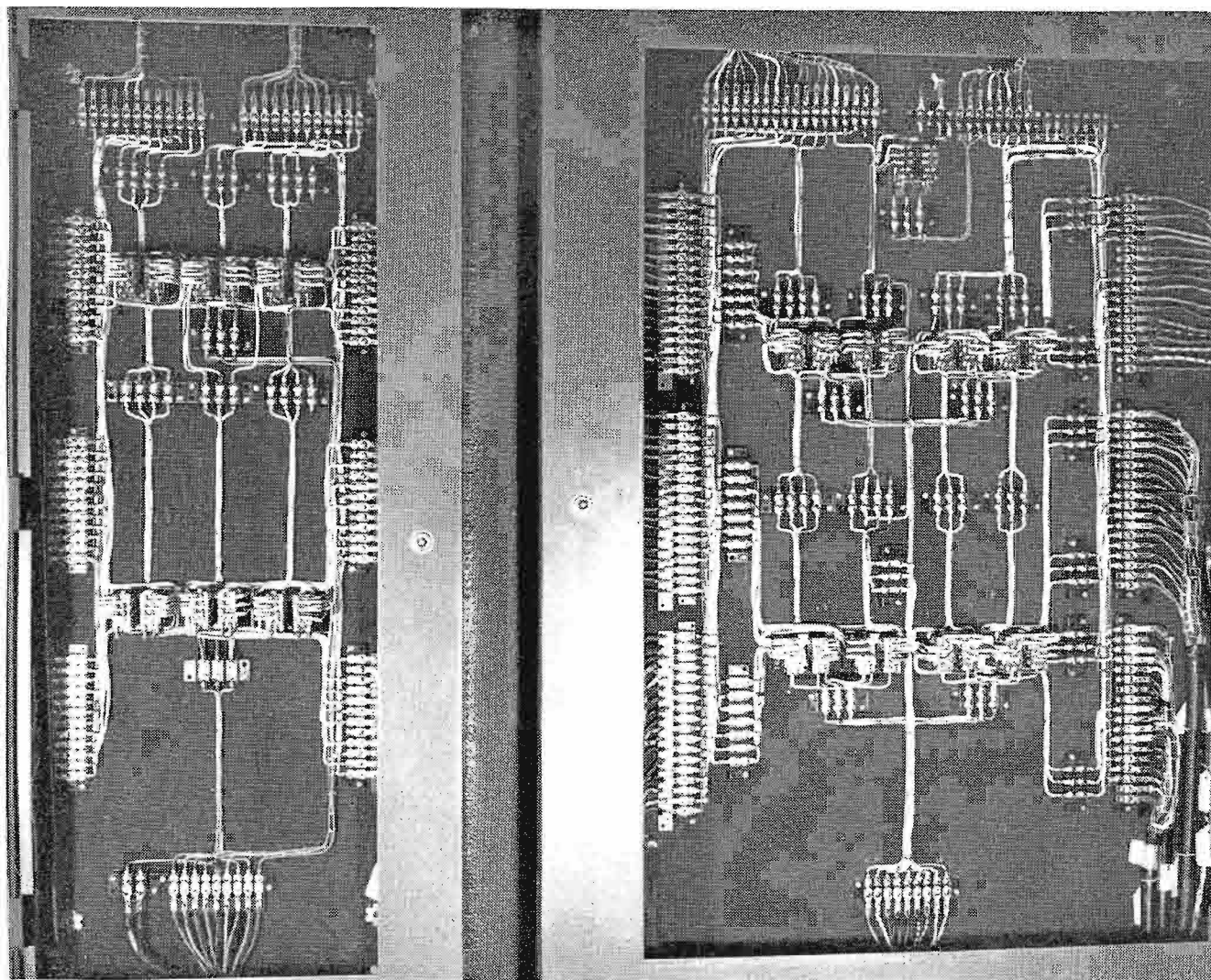

FIG. 16. Relay panels for transferring remote control to three control consoles. Panel at left is for the TP-15 multiplexer and color projectors, panel at right for Projectall and monochrome projector. Relays are 4-pole double throw latching relays.

set of panels is energized at a time. Delegation of control of projection facilities is a master control function and is controlled by a relay system shown in Fig. 16. To facilitate trouble shooting, all circuits appear on barrier terminals and an 18-color code is used in the wiring. The two film chains may be delegated simultaneously to one control or split between two controls and assigned separately.

Film Facilities

Projection facilities (Fig. 17) at WISH-TV are located in one end of the TV master control (Fig. 18). This is contrary to the standard practice of locating projection in a separate room, but we feel that the advantages of such an arrangement as we have far outweigh the disadvantages, primarily that of a higher ambient noise level in MC caused by the projectors running.

The principal advantage of locating the projectors in master control is again—centralization. It permits direct personal contact between the projectionist and the master control engineer; when trouble occurs in either area, at least two men are available for immediate attention. The fact that the master control (and projection) are adjacent to the subcontrols, close liaison between the technical directors and projection is likewise achieved.

Projection equipment at WISH-TV includes three TP-6 Projectors, two of which are modified for color film; two camera chains: a TK-20 Iconoscope Camera, and a TK-26, 3-V Color Chain. Color projectors No. 1 and No. 2 and a TP-3 Slide Projector multiplex into the 3-V camera by means of a TP-15 Multiplexer. For monochrome transmission, one "V" of the 3-V is used. A Projectall slide and opaque projector and TP-6 No. 3 are used in conjunction with the TK-20D.

TV Master Control

As the master control desk is the "heart" of the radio operation; likewise, the master control console in the television control (Fig. 19) is the control center for WISH-TV. Camera shading, station switching, and complete program control are functions of the master control engineer. Again, our policy of centralized control is at once apparent for all video and audio levels are maintained at one location. Station switching, as opposed to camera switching, is performed at the master control position utilizing a modified TC-4 Audio/Video Switcher.

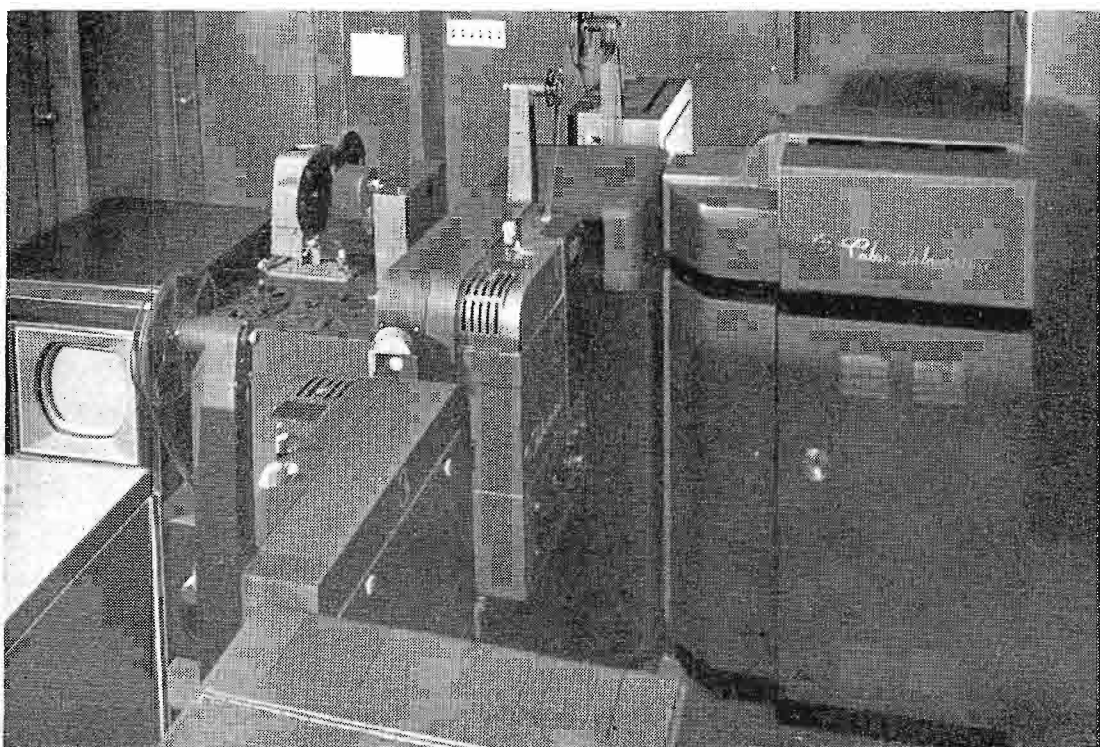

FIG. 17A. View of WISH-TV projection equipment. In foreground, TK-20D iconoscope camera. In background, TP-3 slide projector, TP-15 multiplexer, and TK-26 3-V color camera.

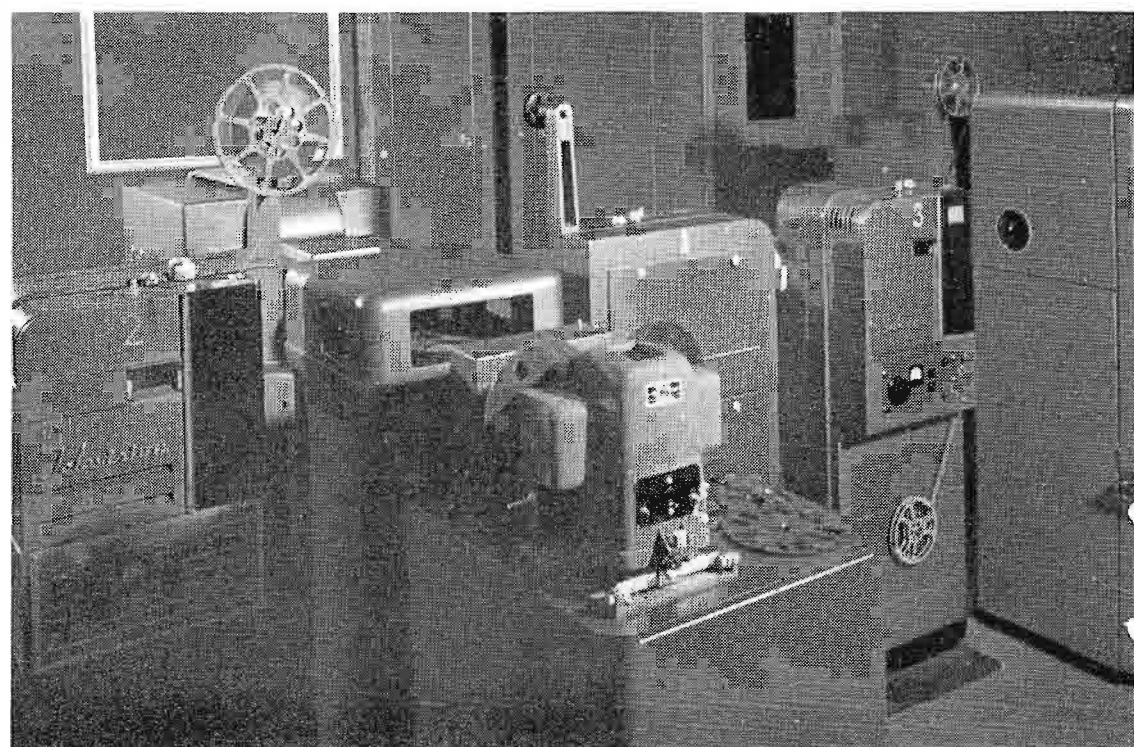

FIG. 17B. View of WISH-TV projection equipment. At left are color film facilities. At right are monochrome facilities. At extreme right is Projectall for slides and opaques.

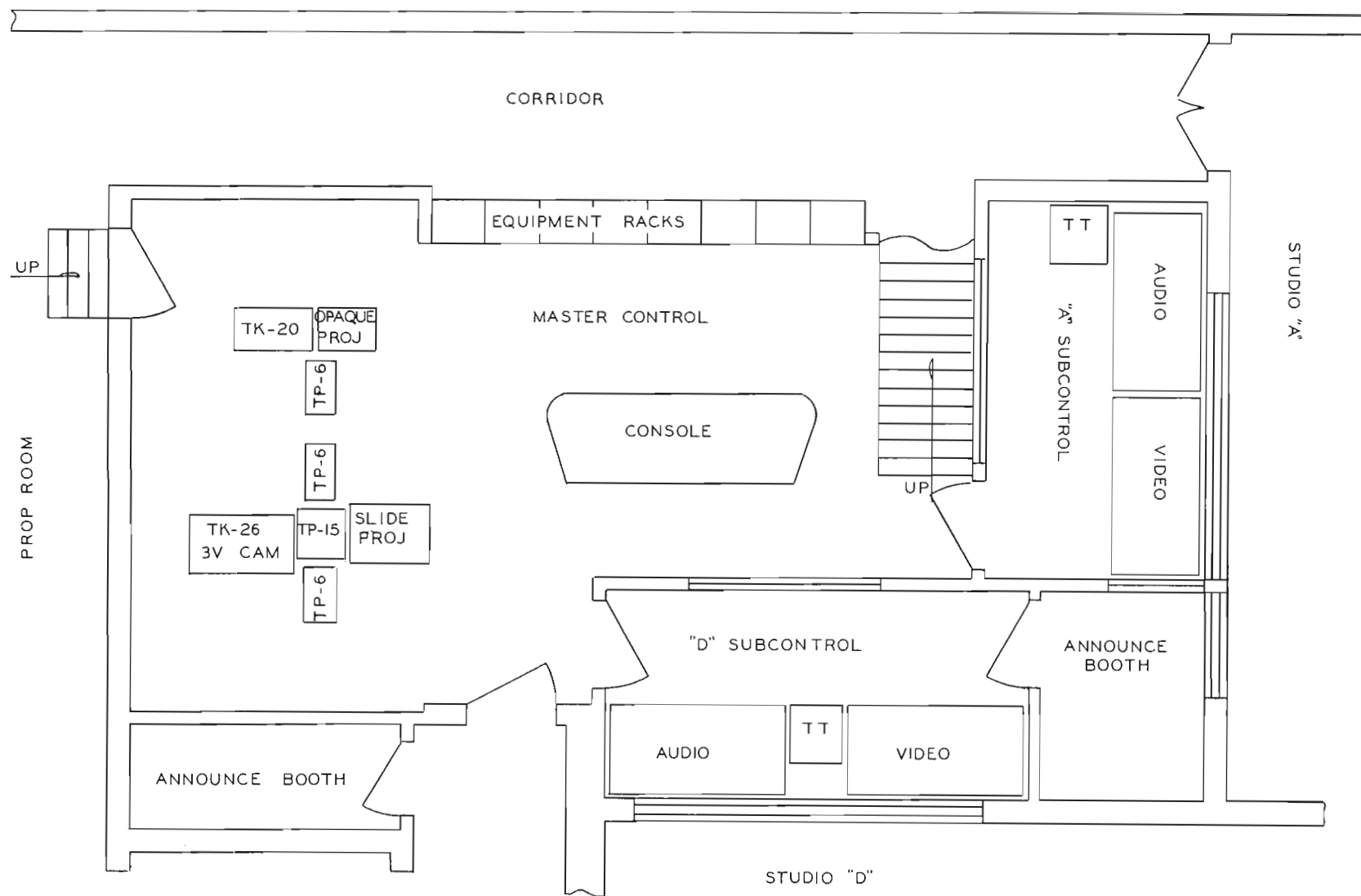

FIG. 18. Floor plan TV control area.

Immediately behind the master control engineer's position are additional equipment racks containing such video equipment as requires frequent adjustment. These racks also contain the video patch fields and two audio racks. When the 3-V chain was installed, we chose the option of having the control equipment rack-mounted and have found that this was a wise choice inasmuch as having additional length on the console would not be desirable. Figure 20 shows the master control racks.

Helps for Programming

Studio A (Fig. 9) has a floor area of 1300 square feet and is the "working" studio for WISH-TV. It is arranged to permit several back-to-back shows to be pre-set. Lighting units are divided between a permanent grid-iron and three Century Mobilrails which run the length of the studio. Each Mobilrail accommodates six movable fixtures which adds flexibility to set lighting. Studio A was formerly used as a radio studio and offers perfect acoustics for TV audio.

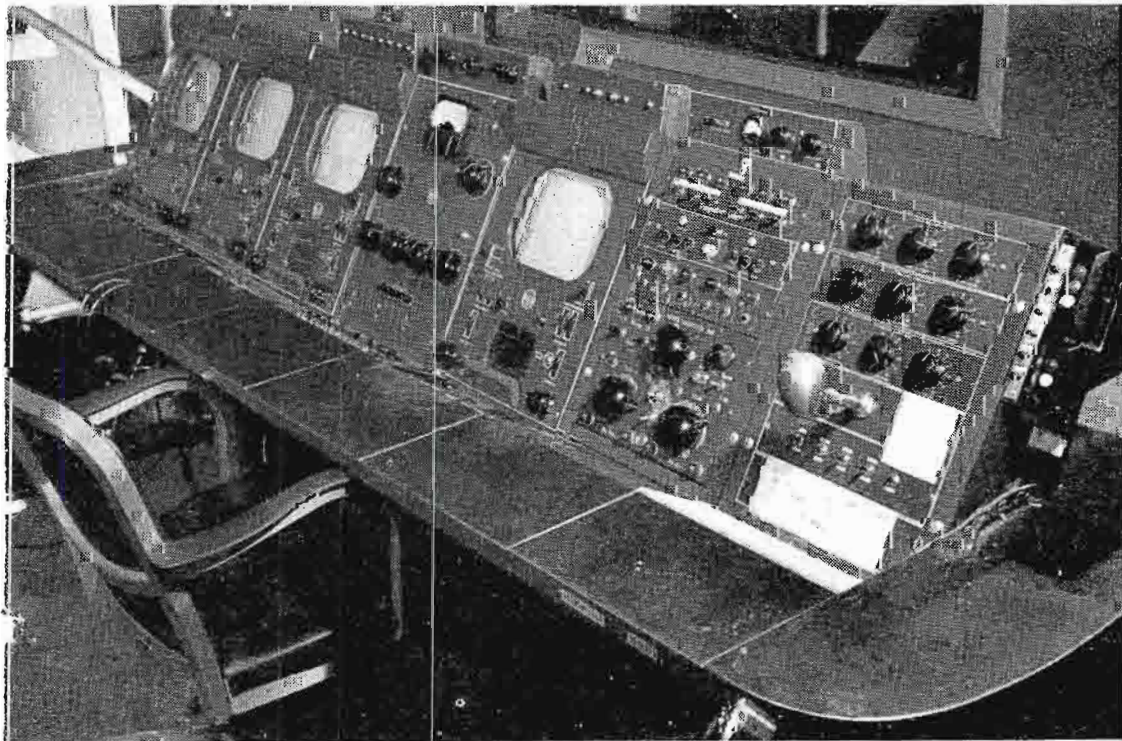

FIG. 19. TV master control console. Units from left to right: two studio camera controls, line monitor, TC-4 master control switcher, TK-20D film camera control, projector remote control panels, stabilizing amplifier remote control panels. Top left is door to Subcontrol A.

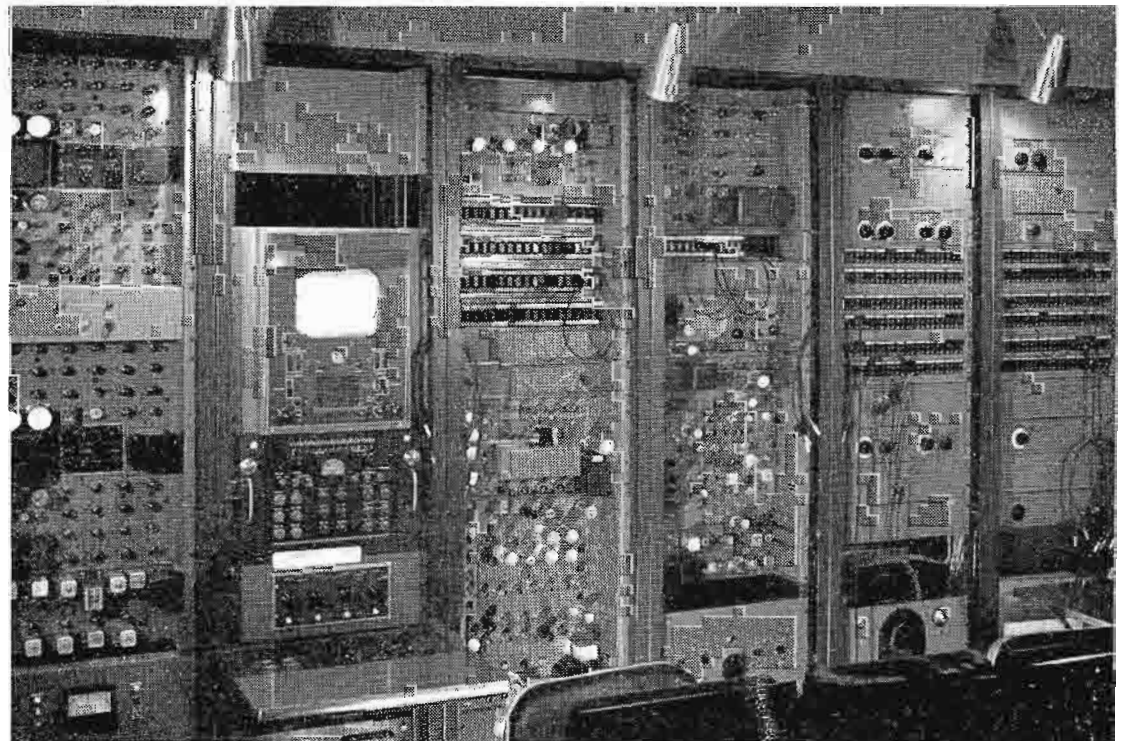

FIG. 20. Master control racks (console in foreground). Racks left to right, TG-2 sync generators, TK-26 3-V control, video jacks and effects equipment, colorplexer and color bar generator, two audio racks. At extreme right one of two field camera controls for Studio D cameras.

Studio D (Fig. 21) is a theatre-type auditorium with permanent seating for over 150 guests. Telecasting is performed on a stage at one end of the studio. As in Studio A, this auditorium has radio-studio acoustics. Inasmuch as stage border lights were already installed, converting Studio D into a TV studio was a simple matter of installing two additional light battens at the front of the stage and erecting camera ramps from the stage into the auditorium.

The film department is located on the first floor of the building in order to expedite receiving and shipping film. All film handling, editing and storage is performed in the film room which is shared with the photographic department. This latter department has darkroom facilities for making slides, opaques, publicity stills, and 16 mm motion pictures. In a competitive market such as Indianapolis, it is necessary to broadcast ample coverage of local news events with silent and sound on film.

Patch-Panel Power

In order to provide maximum flexibility in the WISH-TV studio and transmitter plants, all wiring between power supplies and equipment is interconnected through barrier-type terminal strips and power-supply patch panels. Two sets of barrier terminals intercept each circuit, one in the power-supply rack, and the other in the load-equipment rack. Each power supply terminates on a "Jones" receptacle on one of the three power-supply patch panels; one panel is used for each type of supply, i.e., WP-15, WP-33, and 580-D. Figure 13 shows the relation of the panels to the power supplies in the racks. Figure 22 is a close-up of the 580-D panel. Each receptacle in the bottom row marked "Power" is connected to a 580-D supply; nine of these are in regular use, and the tenth is a spare. There is likewise one spare WP-15 and one spare WP-33 on each of the other panels. In all panels, the spare was located in the middle of the row to keep the length of the "patch-cords" to a minimum.

The upper row of receptacles shown in Fig. 22 are each connected to an amplifier or group normally fed by a 580-D. Each normal supply is connected to its normal load by the "patch-cord." Deep-bracket receptacles and plugs were used to prevent accidental removal. The pins on the power-supply receptacles are male, and on the load female to prevent hazard of shock or accidental grounding while patching. Primary AC is wired through the receptacles to each power supply in order that the supply can be energized immediately.



FIG. 21. Auditorium (Studio D) as seen from lobby.

A spare power supply may be put in service in a matter of seconds with this system and the patch-panels have literally paid for themselves many times over.

Simplifying Maintenance

The barrier terminals were integrated in the system to permit easy reassignment of equipment when required by changes in the system or relocation of equipment in

the racks. In addition to this feature, we find them advantageous as test points when trouble shooting. The presence, or absence, of voltage at a barrier terminal immediately determines if trouble is in the amplifier or in the power supply.

The barrier terminals shown in Fig. 23 are in a power-supply rack; similar terminals are in the equipment racks. The left side of the terminals are interconnect-

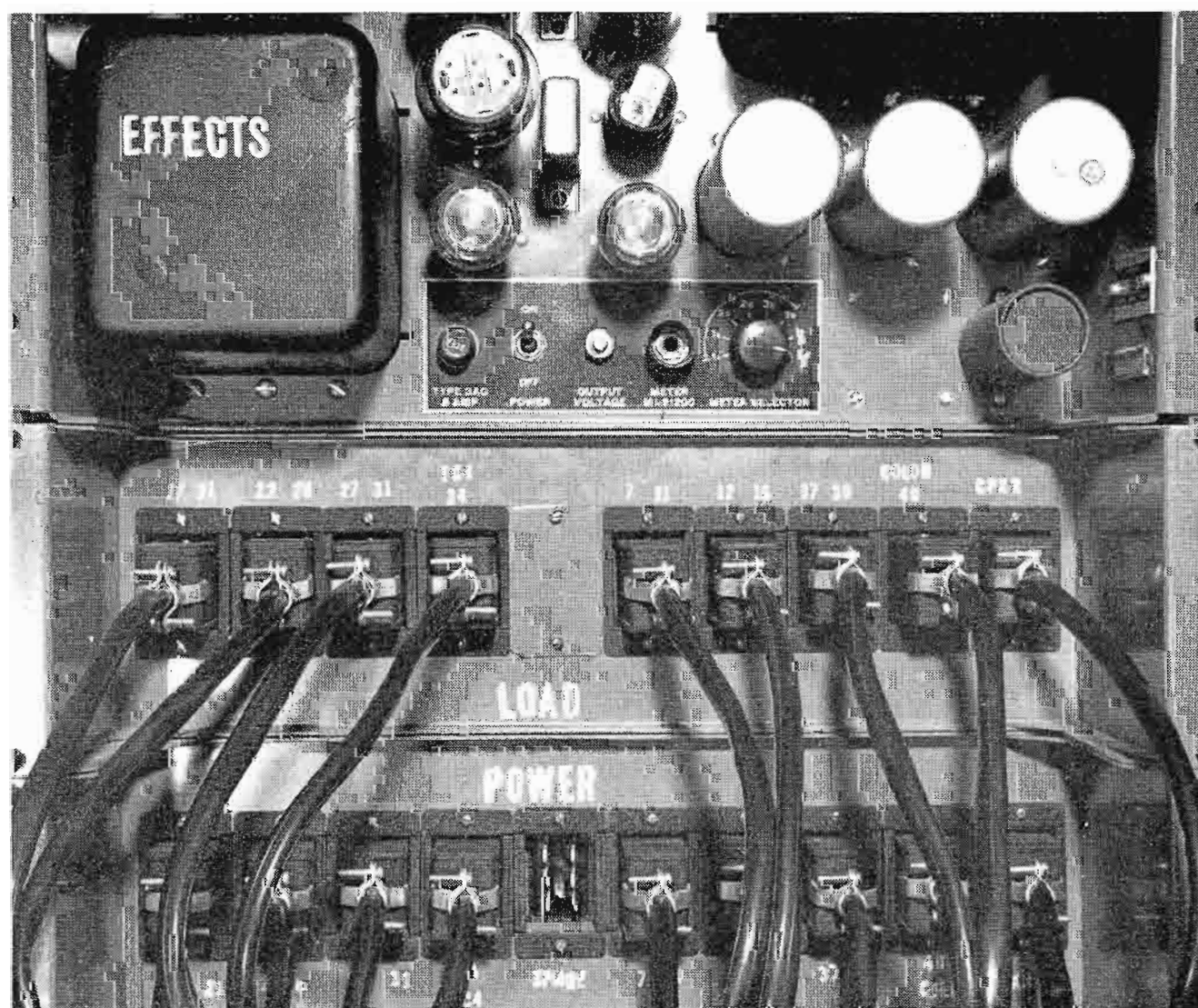

FIG. 22. Closeup of 580-D power-supply patch panel. Load receptacles at top and power supply receptacles at bottom. Spare power supply receptacle in center of bottom row.

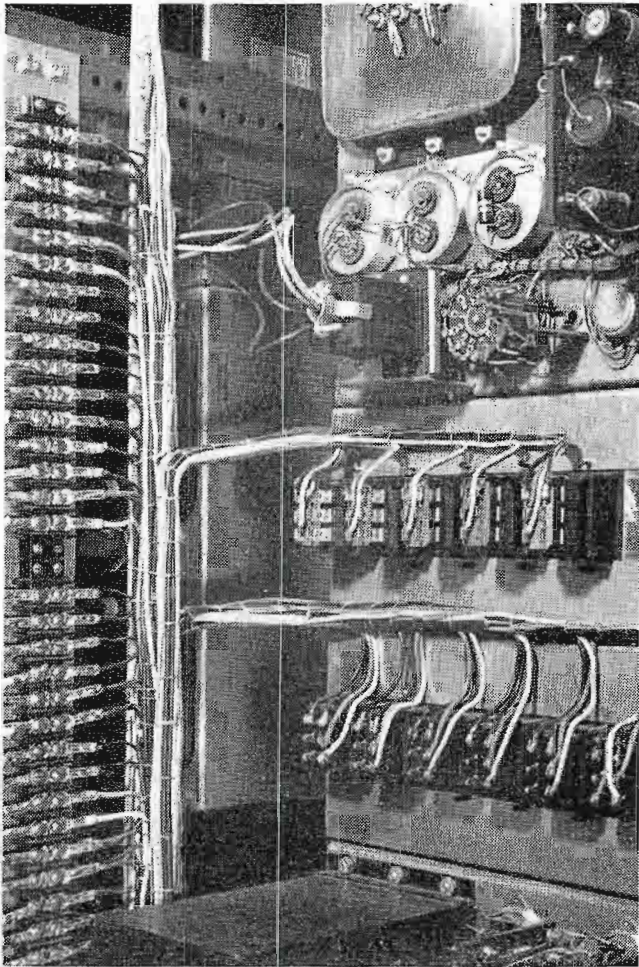

FIG. 23. Rear view of power-supply rack showing barrier terminals at left, and back of 580-D patch panels at right.

ing cables going to equipment elsewhere in the plant; the right side terminals connect to the intra-rack equipment, in this illustration, power supplies. This rack was chosen for illustration because it also shows the wiring of the 580-D patch panel, the front of which is shown in Fig. 22.

The drawing (Fig. 24) shows a typical circuit from power supply to equipment—a WP-33 Power Supply which normally feeds TA-5D Stabilizing Amplifier No. 6 with a remote-control position at the master control desk. All wiring in the WISH-TV plant is color-coded which further assists in isolating circuits. The drawing further illustrates the manner of handling centering voltage which is supplied by a WP-33, however not used with a load as shown: a strap is inserted on the load receptacle that grounds the centering voltage. On equipment requiring centering voltage (master monitors or cameras) no strap is

used. This method of wiring permits the use of any power supply for any load of comparable capacity. This jumper strap performs the same function as the jumper across C-3 in the WP-33 power supply.

Conclusion

We have now considered in some detail our combined operation of radio and television, which we have found to be very satisfactory and, indeed, quite advantageous. Good design practices, coupled with adequate attention to possible problems, have eliminated common sources of trouble before they started. Innovations and modifications of ordinary practices have resulted in efficient operation and fast maintenance. Our idea of "centralized control" has proved to provide the kind of flexibility that defeats obsolescence. It has paid off in enabling us to add color facilities without either decreasing our efficiency or exhausting our potentialities for expansion.

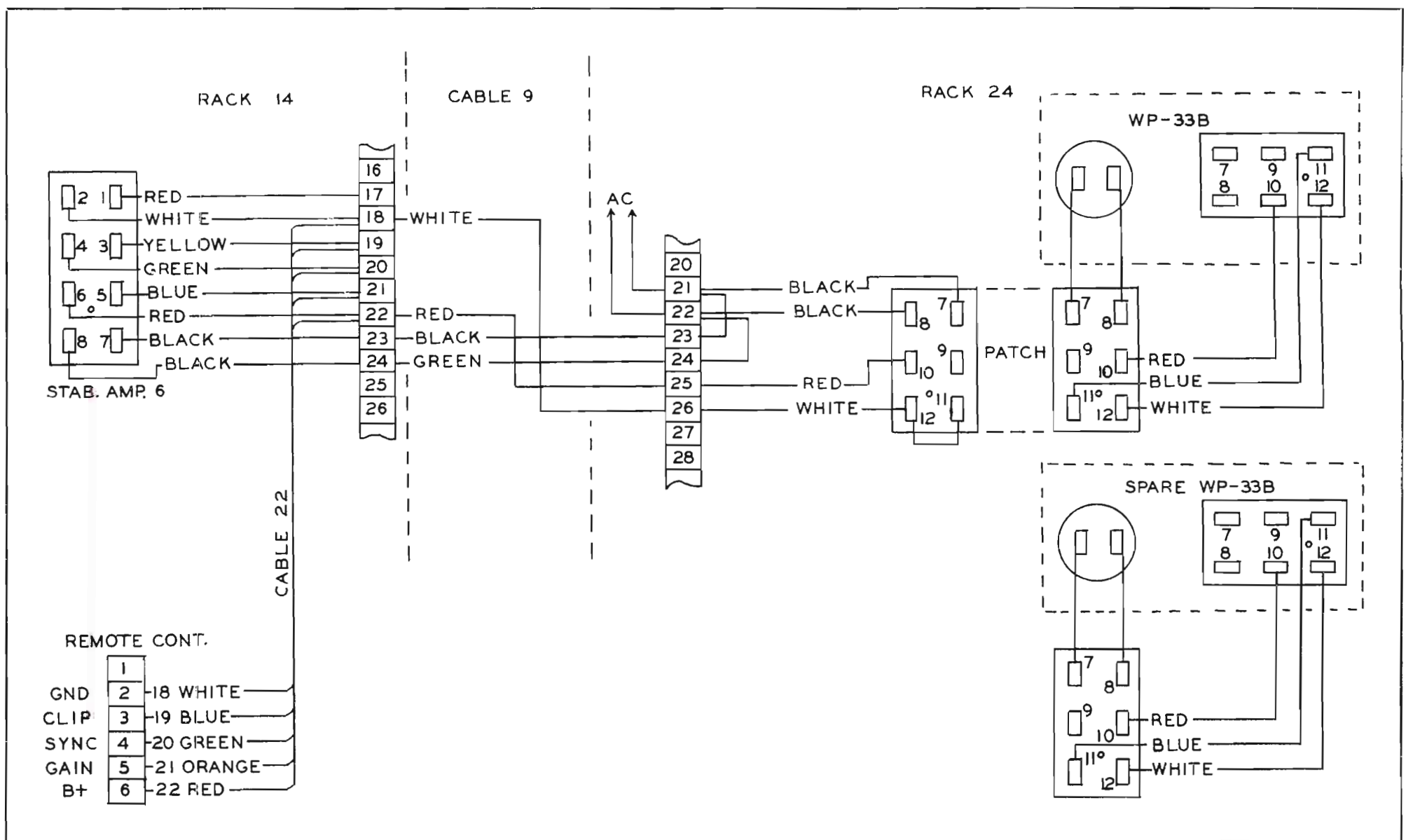

FIG. 24. Wiring diagram of power-supply patch system.

TRAVELING WAVE ANTENNA

New TV Antenna for VHF High Band Provides Improved Pattern Characteristics, High Power Handling Capacity, Improved Input VSWR, Less Wind Load, and Simplified, More Economical Installation

by MATTI S. SIUKOLA and GEORGE A. KUMPF, RCA Broadcast and Television Engineering

The superturnstile antenna has been the basic antenna of the television broadcast industry for some ten years, however the trend toward higher power and higher gain has introduced increasing complexity which could only be satisfactorily solved by an altogether new approach. Therefore a research program was undertaken to develop an antenna which would permit simplicity in its mechanical construction and feed system, in addition to being capable of ideal radiation characteristics for low, medium and high-gain usage at power levels required in the foreseeable future. This led to the development of the Traveling Wave Antenna, which should be immediately attractive in the trend toward high gain.

The maximum economy of operation of the television transmitter plant for a prescribed ERP is obtained by taking advantage of high antenna gains. In the VHF range this is especially important for channels 7 through 13, where over three times as much ERP is permitted as on channels 2 through 6, and where the plant becomes more expensive to build and to operate. First costs as well as operating costs are reduced to a minimum by this new approach.

Early experience with even moderately high-gain antennas was unsatisfactory because the uniform current distribution used resulted in field intensity patterns having deep nulls in parts of the service area. This effect was overcome by adjusting the current distribution along the antenna, producing a contoured vertical pattern. The best current distribution obtainable, however, fell considerably short of ideal, because the variation was limited by the number of radiators along the length of the antenna. Furthermore, as the gain was increased the feed system grew more and more complicated. This increased the cost of the antenna, and at the same time the large diameter of the pole and feed system had an effect on the horizontal circularity of the pattern. To overcome these problems and to obtain high values of gain when needed, RCA has developed the Traveling Wave Antenna for channels 7 to 13.

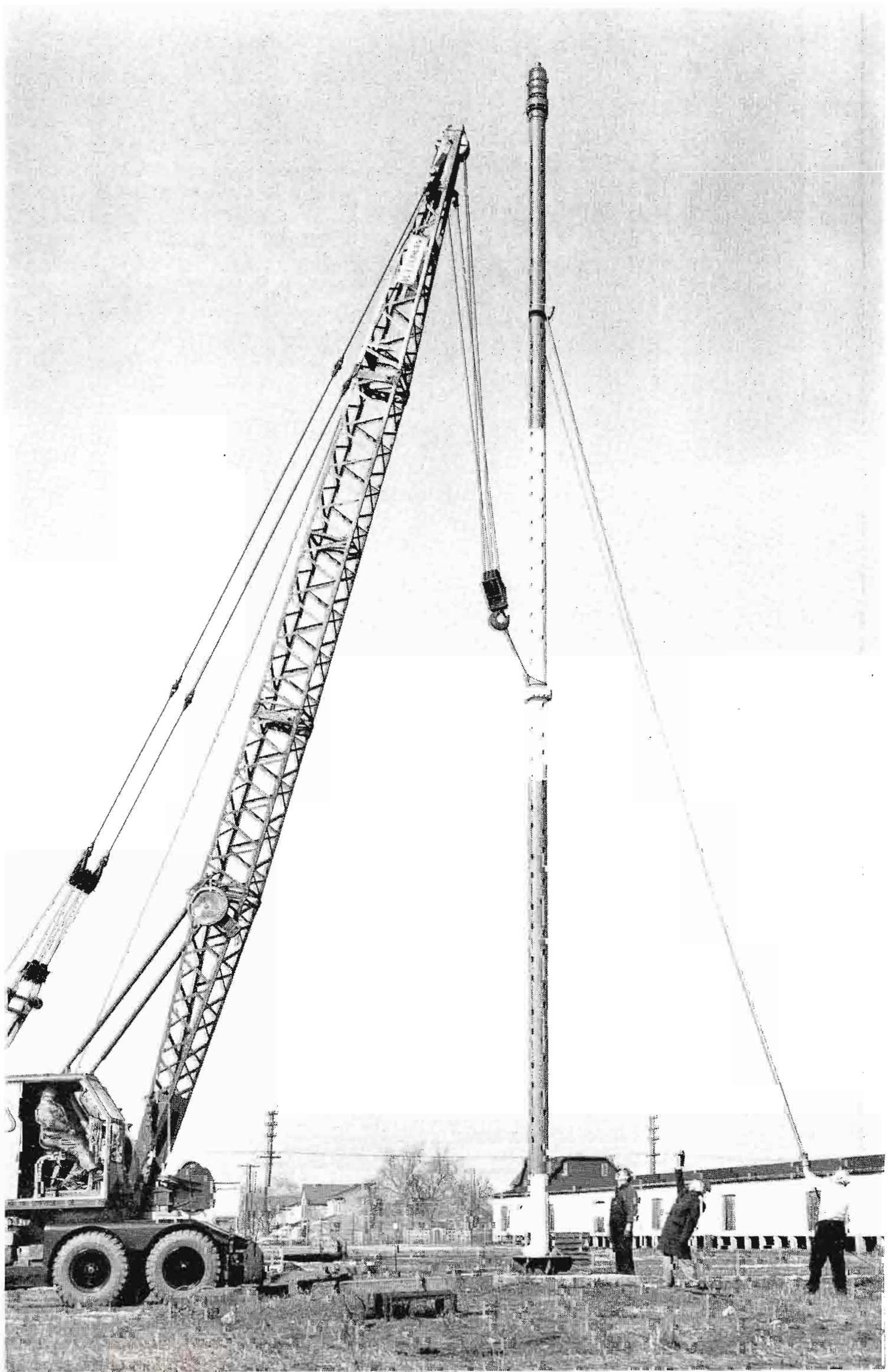

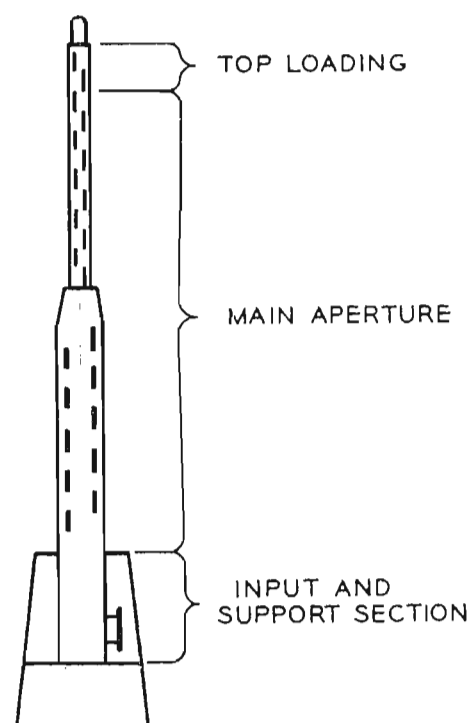

FIG. 1. Outline of the Traveling Wave Antenna.

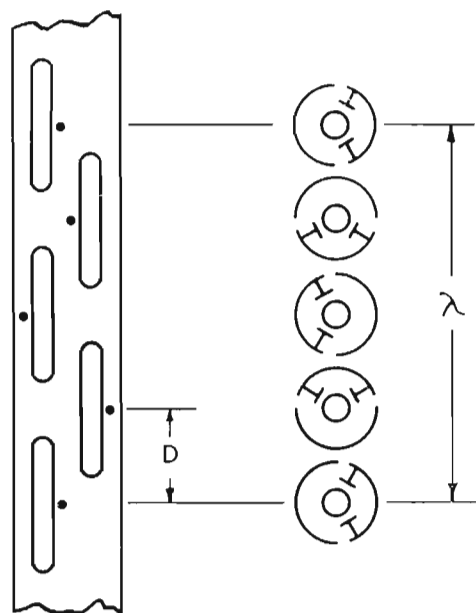

FIG. 2. Simplified drawing shows a portion of the main aperture and its cross-sections at the center of each slot pair. The successive slot pairs are spaced electrically a quarter wavelength apart (D), and they are alternately in two perpendicular vertical planes. Location of the coupling capacitors provides correct phasing resulting in omnidirectional operation.

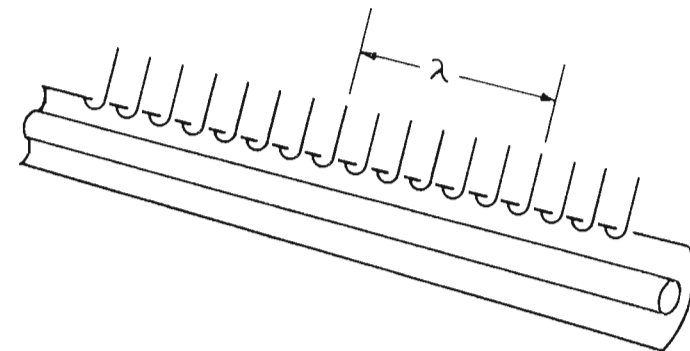

FIG. 3. Hypothetical starting point of the evolution of the antenna. A row of evenly spaced short radiators load the coaxial line to approximate uniform loading and maintain the traveling wave nature of the signal as well as a low VSWR within the line.

Description

The Traveling Wave Antenna utilizes slot radiators in the form of a tube with longitudinal slots cut around the periphery. In its simplest form the antenna consists of three parts: input and supporting section, main aperture, and top loading (see Fig. 1).

The antenna has been designed for tower mounting. Thus part of the pole is buried in the tower. Besides providing support, this buried section also forms a coaxial transmission line leading into the radiating portion of the antenna. Power is fed into the line near the bottom end by a tee section to facilitate good rigid mechanical support for the inner conductor of the antenna.

The main aperture follows the principle shown in Fig. 2. The pole itself forms a coaxial transmission line for the antenna. There is a pair of slots every quarter wavelength (D) along the pole. Every other pair is in one vertical plane, and the remaining pairs in another vertical plane perpendicular to this. In each pair the opposite slots are coupled in the coaxial line in opposite phase, and in each row the side of the coupling capacitor or probe alternates to excite all slots in phase. All slots are alike and all probes the same size. This arrangement can be visualized to operate as a turnstile antenna.

At the top of the antenna the inner conductor is short-circuited to the outer conductor. This is done by a sliding contact to allow for differential expansion between

the pole and the inner conductor due to temperature variations. The last two pairs of slots differ in characteristics and also in dimensions from the other slots and similarly the coupling networks are different. These two slot pairs including coupling networks and the short are called the top loading.

Development

The primary objective was to develop a VHF high-channel antenna for omnidirectional service, which would have excellent performance at low cost especially at medium and high-gain values.

For broadband high-gain antennas it is customary to excite separate radiators, or at least small groups of radiators through feed lines of equal length to maintain radiating current phases equal enough to have essentially the same radiation pattern across the channel. This means that a number of feed lines are needed, and many of the lines are longer than would be mechanically necessary. This results in a

complex construction and affects the circularity of the radiated pattern.

In the Traveling Wave Antenna an extremely simple method of feed is employed. The supporting pole forms the outer conductor of a coaxial transmission line, and power is tapped off from the line at each radiator thus eliminating the need of any feed lines. Figure 3 shows the principle of the feed system using short rod radiators to illustrate the theory. A number of radiators per wavelength uniformly spaced are loosely coupled to a coaxial line. Because of the number of radiators and the relatively slight reflection due to each, the effect is essentially that of a uniform loading. The result is a uniformly attenuated traveling wave in the line. Since a traveling wave has a linear phase characteristic the excitation of each successive radiator will be lagging from the previous one by an amount which depends upon the spacing between the radiators and the velocity of propagation in the line. If the

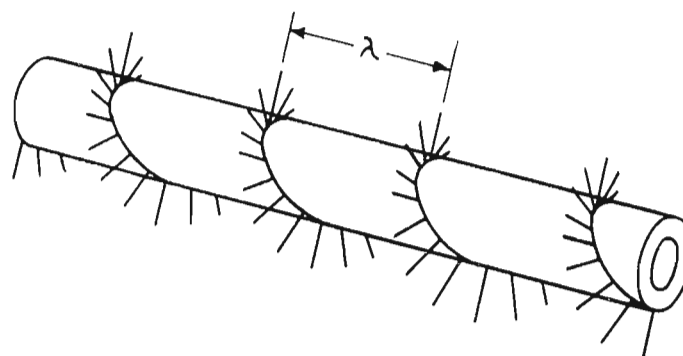

FIG. 4. Antenna having radiators located around the coaxial line on a spiral which has the pitch equal to the wavelength in the line. It has rotating radiator current phase around the periphery and provides an omnidirectional pattern with the main beam perpendicular to the axis of the array.

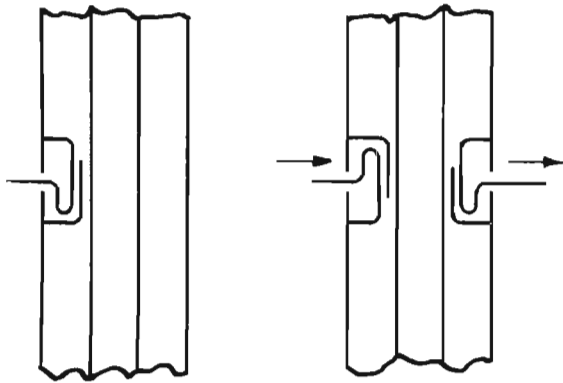

FIG. 5. For the elimination of undesired excitation of the pole the system can be changed from unsymmetrical (left) to symmetrical (right) by using radiators in pairs opposite to each other and in opposite phase. To maintain coupling as purely inductive as possible, the coupling loops are capacitively shielded.

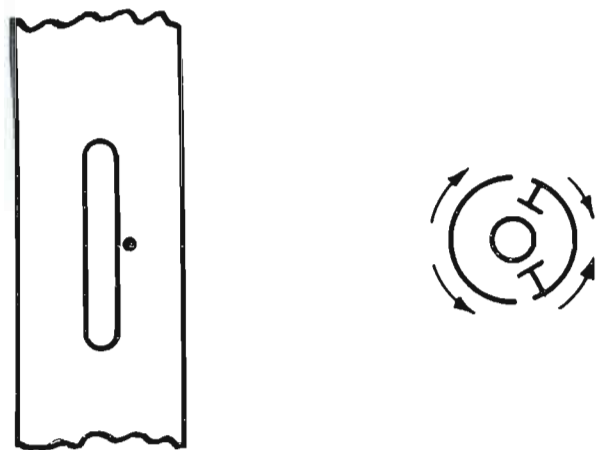

FIG. 6. Slots being used in pairs and fed in opposite phases to provide radiation similar to that of a dipole. The use of slots simplifies coupling network by allowing utilization of capacitive coupling, also eliminates protruding radiators and makes possible lesser wind load.

radiators are alike, their currents will have the same phase relationship as the excitation. Thus the radiating currents will be successively lagging, and repetition of phase occurs after every guide wavelength.

To obtain an omnidirectional pattern the radiators instead of being in line can be moved around the periphery to form a "spiral" as shown in Fig. 4. For a horizontal main beam the pitch of the spiral has to be equal to the guide wavelength in the transmission line. In this arrangement all of the radiators in any one vertical plane on one side are in phase, and the phase difference between radiators in different planes equals the azimuth angle difference between the planes, that is, the



FIG. 7. Final inductively tuned slots for a gain of 9 antenna on 10 $\frac{3}{4}$ inch diameter pole section being inspected by the authors, Matti S. Siukola (left) and George A. Kumpf.

phase rotates around the periphery. The rotating phase produces a rotating field which, because of the relatively small amount by which the magnitude of current changes from layer to layer, produces an omnidirectional pattern.

In practice, however, to insure proper operation two modifications have to be made. First, excitation has to be made symmetrical instead of asymmetrical in order to avoid undesired excitation of the pole itself (see Fig. 5). Second, mutual coupling between the radiating elements has to be minimized to maintain proper phase relationships. Both results can be accomplished by limiting the number of radiator pairs to four per turn of spiral. This modification reduces the antenna to two sets of center fed dipoles, the sets being confined to two perpendicular vertical planes fed in phase quadrature. The traveling wave nature of the signal in the line remains, however, since the relatively small reflections produced by the radiator pairs for the most part still cancel each other, though not because of uniform loading by radiator pairs but because of the approximately quarter wavelength spacing between them. We thus have, in essence, a traveling-wave-fed turnstile antenna.

To further improve the antenna, the dipoles can be replaced by slot pairs which are fed in opposite phases to produce a dipole type of radiating current (see Fig. 6). This reduces the wind loading by eliminating protruding radiators, simplifies the coupling circuit by allowing capacitive

coupling, and improves pattern by proper radiating-current distribution. The final basic form of a section of the Traveling Wave Antenna is thus as already shown in Fig. 2.

As mentioned previously for an antenna to provide a distortion-free television service, proper phase relationships between the radiators have to be maintained across the channel. This has been accomplished by a very unique design of the Traveling Wave Antenna. In a coaxial transmission line the velocity of propagation is normally constant and the wavelength in the line varies with the frequency. However, if loadings with proper characteristics are imposed on the line, the wavelength in the line can be made constant within a certain bandwidth. This has been done in the Traveling Wave Antenna by making the characteristics of the slots such as to maintain a constant wavelength in the line across the channel in question, thus insuring proper phase of the slots. The desired characteristics for the slots have been obtained by determining proper length and shape for them (see Figs. 7 and 8).

In addition to the slots and the coupling capacitors (C_m in Fig. 9) each layer in the main aperture also contains another pair of capacitors (C_A) provided for beam tilting and fine tuning of the velocity in the antenna during development. To provide for some tuning of frequency either inductive change at the ends of the slots or capacitive loading in the middle of the slots can be used (see Figs. 7 and 8).

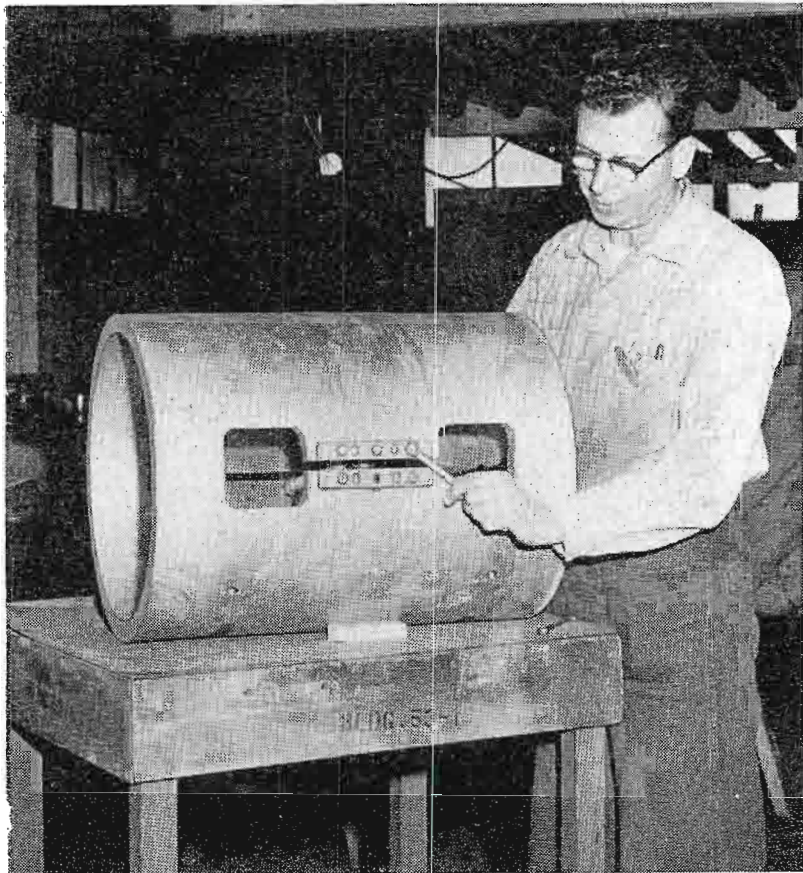
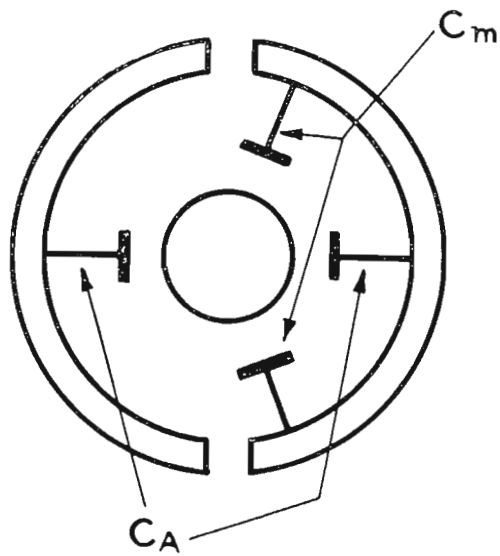

FIG. 8. An experimental short section of 18 inch diameter pole having a pair of capacitively tuned slots for a high gain Traveling Wave Antenna.

$C_m =$ COUPLING CAPACITORS



(A)

EQUIVALENT
CIRCUIT

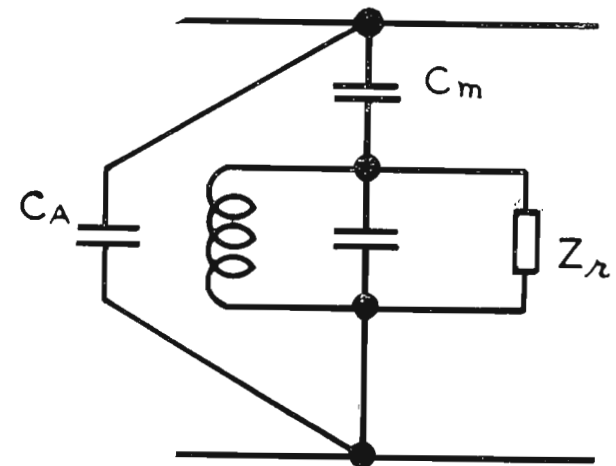

$Z_r =$ RADIATION IMPEDANCE

(B)

FIG. 9. Sketch on left (A) shows the location of the phase correction and beam tilting capacitors (C_A), and sketch on right (B) gives an equivalent circuit presentation of one slot pair.

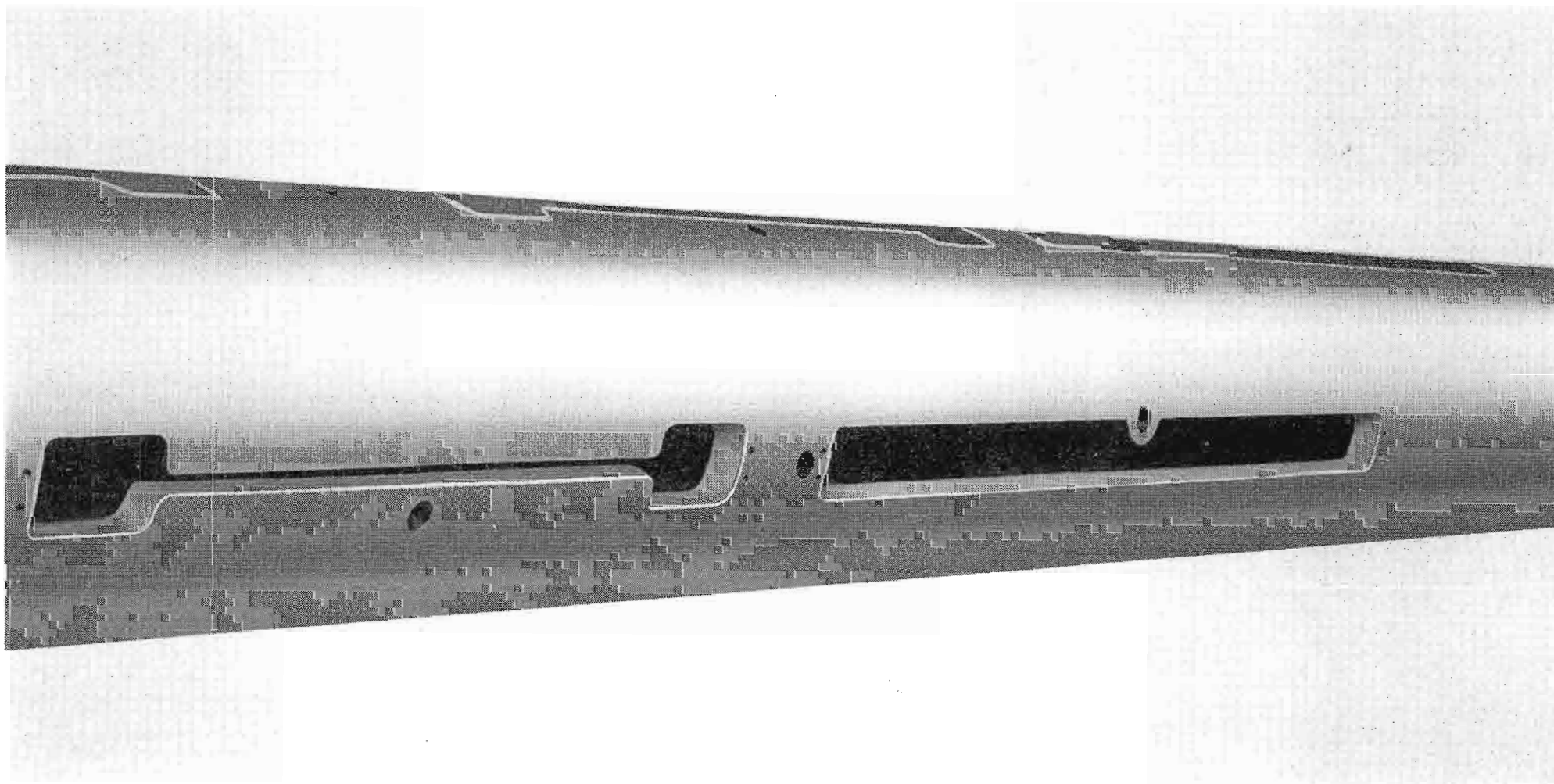

In the main aperture, each slot pair successively extracts a portion of the energy from the traveling wave, and when the signal reaches the top of the antenna, all but a few per cent of the energy has been extracted and radiated. The remaining energy is radiated by the top loading. Besides contributing to the radiation, the top loading also provides a proper termina-

tion for the main aperture. This operation has been achieved by proper characteristics of the slots and the coupling networks in the top loading (see Fig. 10).

As shown in Fig. 1, the power is fed into the antenna through the tee at the bottom end of the pole. To provide a broadband low-reflection input, the bottom end of the pole forms a quarter wavelength shorted

FIG. 10. Difference between the slots in the main aperture (left) and the much longer slots used in the top loading to provide proper type of loading in each case.

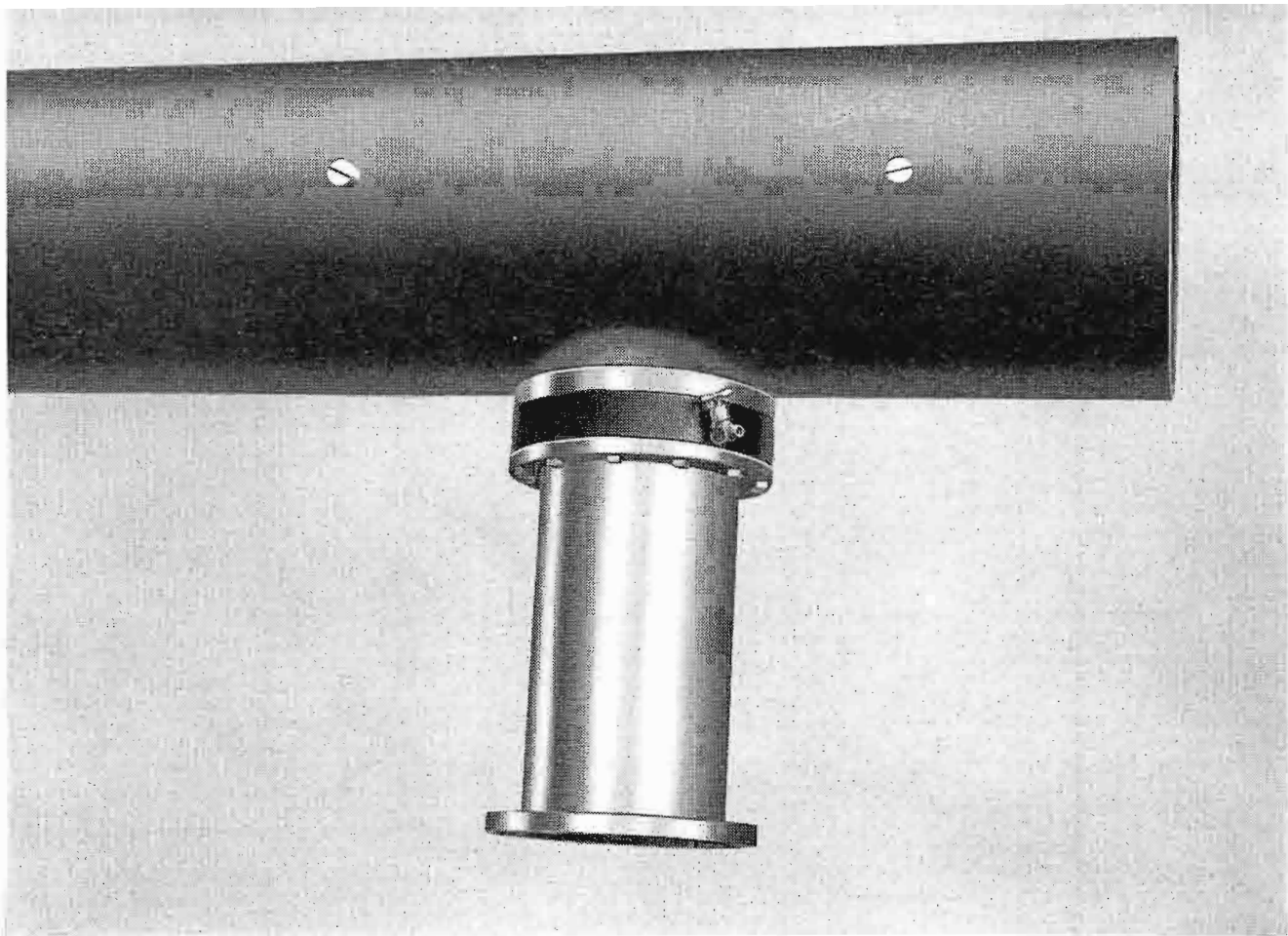

FIG. 11. Input tee of a Traveling Wave Antenna showing the location of gas stop right next to the pole. The antenna is not pressurized, but drainage holes are provided to take care of any condensation within the pole.

stub and the inner conductor on each side is equipped with compensating transformers. In addition, great care has been taken to maintain proper characteristic impedance in the tee joint itself (see Figs. 11 and 12).

Characteristics

Several important design features were aimed at and accomplished in the new Traveling Wave Antenna as can be seen from the following excellent performance characteristics:

1. Improved circularity of the horizontal pattern:

The achievement of good pattern circularity for previous higher gain antennas

has been a major obstacle at high VHF channels. There are two main reasons for this. First, the pattern produced by the radiators themselves may deteriorate because of the change of shape or location needed for mechanical reasons. Second, the radiation is often affected by large supporting structures or feed systems necessary for high-gain, high-power antennas.

In the Traveling Wave Antenna, by using slot radiators in pairs, with successive pairs in space and phase quadrature, a radiating-current distribution has been obtained so that even for large pole diameters a circular pattern has been inherently produced. In addition, there are no interfering external elements in the field. The

antenna combines radiating elements, feed system, and the supporting structure in one unit, giving excellent horizontal circularity. Representative measurements made at channel 10 by using an 18-inch diameter 30-foot long antenna section, which corresponds to the lower sections of an antenna for a gain of approximately 18, gave a circularity of ± 0.7 db (see Fig. 13). At present the Traveling Wave Antenna is made only for omnidirectional service.

2. Improved vertical pattern without substantial loss of gain or simplicity of the antenna:

Most broadcasters prefer a vertical pattern which provides a uniformly high field strength over the service area. This type of pattern can be obtained by changing the amplitude and/or phase distribution of the radiating currents along the aperture of the antenna. To achieve such a pattern, and still maintain a high gain per wavelength of aperture, often requires extensive variations in both amplitude and phase for a large part of the aperture. These non-uniform distributions tend to make the antenna complicated and expensive.

In the simplest form of the Traveling Wave Antenna, when all the slots are alike and coupling capacitors are of the same size, the attenuated traveling wave in the transmission line and the illumination of the aperture decrease exponentially (see Fig. 14). To take full advantage of the excellent pattern characteristics of this principle, the antenna would have to be tall enough for the energy in the line to diminish to a very low value. However, the antenna

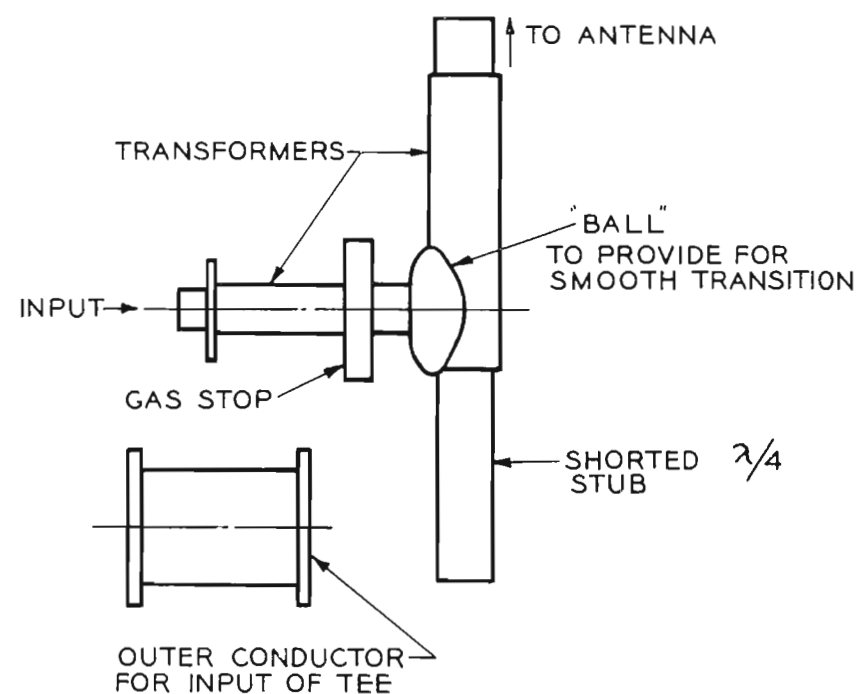
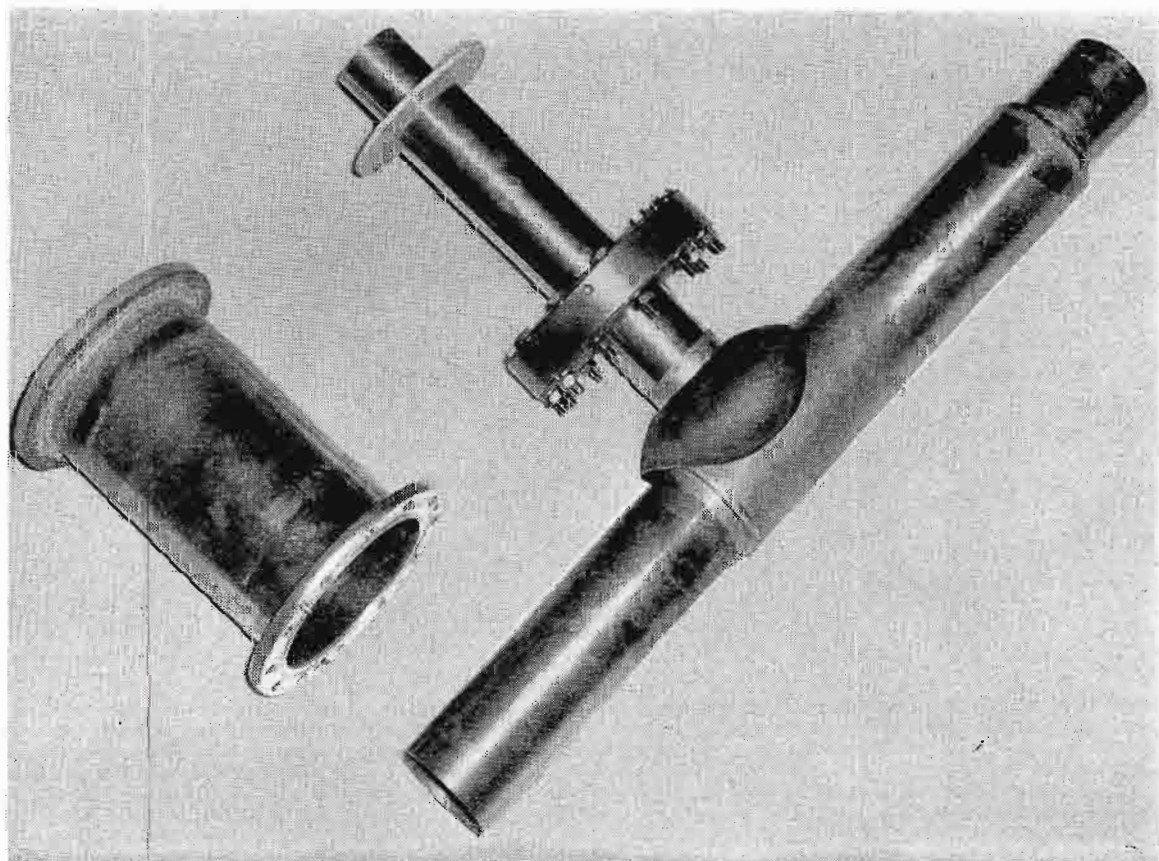

FIG. 12. Inner conductor of the input tee with transformers, stub and gas stop identified. Of special interest is the "ball" at the junction to maintain the desired characteristic impedance.

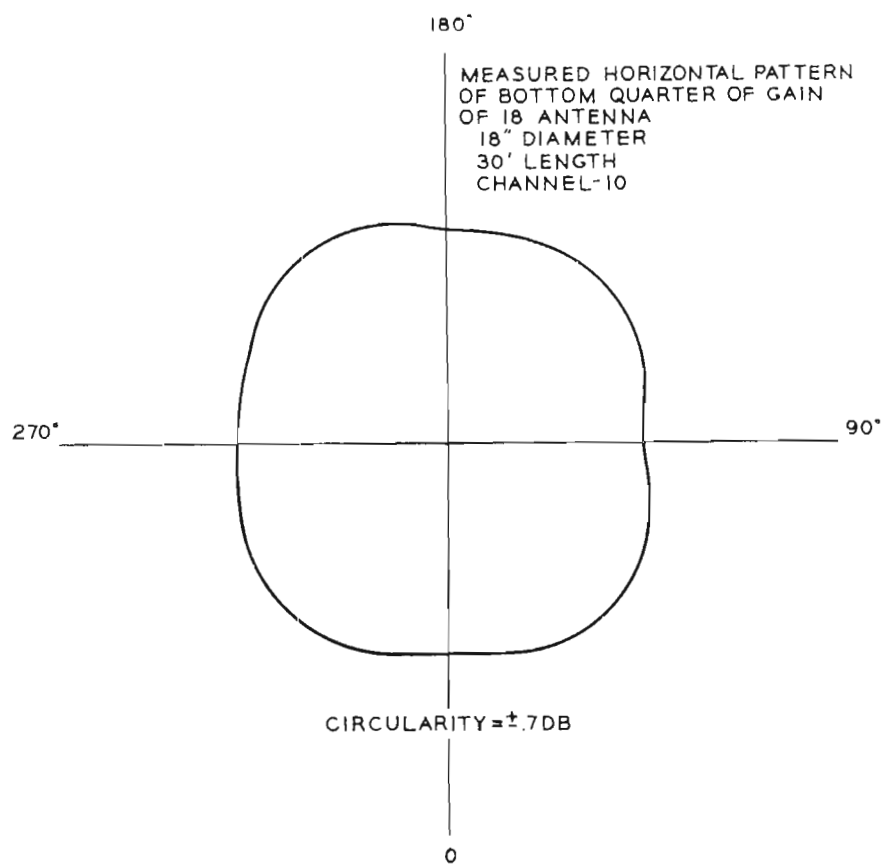

FIG. 13. Measured horizontal pattern of a large diameter (18") 30 foot long section (bottom quarter) of a gain of 18 Traveling Wave Antenna.

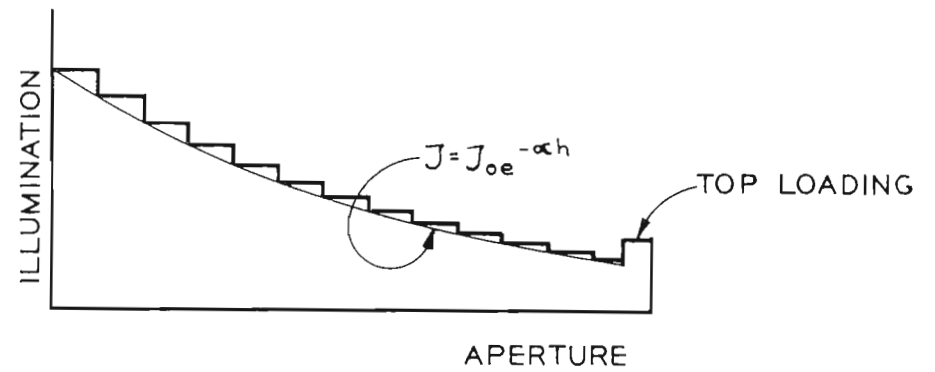

FIG. 14. Magnitude of illumination of the Traveling Wave Antenna. Uniform coupling along the main aperture produces the exponentially decaying portion, and the top loading forms the hump at the end by radiating the remaining power.

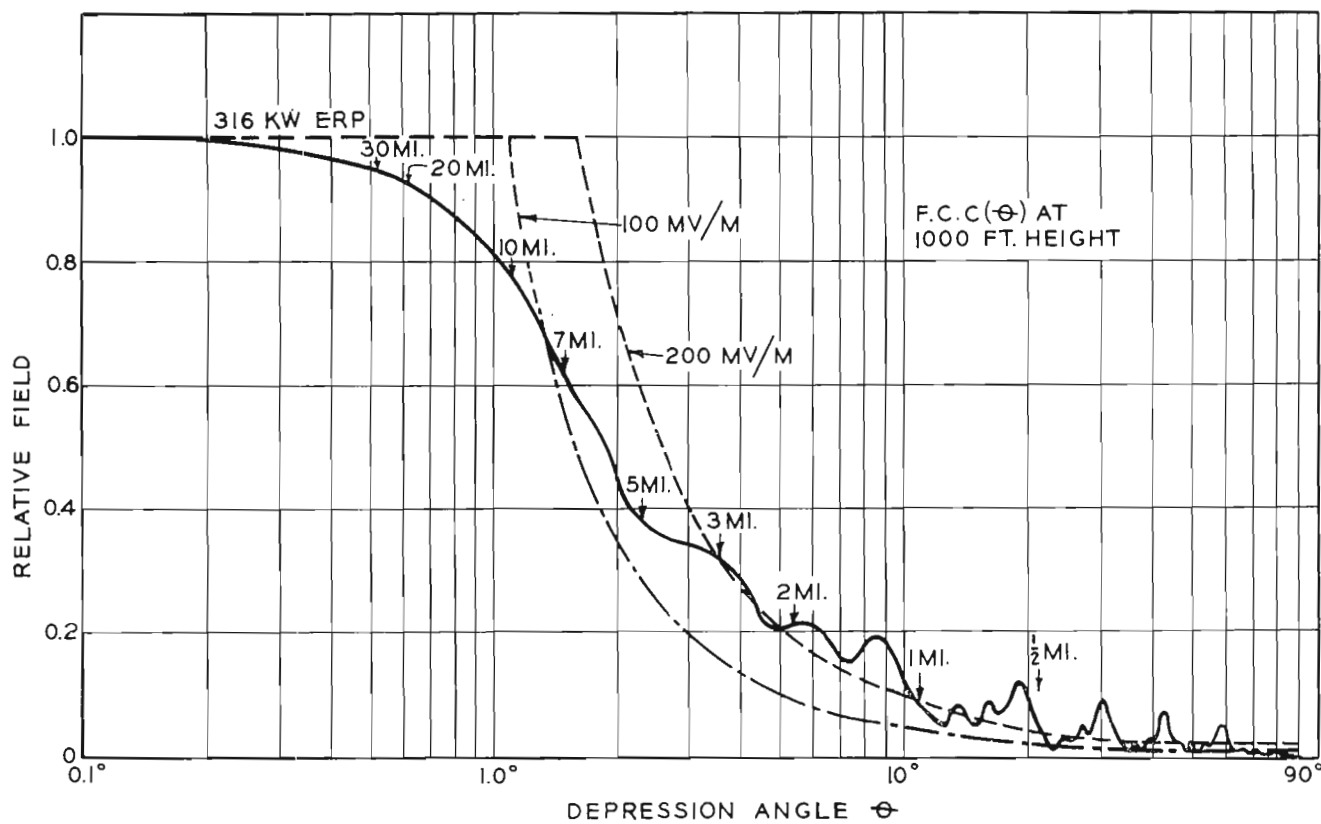

FIG. 15. A calculated example showing the inherently good vertical pattern produced by exponential amplitude and zero phase distribution of illumination of a gain of 18 Traveling Wave Antenna.

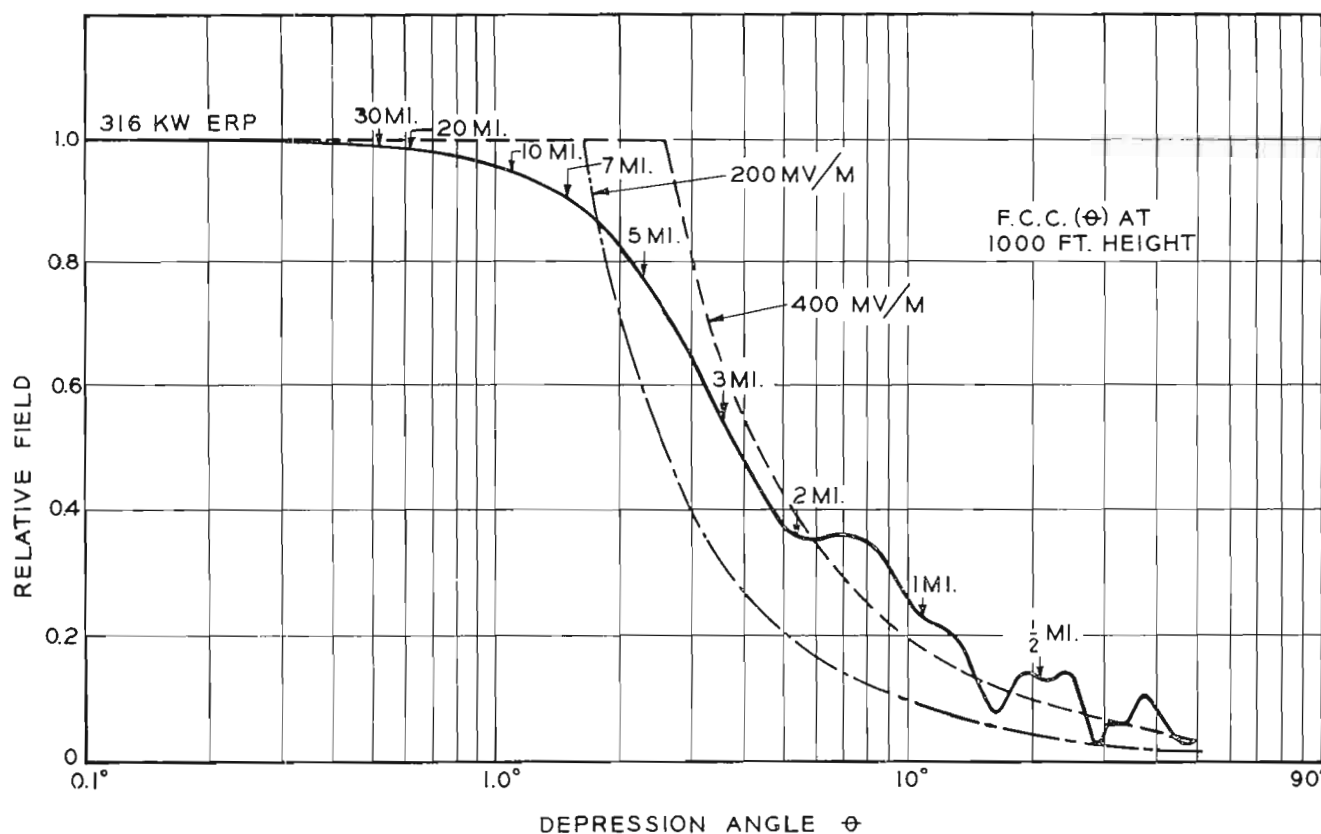

FIG. 16. Calculated vertical pattern of a gain of 8 Traveling Wave Antenna.

can, for the same value of gain, be shortened, up to one third, without any appreciable deterioration of the performance. This is accomplished by the top loading, which collects and radiates all of the remaining power, producing an increase of illumination at the top end of the antenna. If no beam tilt is employed, the relative phase along the whole aperture is zero. Because an exponential distribution of illumination with linear phase produces an extremely smooth, null-less pattern, then even by cutting the infinite antenna to a finite length, by employing the top loading, and by leaving the slots off at proper places to accommodate the flange joints, a vertical pattern is obtained which still is almost ideal. It provides the service area at most locations with a uniformly high field strength (see Figs. 15 and 16). These patterns are calculated, but representative measurements have substantiated the validity of the calculations. Beam tilt can be easily incorporated into the design if desired.

3. *Low VSWR and input impedance:*

The traveling wave nature of the feed already reveals that a low VSWR exists all along the antenna except for the top loading. This characteristic, inherently gives the antenna a good input VSWR without any compensating or matching devices. Further improvement is obtained by adjusting the input slot pair to half the loading of the others. The input tee has been broadbanded to provide a smooth transition from the transmission line to the antenna. Measurements made on a representative section of a gain of 20 channel-10 antenna showed the VSWR to be equal to or less than 1.036 to 1 across the channel. At lower gains it is slightly higher.

At present, antennas are being made for 50-ohm input impedance.

4. *High power handling capacity:*

With the trend toward increases in allowable and desired ERP, an antenna should have not only adequate power handling capacity but preferably more than needed to allow for future increases of ERP. For mechanical reasons, the transmission line in the Traveling Wave Antenna has a very high power-handling capacity. Since there are no feed lines, the maximum power is limited by voltage gradients in the components, the capacitors, the slots and the input section. All of these have very little effect on the other characteristics of the antenna and therefore have been designed for any practical power-handling capacity needed in the near future.

5. *Aperture efficiency and gain:*

The maximum theoretical gain per wavelength that can be obtained for an omnidirectional antenna which is uniformly illuminated is 1.22 per wavelength of aperture. Such an antenna would have zero nulls over its entire vertical pattern. Furthermore, because of mechanical dissymmetries in any practical design, the ideal can never be fully achieved. Based on accurate measurements, most practical antennas have gains between 0.8 to 1.0 per wavelength of aperture depending upon the amount of null fill used. In the simplest form of the Traveling Wave Antenna, as discussed herein, the antenna has a power gain of about 0.9 per wavelength of aperture. This gain is about as high as can be expected for the type of null-less radiation pattern in question. At present, gains from approximately 6 to 20, at VHF high band can be achieved.

6. *Simplicity of feed system and radiators:*

In most of the conventional high-gain

antennas, power is distributed to the radiators from the central transmission line through feed lines. The size of the feed lines is normally determined by the power capacity required, and if properly rated they perform their function satisfactorily. However, for high-gain, high-power antennas for channels 7 to 13 the number of the feed system components increases. This increases the chance of component failure. Furthermore, as stated previously the size of the components in the field may affect the pattern.

In the Traveling Wave Antenna, the feed system is completely inside the antenna, and therefore, any effects on the pattern have been eliminated. In addition the feed system is very simple, formed by a large coaxial transmission line and coupling capacitors. All of the components are protected against weather, thus providing maximum reliability.

The radiators of television antennas normally have to possess broadband characteristics or to be compensated by proper additional networks to maintain a low input VSWR. Broadband radiators tend to greater size and thus increase the wind load. Networks again increase the complexity and cost of the antenna.

In the Traveling Wave Antenna the low input VSWR is inherently provided for. The radiators on the other hand maintain a constant wavelength in the transmission line, which also requires specific characteristics for them. These characteristics, however, are very close to the "natural" characteristics of simple radiators like slots. This results in a mechanically simpler and more economical antenna.

7. *Transmission line connection:*

At present the Traveling Wave Antennas are equipped with a single $6\frac{1}{8}$ -inch transmission line connection at the input tee. A notch diplexer or filterplexer is required.

8. *Low wind load and high structural strength:*

Wind load is an important consideration because it greatly affects the cost of the supporting structure. The smooth cylindrical shape of the antenna is ideal in this respect.

The antenna itself is designed to withstand wind pressures of 50 pounds per square foot on flats or $33\frac{1}{3}$ psf on cylindrical surfaces. It is rated for a wind velocity of 110 miles per hour (true extreme with no ice on the antenna). The steel outer conductor is made of rolled

steel pipe with weld-neck flanges full strength welded to each end for coupling to its mate. All stress calculations are certified by consulting engineers.

9. *Weather protection:*

Like all broadcast antennas exposed to the elements great care must be exercised to design for wind, snow, rain, ice, lightning, electrolysis, sun rays and sudden changes in temperature.

The steel outer conductor, after fabrication, is hot dip galvanized for both better conductivity and weather protection.

Slot covers are fastened to the pole over each slot. They are made of special polyethylene that is not affected by ultraviolet rays from the sun, nor embrittled from the cold. To take care of condensation inside the antenna provisions are made for drainage.

The materials used for component items are selected to insure no corrosion effects from electrolysis due to dissimilar metals or chemical action due to industrial areas.

Since slot radiators are used, it is highly improbable that lightning will damage the antenna. However, to protect the 300-mm code beacon at the top of the antenna, provision is made for lightning by installation of a lightning protector which also supports the beacon. The grounding of the inner conductor at each end of the antenna provides further protection for the transmission line and transmitter.

If ice is collected on the antenna it lowers the resonant frequency of the slots thus affecting the performance of the antenna, mainly at aural carrier. Therefore, in areas of heavy icing, sleet melters (optional item) are recommended to avoid excessive accumulation of ice.

10. *Mechanical details:*

The pole is designed with a buried section extending into the tower. A guide flange at the tower top guides the pole into the tower during erection and prevents the pole from swaying. The pole socket carries the dead weight of the antenna.

All welding is done by certified welders and all welds on the pole are subjected to X-ray examination in order to eliminate any bad welds.

The inner conductor of the antenna is rigidly supported at the bottom end without having to rely on any insulator type of support to carry the dead weight. The

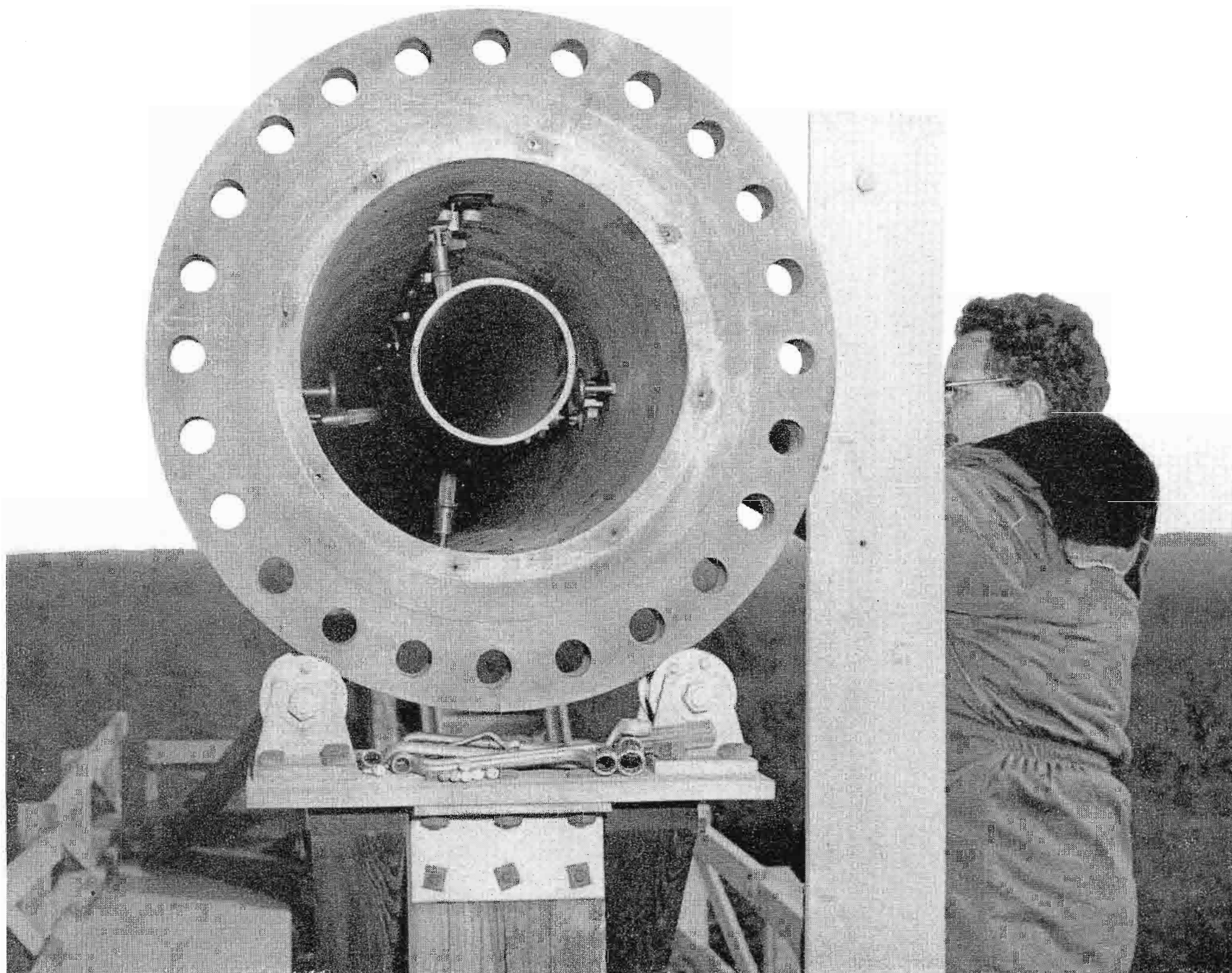

FIG. 17. End view of an 18 inch experimental section of the Traveling Wave Antenna showing the capacitors inside the pole supporting the inner conductor.

inner conductor can be removed from the bottom if required. The coupling capacitor probes besides being used for electrical coupling, also provide centering support for the inner conductor (see Fig. 17). This is accomplished by insulator pins which are built into the probes and form a portion of the dielectric of the coupling capacitors. The short at the top of the antenna has a sliding contact to allow for any thermal differential expansion between the inner conductor and the pole.

Conclusion

The Traveling Wave Antenna provides an answer for the need of a VHF high-band antenna which combines appreciable improvements of electrical characteristics with mechanical simplicity and economy, especially for high-gain, high-power uses.

The improved characteristics, most of them inherent to the principle, derive

from the unique combination of supporting structure, transmission line and radiators. The horizontal pattern is formed on the turnstile principle from the excellent patterns of single-slot pairs even at large pole diameters. The smooth vertical pattern, which helps to achieve an even field strength within the service area, is based on the exponentially decaying traveling-wave feed. The proper electrical characteristics of the simple slot radiators maintain constant wavelength instead of velocity in the transmission line for frequencies in the channel. This assures proper bandwidth. The low input VSWR is due to the traveling-wave nature of feed in the antenna. Simplicity of the antenna and low wind load result in economy of both the antenna and the supporting structure.

This new antenna is based on fundamental theory developed at the Ohio State University Research Foundation under contract between the RCA Victor Division and the Foundation.

NARTB'S ENGINEERING DEPARTMENT

Whenever you write to the Engineering Department of NARTB for some information you perhaps wonder who takes care of your letter. It is a small department with a total of three people. Here they are: the head of the Department is A. Prose Walker who has been with NARTB since July 1953, formerly with FCC for 13 years and before that a professor of math and physics. His assistant is George W. Bartlett who came with the Association in September 1955, formerly Chief Engineer of WDNC, Durham, N. C., for almost 10 years and prior to that a seagoing radio operator and FCC employee. The gal who takes all the dictation, types the letters and stencils, keeps the files straight and never forgets the thousand and one things that occur is Helene Burner.

Functions

The functions of the NARTB Engineering Department "cover the waterfront" on most aspects of both radio and television. Primarily, all NARTB activities relate to domestic problems of member stations. Occasionally, however, it is necessary that someone from the Association participate in international work such as the International Radio Consultative Committee (CCIR) which is an advisory body on technical matters to the International Telecommunications Union (ITU). Prose is the International Chairman of the CCIR Study Group X which is concerned with broadcasting. Preparation is now being made for the 1959 Ordinary Radio Conference (ORC) and the Department is participating in this work for the Department of State.

One day a week is usually spent attending meetings of the Washington Airspace Panel which recommends to the FCC whether or not a proposed tower, or height modification, is an unwarranted hazard to the aeronautical industry. NARTB is an associate member of the Panel and represents the broadcasting industry on an overall basis without presenting the specific cases of various broadcasting applicants. Both legal and technical information are provided the Panel whenever it is re-

quested. Also related to Airspace matters is the Joint Industry-Government Tall Structures Committee (JIGTSC) which was established to review the current criteria applicable to broadcast towers (Part 17 of FCC Rules) and make recommendations concerning any revisions required. NARTB was appointed to this Committee by FCC. Another study in which the NARTB Engineering Department has assisted is the new proposed marking and lighting specifications. These proposals are now in a period of being field tested before they are recommended to the FCC for changes in existing requirements. Other committees in which the Engineering Department participates are the Radio Propagation Advisory Committee (RPAC), Television Allocations Study Organization (TASO), IRE committee on Audio Recording Characteristics, Z-57, the AIEE Television-Aural Broadcasting Committee, etc.

Committees

There are two standing committees of NARTB pertaining to the work of the Department; the Engineering Advisory Committee under the Chairmanship of Raymond F. Guy, NBC, and the Engineering Conference Committee headed this year by John G. Leitch, Vice-President in charge of Engineering, WCAU. These groups function on over-all matters relating to the industry and in preparation for the annual Engineering Conference held concurrently with the NARTB Convention, which this year will be held at the Conrad Hilton Hotel, Chicago, April 7-11. Other committees are established from time to time which require participation by the Engineering Department.

On behalf of the entire industry, the Department is constantly working toward a simplification of time-worn rules and regulations of the FCC which need updating in consonance with the state of the art. The work in the field of remote control of transmitters is a step in this direction. Participation is required in many Rule Making proceedings of the FCC which relate to broadcasting, such as the Harmonic and Spurious Radiation docket proposed by the FCC, proposed rules hav-

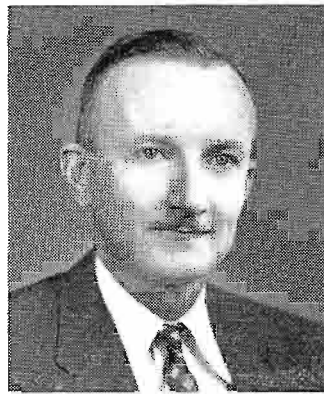

FIG. 2. George W. Bartlett, Assistant Manager of Engineering, NARTB.



FIG. 1. A. Prose Walker, Manager of Engineering, NARTB.



FIG. 3. Helene Burner, Secretary, Engineering Department, NARTB.

ing an impact on the use of wireless microphones, the current reallocation above 890 Mcs. proceeding and others of a similar nature. In many of these matters, cooperation is requested from the industry stations in supplying information which can best be presented to the FCC by an over-all industry spokesman. Such information is often basic to formulating the entire position of NARTB.

How the Department Helps Stations

One question perhaps needs a little elaboration, namely how can member stations of NARTB use the Engineering Department. First, it should be explained that the constitution and by-laws of the Association preclude the Department from engaging in a consulting practice in competition to established firms. The Department is not permitted to conduct a frequency search, design a directional antenna, make a proof of performance, adjust equipment or other things normally performed by a consulting engineer. In looking over the approximately 1000 letters per year which are answered, several subjects are representative of ways the Department serves member stations. For the most part, large stations have their own facilities for securing information, consequently, it is the smaller station which most often writes for necessary data.

Such diverse subjects covered are:

What frequencies can I use for a remote pickup?

Is the local common carrier justified in refusing me a line from my remote pickup receiver to my studio?

Why does a Class B line cost so much and what recourse do I have if the service provided is not satisfactory?

Can my station sign-on at 4 A.M. local time without permission of the FCC?

Why can't we operate until 7:15 P.M. as does my competitor?

AUTOMATIC GAIN CONTROLLED AUDIO PROGRAM AMPLIFIER

**Maintains Nearly Constant Average Output Level Over Wide Variations
of Average Input Level and Reacts Practically Instantaneously**

by GEORGE A. SINGER, *RCA Broadcast and Television Engineering*

The new BA-25A AGC Program Amplifier has been specifically designed for the requirements of the modern broadcast station or recording studio. Now, more than ever, there exists a demand for maintaining a constant average output level, yet wide variation in program input level are frequently experienced. This is particularly true when the program is a live pickup in a television studio where the distance between performer and microphone is subject to considerable fluctuation. Variations in program level are also frequently encountered when switching from one program source to another. At the same time, there is the desire to lessen the need for manual level adjustment and also to improve performance. The AGC program amplifier fulfills this requirement by automatically controlling variations in audio program levels. In addition feedback circuits in this amplifier provide excellent frequency response and extremely low harmonic distortion.

The BA-25A will find wide applications in audio systems. It is particularly suited as a studio amplifier to maintain constant output level when feeding the control room or transmitter, or it may be used in conjunction with film projectors, turntables or tape recorders to equalize differences in output level of the various makes of films, records and tapes. It may be used advantageously in the recording of sound on any medium to permit a higher recording level and yet prevent overloading. The BA-25A is ideal for use in a remote location where the program is to be transmitted over telephone lines or microwave relay to the studio. Here again, distortion from overloading and interference from other channels may be reduced and signal-to-noise ratio may be improved.

Compression of Output

As the name implies, an automatic gain-controlled audio program amplifier is one whose gain is not constant as in the usual

audio amplifier, but is a function of the input level. There are two basic types of automatic gain controls—the compressor and the expander. The compressor causes variations in average output level to be less than the corresponding variations in input level. The expander causes output levels to vary over a wider range than the corresponding input levels. In radio and television broadcasting and in sound recording it is the compressor which finds the greater number of applications for automatic gain control.

A special type of AGC amplifier is the limiting amplifier.¹ In the limiting amplifier, the gain is constant up to a certain output level. Above this level, there is so much gain reduction that the output level will be maintained virtually constant. In audio work it is of course essential that the output waveform be a faithful reproduc-

¹ "New Limiting Amplifier, Type BA-6A." BROADCAST NEWS, Vol. 63, April, 1951.

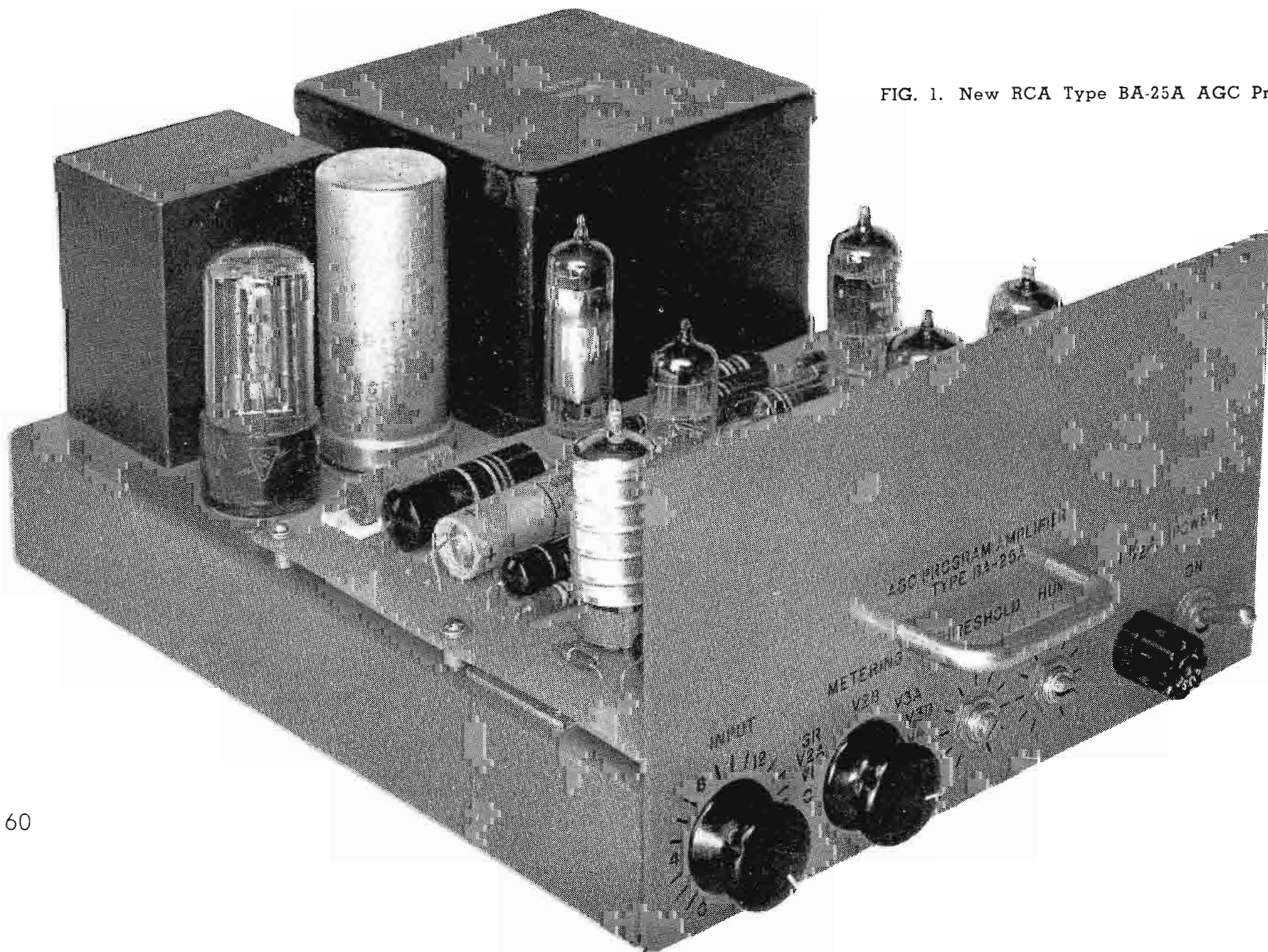
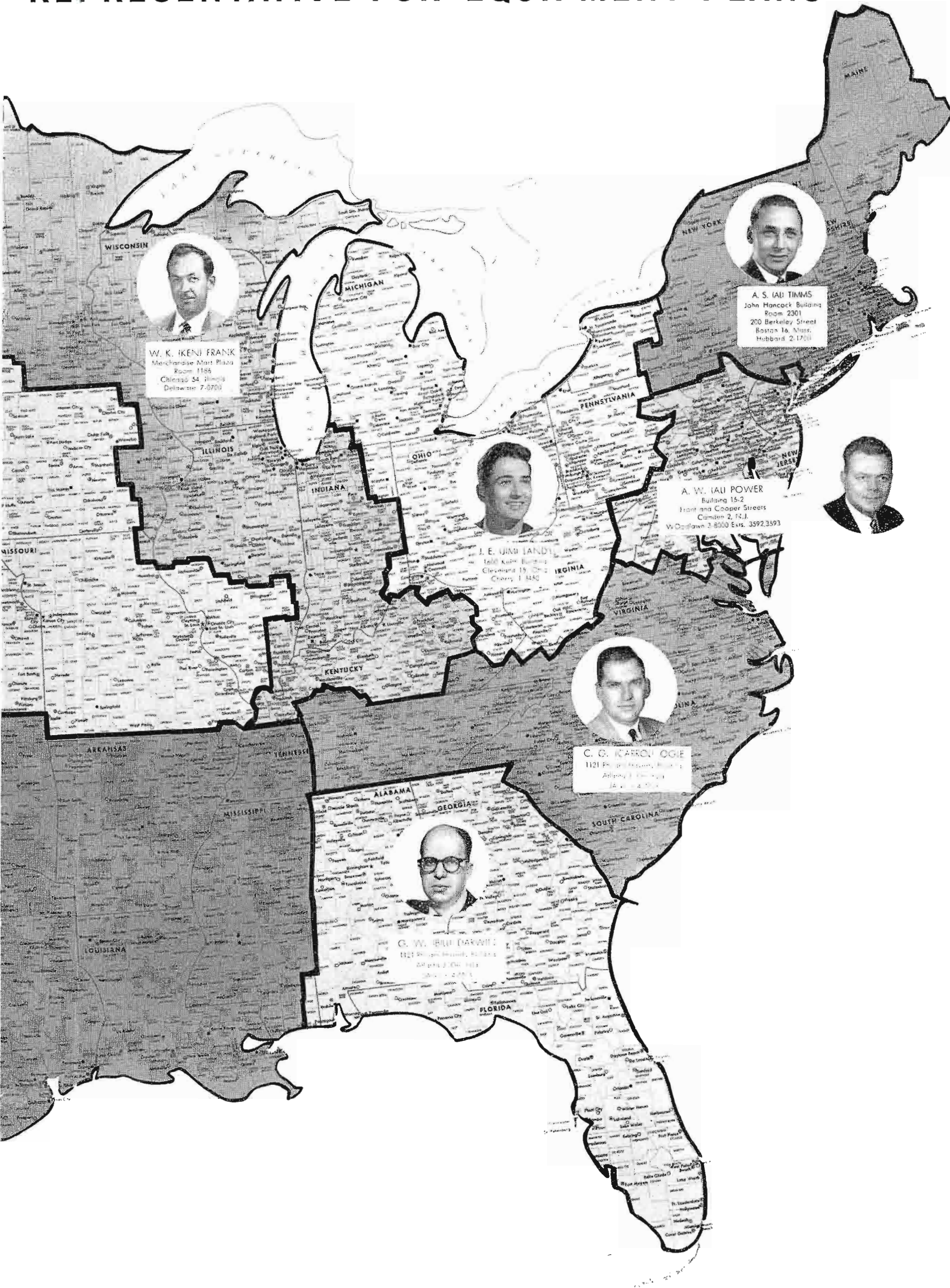
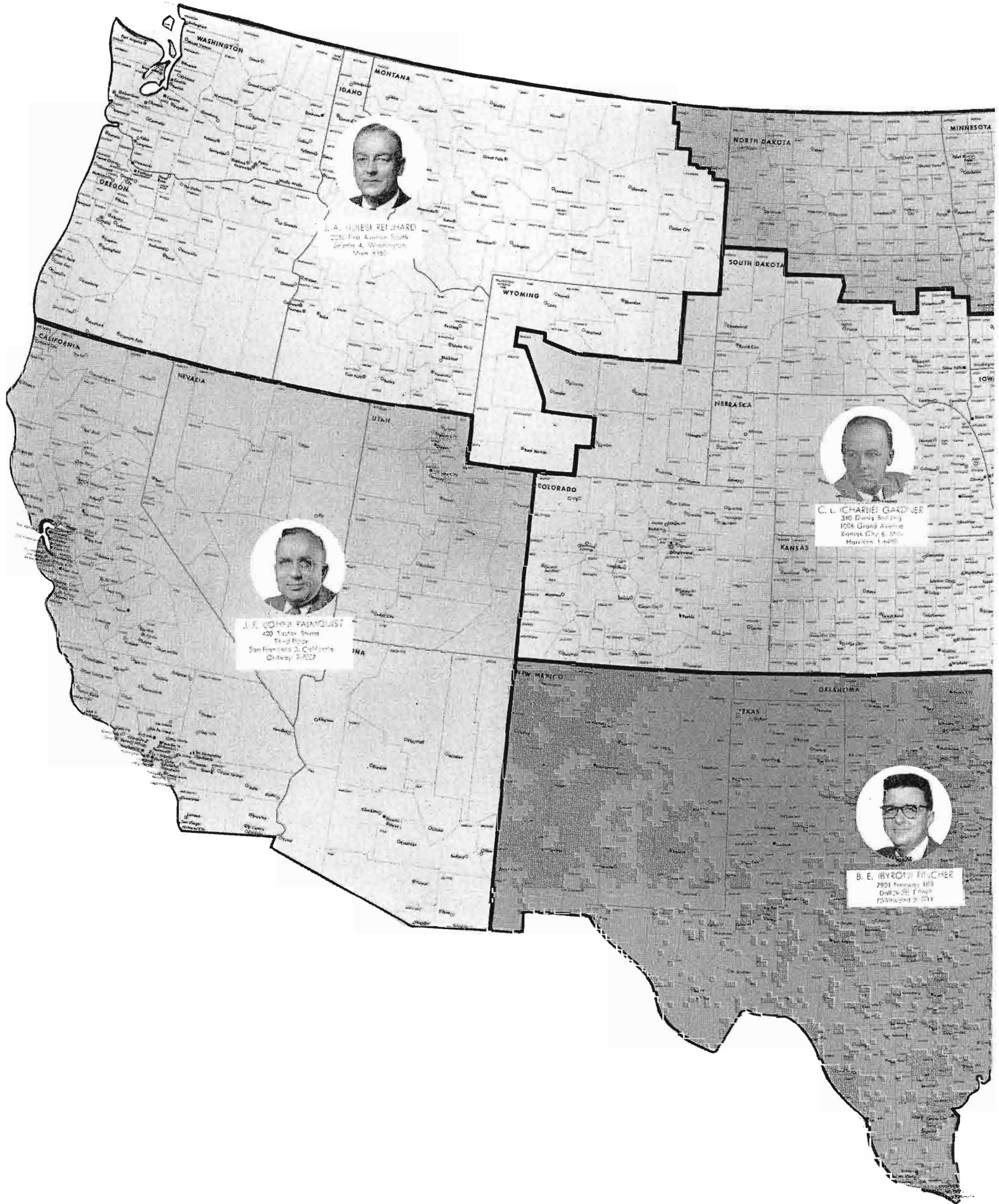

FIG. 1. New RCA Type BA-25A AGC Program Amplifier.

REPRESENTATIVE FOR EQUIPMENT PLANS



SEE YOUR NEAREST RCA BROADCAST AM



REGIONAL REPRESENTATIVE FOR EQUIPMENT PLANS



F. A. (TIM) TIMBERLAKE
 Merchandise Mart Plaza
 Room 1186
 Chicago 54, Illinois
 Telephone: Delaware 7-0700



M. M. (MARSH) CARPENTER
 Merchandise Mart Plaza
 Room 1186
 Chicago 54, Illinois
 Telephone: Delaware 7-0700



D. S. (DAVE) NEWBORG
 1600 Keith Building
 Cleveland 15, Ohio
 Telephone: Cherry 1-3450



J. R. (JOE) SIMS
 John Hancock Building
 Room 2301
 200 Berkeley Street
 Boston 16, Massachusetts
 Telephone: Hubbard 2-1700



J. P. (JOE) ULASEWICZ
 John Hancock Building
 Room 2301
 200 Berkeley Street
 Boston 16, Massachusetts
 Telephone: Hubbard 2-1700



R. S. (BOB) EMCH
 1600 Keith Building
 Cleveland 15, Ohio
 Telephone: Cherry 1-3450



J. L. (JESS) NICKELS
 Merchandise Mart Plaza
 Room 1186
 Chicago 54, Illinois
 Telephone: Delaware 7-0700



J. F. (FRANK) MYERS
 1600 Keith Building
 Cleveland 15, Ohio
 Telephone: Cherry 1-3450



A. (AL) JOSEPHSEN
 36 West 49th Street
 New York 20, New York
 Telephone: Judson 6-3800



J. F. (FRANK) INGELS
 340 Dierks Building
 1005 Grand Avenue
 Kansas City 6, Missouri
 Telephone: Harrison 1-6480



G. F. (GERRY) RESTER
 Front and Cooper Streets
 Camden, New Jersey
 Telephone: Woodlawn 3-2000



J. H. (JIM) KEACHIE
 1625 "K" Street, N.W.
 Washington, D.C.
 Telephone: District 7-1260



P. (PAUL) BERGQUIST
 1625 "K" Street, N.W.
 Washington, D.C.
 Telephone: District 7-1260



W. D. (WILEY) WENGER
 7901 Freeway 183
 Dallas 35, Texas
 Telephone: Fleetwood 2-3911



P. G. (PG) WALTERS
 1121 RHODES HAVERTY BLDG.
 Atlanta 3, Georgia
 Telephone: Jackson 4-7703



J. W. (JOHN) HILLEGAS
 1121 RHODES HAVERTY BLDG
 Atlanta 3, Georgia
 Telephone: Jackson 4-7703



M. R. (MILT) NORTON
 7901 Freeway 183
 Dallas 35, Texas
 Telephone: Fleetwood 2-3911



J. M. (JOE) WALTERS
 1121 RHODES HAVERTY BLDG
 Atlanta 3, Georgia
 Telephone: Jackson 4-7703

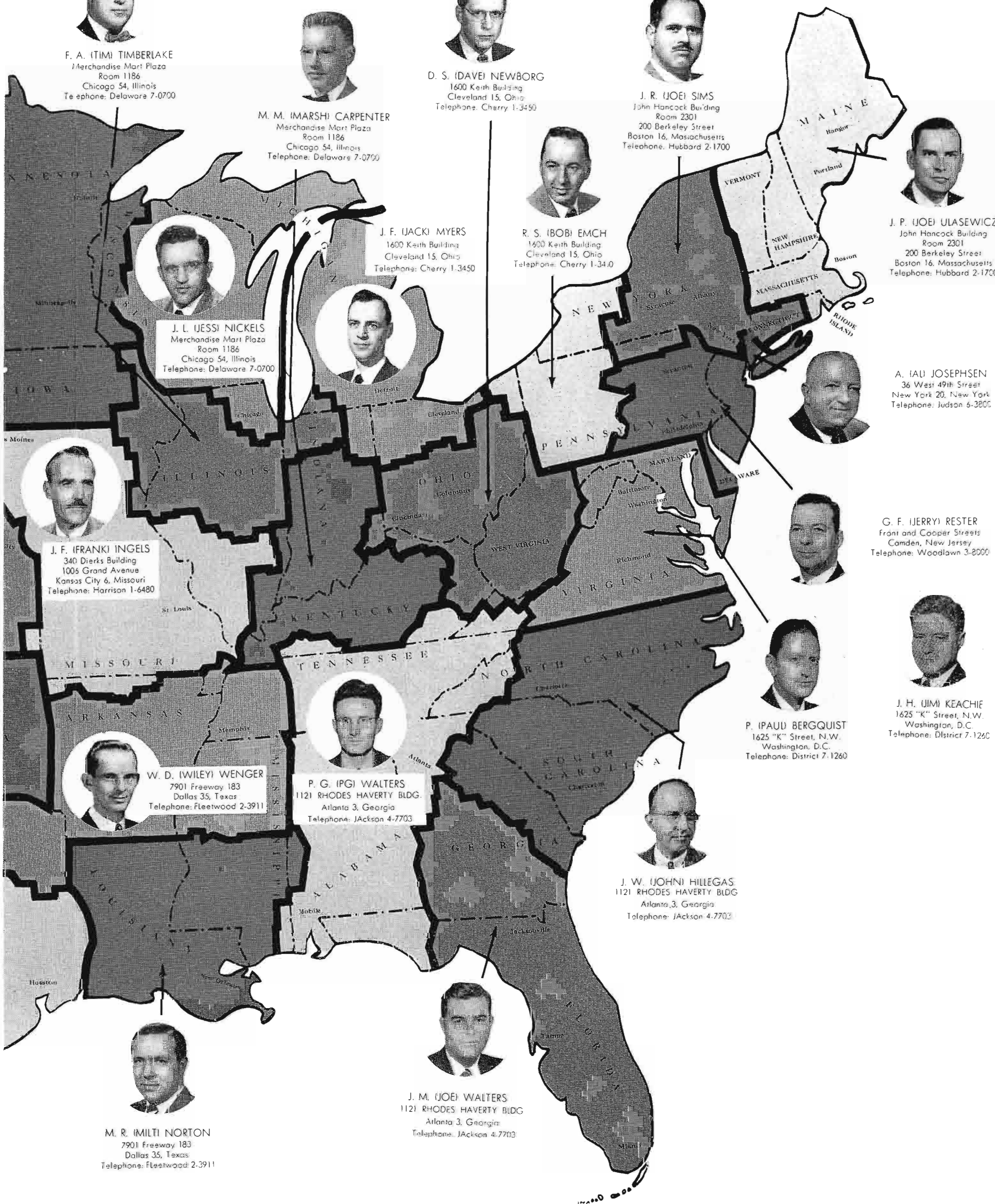

SEE YOUR NEAREST RCA BROADCAST AND TELEVISION

O. E. (ORT) WAGNER
 2250 First Avenue, South
 Seattle 4, Washington
 Telephone: Main 8350

W. G. (WOODY) EBERHART
 Merchandise Mart Plaza
 Room 1186
 Chicago 54, Illinois
 Telephone: Delaware 7-0700

R. J. (DICK) NEWMAN
 420 Taylor Street
 Third Floor
 San Francisco 2, California
 Telephone: Ordway 3-8027

E. (JACK) FROST
 1560 North Vine Street
 Hollywood 28, California
 Telephone: Hollywood 9-2154

J. S. (JOHN) ALMEN
 340 Dierks Building
 1036 Grand Avenue
 Kansas City 6, Missouri
 Telephone: Harrison 1-6480

R. E. (RALPH) SMITH
 1560 North Vine Street
 Hollywood 28, California
 Telephone: Hollywood 9-2154

E. H. (HERB) HOFF
 7901 Freeway 183
 Dallas 35, Texas
 Telephone: Fleetwood 2-3911

J. N. (JIM) BARCLAY
 7901 Freeway 183
 Dallas 35, Texas
 Telephone: Fleetwood 2-3911

achieve uniform field strength within the area. The result is a high gain antenna with an excellent omnidirectional pattern. For details, see the complete story, page 44 of this issue.

Compact New VHF Transmitter for Low Power Applications

Housed in only two BR-84 Cabinet Racks, the new RCA TTL-500AL/AH 500 Watt Transmitters offer highly economical low-power originating or satellite operation. The transmitters utilize the RCA TTL-100A, introduced last year, as a driver. They incorporate a newly designed aural visual exciter to maintain extremely accurate spacing between carriers for improved monochrome and color operation.

Lightweight and compact, the transmitters are easy and economical to install. Air-cooled tubes are used throughout; all tubes are easily obtained, inexpensive and dependable. The TTL-500AL is for use on channels 2 through 6; the TTL-500AH, on channels 7 through 13.

Professional Slide Projector Added to Film Line

In the film area of the RCA display, broadcasters will have an opportunity to see the new TP-7 Slide Projector in operation. The TP-7 couples maximum operating convenience with the latest technical improvements in projector design.

Its many features include: high capacity (dual drums hold 36 slides) easy loading, slide check viewing, quick lamp change, and suitability for use in existing film systems, color or monochrome. Details of this outstanding new projector can be found starting on page 64 of this issue.

The TP-7 will operate at the exhibit with an RCA color film system. The system will include TK-26 Color Film Camera, TP-15 Universal Multiplexer, TP-6 Film Projector, TP-7 Slide Projector, and control and monitoring equipment.

Highly Stable 21-Inch Color Monitor

Color pictures from live and film cameras will be presented on new Color Monitors, Type TM-21. The extremely high stability and uniformity of this monitor makes it an excellent station standard on which the performance of color equipments and systems may be judged.

The TM-21 incorporates a myriad of technical advances including feedback stabilization throughout, kinescope protection from loss of horizontal deflection or video overdrive and vertical chassis construction for utmost accessibility. In addition, all significant voltages are regulated for stability, operating controls are grouped

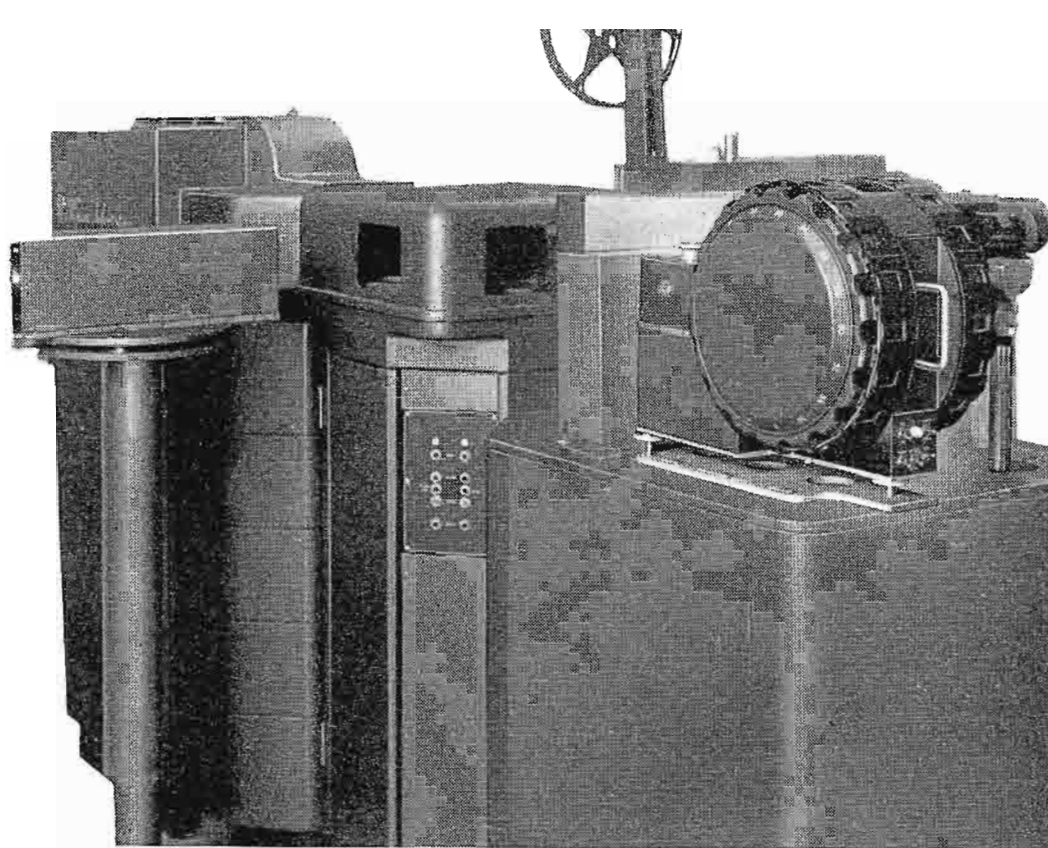

FIG. 3. Professional 2 x 2 Slide Projector, TP-7, is designed to operate with any RCA Vidicon Film System; features high capacity, quick lamp change and slide check viewing.

on the front panel for convenience and an underscan switch has been provided so that all four corners of the picture can be examined.

Completely Equipped Radio Station

A completely equipped radio station will be in simulated operation within the exhibit area. This display will include all equipment necessary for efficient, economical station operation. Included will be a 1 KW AM Transmitter, BTA-1MX; representative AM Tower Section, Antenna Tuning Unit; Audio Console, BC-3B; Random Selection, Automatic Turntable, BQ-102; 3-Speed Turntable, BQ-2B; Tape Recorder, SRT-2; and rack-mounted audio signal equipments.

Universal Coaxial Transmission Line

Three complete new series of coaxial transmission line and accessories will be displayed. New 3 1/8 inch and 6 1/8 inch series are universally suited for use on channels 2 through 83. Also a 9-inch series of line and accessories suitable for use on channels 2 through 40 will be introduced. This new size line features power ratings and efficiency similar to waveguide.

Rugged new mechanical design is featured in all three new series of line. Pre-

viously used bolted flanges have been superseded by interlocking connector-type flanges held together by Marman clamps.

Audio and Video Equipments for Studio Modernization

A number of audio and video equipments for modernization of radio and TV studios will be featured in special display. These equipments are designed to simplify studio layout, increase operating efficiency and increase signal handling capabilities. New audio equipment includes an AGC Audio Amplifier, BA-25; a Tape Recorder, SRT-2 and a Transistor Turntable Amplifier. New video equipment includes a Universal Stabilizing Amplifier, TA-9; an orbital wedge for the TK-41 Color Studio Camera; 17 and 21-inch Utility Monitors, TM-8C; a Monochrome AGC Amplifier, TA-21A; a Switching Control Panel, TS-21A; a Magnetic Stripe Kit for TP-6 Projectors, and a complete line of rack mounting accessories for TVM-1A Microwave Equipment.

These equipments for radio and TV broadcasters will incorporate all the latest advances achieved by RCA engineers. Plan to visit the display; RCA representatives will be on hand to demonstrate the equipment and assist in any way possible.

FIG. 4. Designed for use on all television channels, 2 through 83, two newly designed series of transmission line are available in 3 1/8 inch and 6 1/8 inch sizes.



NARTB CONVENTION PREVIEW

New Equipments for Radio and Television Stations
to be Featured in RCA Display

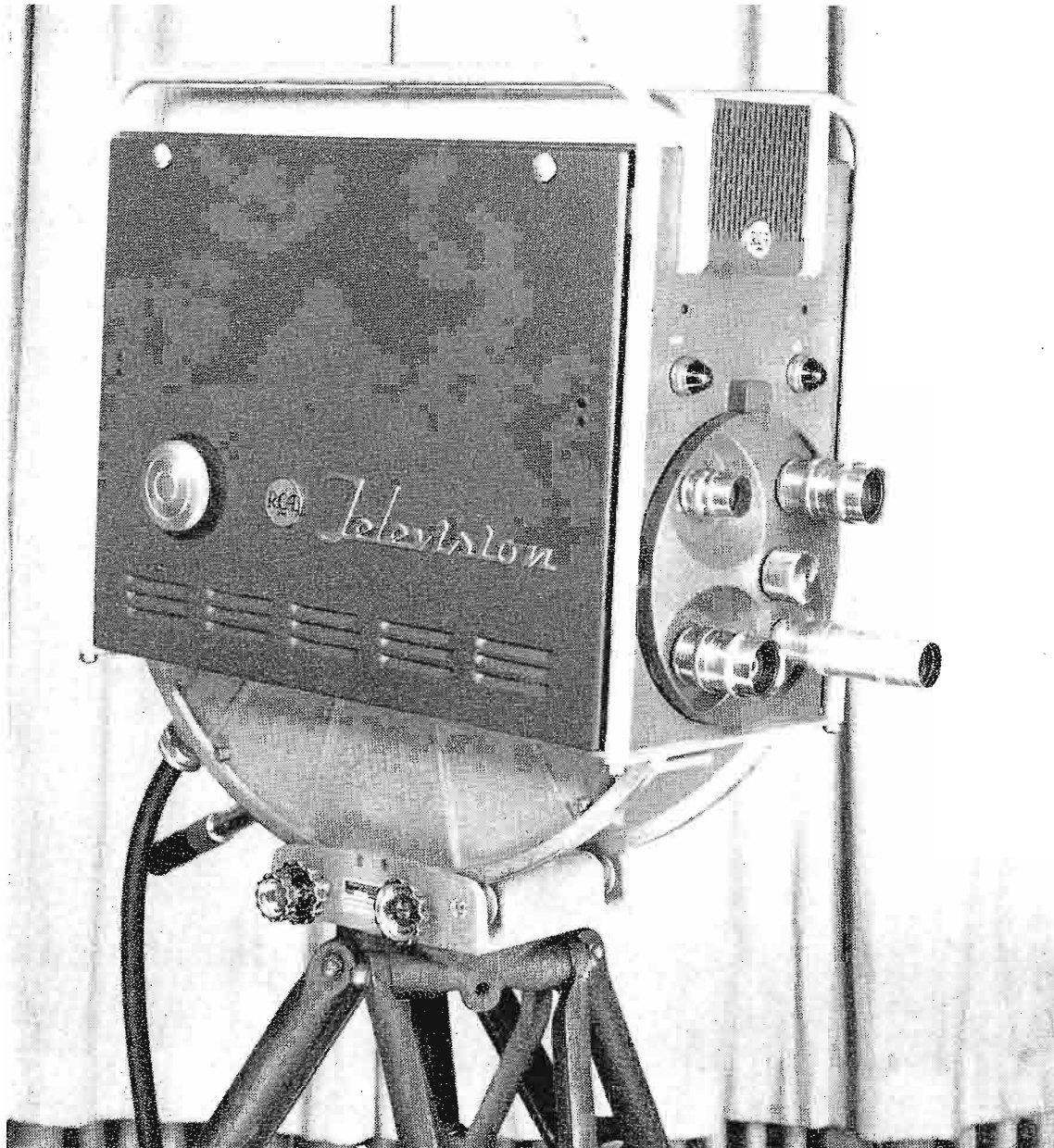

FIG. 1. Vidicon Studio Camera, Type TK-15, offers operating economy of the vidicon tube in a camera designed to broadcast standards. This new camera features a built-in 7 inch viewfinder and 4-lens turret for broadcast operations.

TK-15 Vidicon Camera Featured in Live Studio

A new vidicon camera for broadcast use will operate from a live studio which is also equipped with a TK-41 Color Camera. The two cameras will operate side by side and serve as continuous sources of both monochrome and color pictures throughout the RCA area.

The new TK-15 Vidicon Camera offers the economy of vidicon operation in a camera designed to broadcast standards. RCA broadcast engineers have incorporated the latest in techniques and circuitry into this vidicon camera for studio use. The result is a camera which offers the same kind of operating convenience as other RCA broadcast cameras. It will provide the broadcaster with high-quality pictures for flip card commercials, live news programs and other scenes properly lighted for vidicon reproduction.

The new camera will be displayed in an operating studio. Among its advanced features are built-in 7-inch viewfinder and 4-lens turret for broadcast operation, quick and precise optical focus by means of a nonlinear focus mechanism and feedback stabilized circuitry for easy setup and operation. A 14-inch rack mounted output amplifier may also be housed in a field case for remotes. As with other RCA broadcast cameras—complete accessibility is offered throughout.

TW Antenna for High Channel Applications

Two sections of a new Traveling Wave Antenna for operation on the VHF high band will be displayed for the first time. This antenna combines appreciable improvements in electrical characteristics with mechanical simplicity and economy, especially in high gain, high power applications.

Mechanically the antenna consists of a long pole in which vertical slots are cut. The horizontal pattern is based on the turnstile principle and formed from the patterns of single slot pairs. A smooth vertical pattern, based on the exponentially decaying traveling wave feed, helps to

Latest advances in RCA Broadcast equipment for radio and television stations will be on display at the 35th annual NARTB convention at the Conrad Hilton Hotel, Chicago, April 7-11. Among the major new equipments which will be shown for the first time are a vidicon studio camera for broadcast use, a professional 2 x 2 slide projector, a 21-inch color monitor and several new audio and video equipments for studio modernization. Also to be shown are a new VHF traveling wave antenna, 500 watt high-band VHF television transmitter and a complete display of universal transmission line. These will be displayed along with many other RCA equipments for radio and television broadcast operations.

FIG. 2. New 500 Watt Transmitters, TTL-500AL and 500AH, offer highly economical, low power operation. Both are lightweight and compact, and are housed in only two BR-84 cabinet racks.

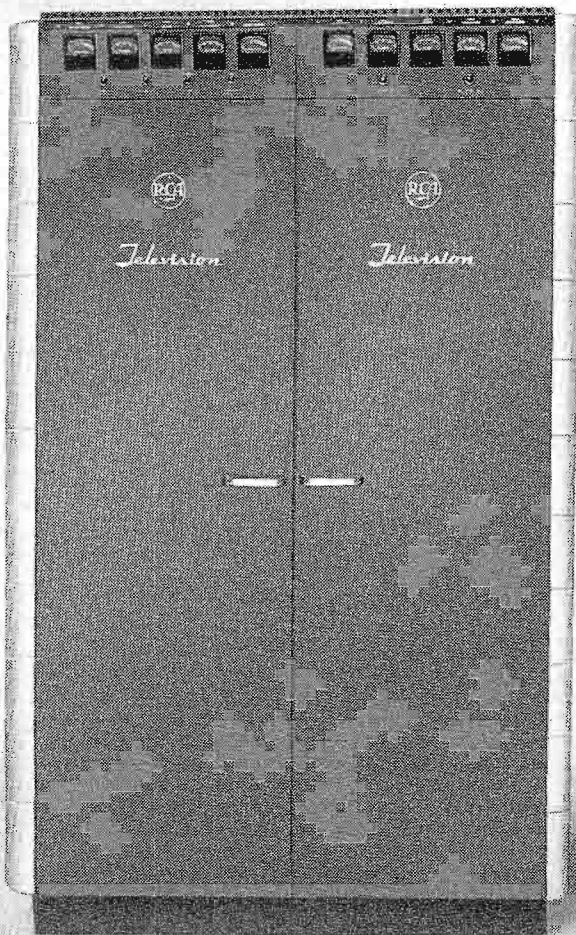

What steps must I take if my Chief Engineer is ill and unable to work for several months?

Is it true that 5 kw on a low frequency is the equivalent to a much higher power on a high frequency in the standard broadcast band?

What is high fidelity broadcasting?

Where can I obtain a used FM transmitter?

I use remote control during periods of non-directional operation so why can't I use the same procedure at night while using a directional antenna?

A station in a neighboring country is causing interference to my 0.1 mv/m service contour, is this to be tolerated and what can I do about it?

Who makes multiplex equipment for FM stations?

How can I make an audio pickup from across a football field?

Where can I obtain information about bin-audal broadcasting?

What are the merits of shunt fed antenna and how about using top loading?

Where can I obtain some representative floor plans for a modern station?

My application has been on file with the FCC for six months . . . why hasn't FCC taken action and what is its present status?

My station has been off the air due to a strike . . . what must I do to resume broadcasting on a regular basis?

What additional service will I obtain by increasing power to 1 kw?

Am I apt to get approval from Airspace for a tower 1200 feet high to be located 3 miles within a federal airway?

We are considering installation of an STL . . . in view of the reallocations study now under way, should we proceed or wait until it is settled?

Is there a station in my area using automatic programming equipment?

Publications

Over the past few years various publications of the Engineering Department have been made available to member stations. Most stations are familiar with the NARTB Engineering Handbook, a technical manual of 650 pages. This was last published in 1949 and is now out of print and being revised. The new Engineering Handbook will be published by McGraw-Hill and will be available initially to NARTB member stations at no cost, and later to others desiring to purchase it. Another publication which has proved of great value is entitled "Frequencies Used by the Broadcast Services" which saves considerable time in determining which channels are available for broadcasting, remote pickups, STL's, intercity microwave relays, etc. An interesting aspect to this was that upon publication, the FCC asked for 50 copies for their use.

"CONELRAD Simplified" is another information source which has answered many questions on this emergency system of broadcasting.

1957 ENGINEERING CONFERENCE

Monday, April 8, Morning Session: RADIO

- 9:00— 9:15 Opening of Engineering Conference.
9:20— 9:45 A New 50-KW AM Transmitter Designed Around Modern Components.
9:50—10:05 Progress report on NARTB's petition for an extension of remote control and current experiments in automatic logging.
10:10—10:35 Automatic Recording of the Critical Parameters of a Directional Antenna System and a Standard Broadcast Transmitter.
10:40—11:05 The Radio Station of the Future.
11:10—11:45 Keeping Standard Broadcast Transmitters Up to Date.
12:00 Noon Engineering Reception and Luncheon.

Monday, April 8, Afternoon Session: TELEVISION

- 2:30 — 2:55 Operational Considerations of the Ampex Videotape Recorder.
3:00 — 3:25 Operating Experience with Video Tape.
3:30 — 3:55 Control of Color Appearance in TV Studio Lighting.
4:00 — 4:25 Color Television Test Signals.
4:30 — 5:00 ChromaCHron.

Tuesday, April 9, Afternoon Session: RADIO

- 2:30 — 2:55 A Compatible Single Sideband System Designed for Use in the Broadcast Service.
3:00 — 3:25 A New Approach to Audio Consoles.
3:30 — 3:55 Design and Integration of Automatic Program Equipment.
4:00 — 4:25 Bringing Radio to the Public.
4:30 — 5:00 Application of Modern Techniques in Making Good Recordings.

Wednesday, April 10, Afternoon Session: TELEVISION

- 2:30 — 2:55 Special Effects in Color Programming.
3:00 — 3:25 New Field Intensity Measuring Techniques.
3:30 — 3:55 A Television Aural Transmitter Standby System.
4:00 — 4:25 The Application of Very Precise Frequency Control in Minimizing Co-channel Interference.
4:30 — 5:00 The FCC Mobile Unit and Its Use in Measuring TV Transmissions.

Thursday, April 11, Morning Session: TELEVISION

- 9:00— 9:25 Advanced Performance and Stability in Color TV Film Channel Amplifiers.
9:30— 9:55 Video Switching at Television Operating Centers.
10:00—10:25 Low Power Television Station Operation.
10:30—10:55 The Color Studios of "WRAMC".
11:00—11:25 The Use of a 100-KW Transmitter to Obtain 316-KW ERP.
11:30—12:00 A New Lease on Life for Retired Image Orthicons.

Thursday, April 11, Afternoon Session: TELEVISION

- 2:30 — 2:55 UHF Translator Operation.
3:00 — 3:25 Progressive Steps Toward Automation in Television Programming.
3:30 — 3:55 Tower Design, Construction, and Maintenance.
4:00 — 4:25 A High Gain Low Cost Emergency or Auxiliary Antenna System.
4:30 — 5:00 Predicting the Operating Characteristics of Closely Spaced Antennas on the Same Supporting Structure.

FIG. 4. Engineering Conference Committee for 1957 NARTB Convention. Standing left to right: Thad H. Brown, William S. Lodge, John Shay, Harold See, George L. Bartlett, Ray Guy, Jess Slusser and John Meagher. Seated left to right: John Wilner, Harry Tilley, Prose Walker, John Leitch, Ross Beville and Joe Epperson.



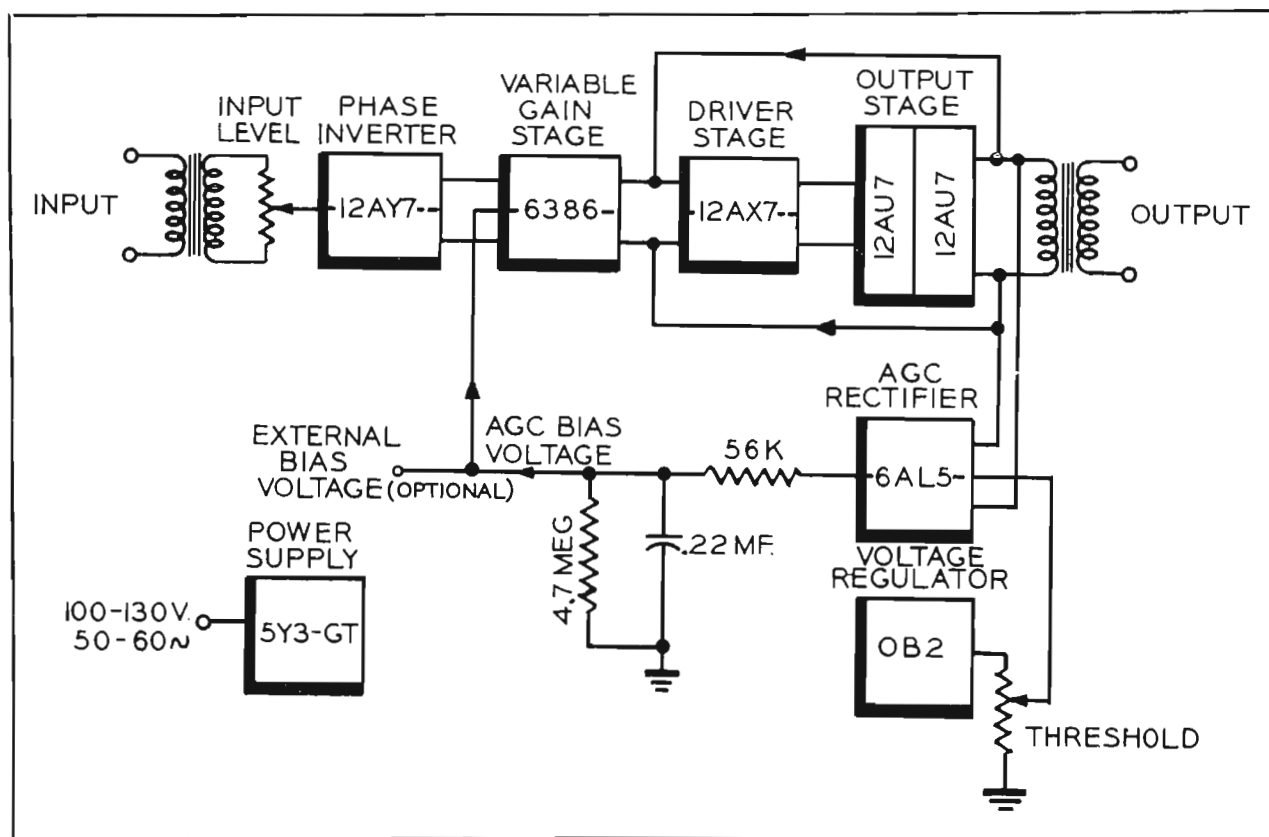

FIG. 2. Simplified block diagram of AGC program amplifier. Use of external bias source permits automatic fading or remote gain control.

tion of the input waveform at any constant level or the program would sound distorted, therefore AGC amplifiers should not be confused with peak clippers.

The compression characteristics of the BA-25A AGC Program Amplifier and the limiting characteristic of the BA-6A Limiting Amplifier supplement one another ideally when connected in a system feeding a transmitter. This combination permits maintenance of a higher average degree of modulation and prevents overmodulation on sudden program peaks which effectively improves reception in fringe areas and extends coverage without increasing transmitter power.

Reaction Time

Now let us compare manual level control with automatic. Ordinarily the operator adjusts the mixer and master-gain controls of the audio console as he listens to the program on the monitor speaker and watches the VU meter to maintain the desired constant output level. In the BA-25A AGC Program Amplifier, the output signal is compared to reference voltage and as the signal reaches a predetermined level, the amplifier gain is automatically reduced, consequently limiting the increase in output above that level. While it is true that an operator may, through practice, training and the use of score or script, anticipate changes in level with corrective action, his reactions will normally lag behind the controlled signal. The reaction time of the BA-25A AGC Program Amplifier is 40 times as fast as that of a human being and

may therefore, for all practical purposes, be considered instantaneous.

Principle of Operation

The operation of the AGC program amplifier may best be explained by referring to the block diagram of Fig. 2. The input signal is applied through an input transformer and input level control to a phase inverter, which in turn drives a push-pull variable-gain stage utilizing a type 6386 variable-mu twin triode. It is a well known fact that the more negative the grid bias voltage applied to such a tube, the less is its amplification. The output signal from this stage is fed to a push-pull voltage amplifier and output stage and hence to the output transformer.

A small portion of the output signal is rectified by a full-wave rectifier. However, a positive bias voltage, which is adjustable by means of the "Threshold" control, prevents rectification of the signal until it exceeds the threshold. The rectified signal, which is negative in polarity, is filtered through a resistance-capacitance network which has a fast (12.5 millisecond) charge time constant and a slow (1 second) discharge time constant, and applied to the grids of the variable gain stage.

As the input signal increases, the output increases proportionately, as in any linear amplifier, until the output level reaches the threshold value. The higher the output level tends to rise above this value, the greater becomes the negative grid-bias voltage. Thus, the gain of the variable gain stage is reduced and consequently the

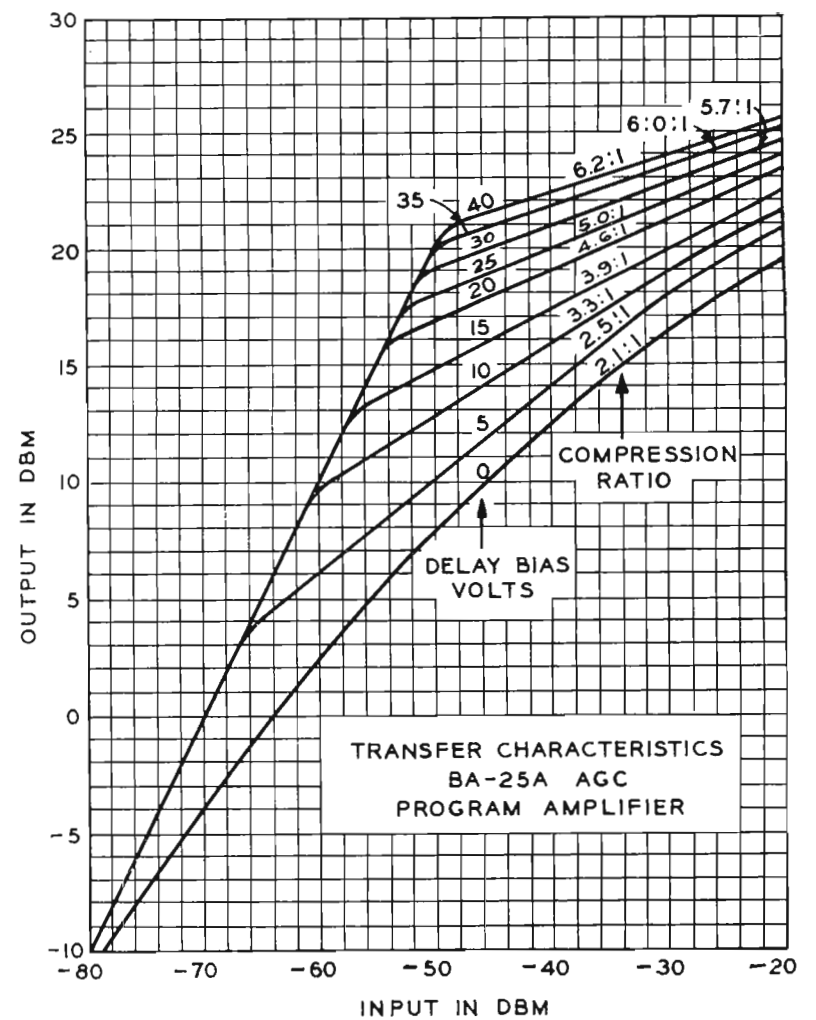

FIG. 3. Output versus input curves for the BA-25A amplifier for various values of positive delay bias.

increase in output level becomes smaller. This constitutes a closed feedback loop.

Transfer Characteristics

The resultant transfer characteristics of the amplifier, that is, the relation of output level to input level for various values of positive "delay" bias, are shown in Fig. 3. As may be seen from the transfer characteristics, the slope of the curves above the threshold becomes less steep as the delay bias is increased. The ratio of the change in input level to the corresponding change in output level is called the compression ratio. The curves show that the compression ratio may be adjusted from about 2.5 to 1 for 5-volt delay bias to about 6 to 1 for 40-volt delay bias.

Figure 4 shows the gain control characteristic of the variable gain stage. Note that the gain is reduced 60 db at -45 volts control bias from the maximum gain at 0 volt bias. This characteristic is independent of frequency over the audio range. Since the signal amplitude at the grids of the 6386 triode is relatively small, and since this tube has a remote cutoff characteristic, the waveform at the grid is faithfully reproduced at the plate. Thus, it is possible to hold the harmonic distortion to less than one per cent over the entire 30 to 15,000-cycle operating range of the BA-25A amplifier.

Measuring Gain Reduction

The control bias does of course determine the plate current of the tubes. It is therefore possible to obtain an indication

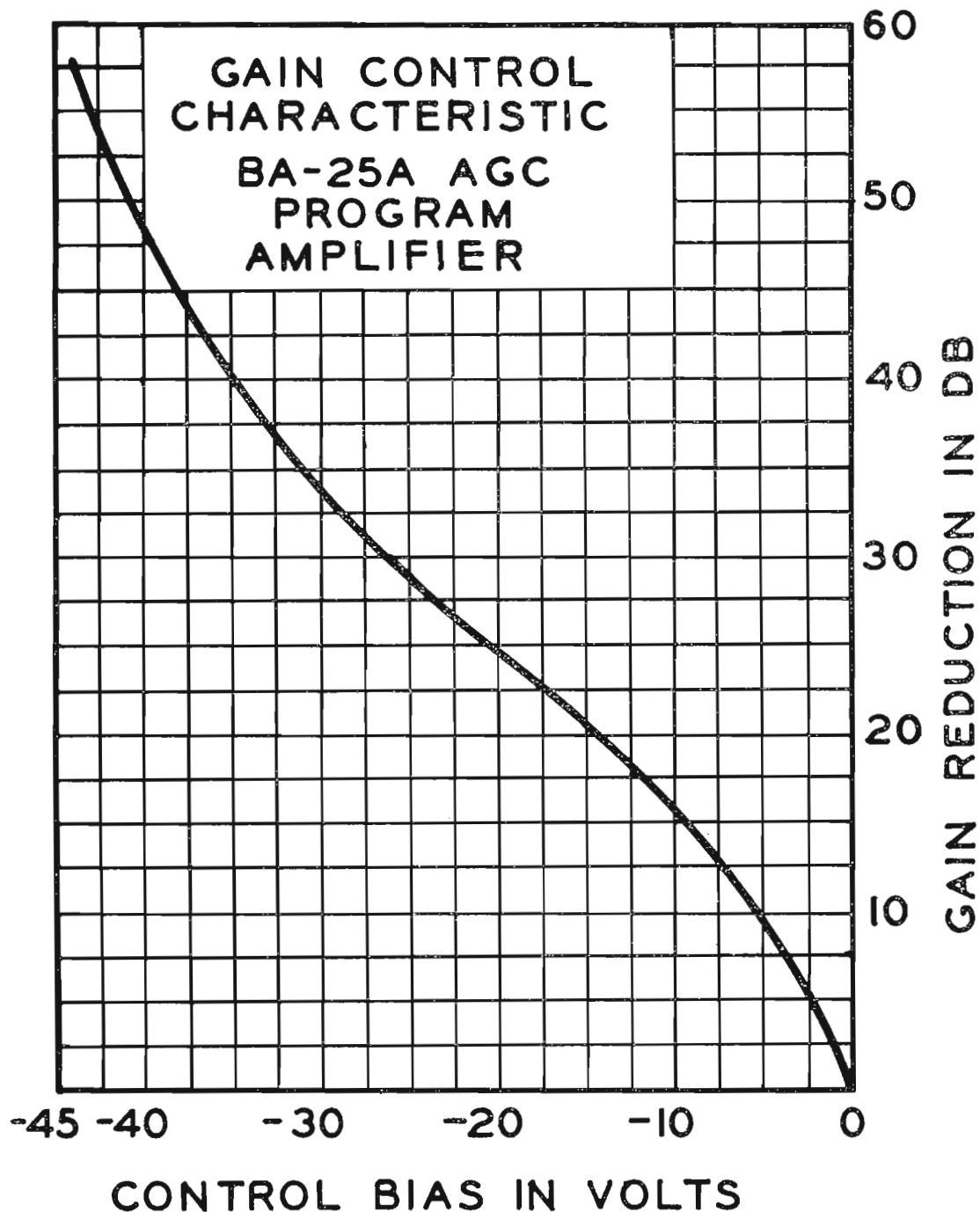

FIG. 4. Gain control characteristics of the variable gain stage of the AGC amplifier.

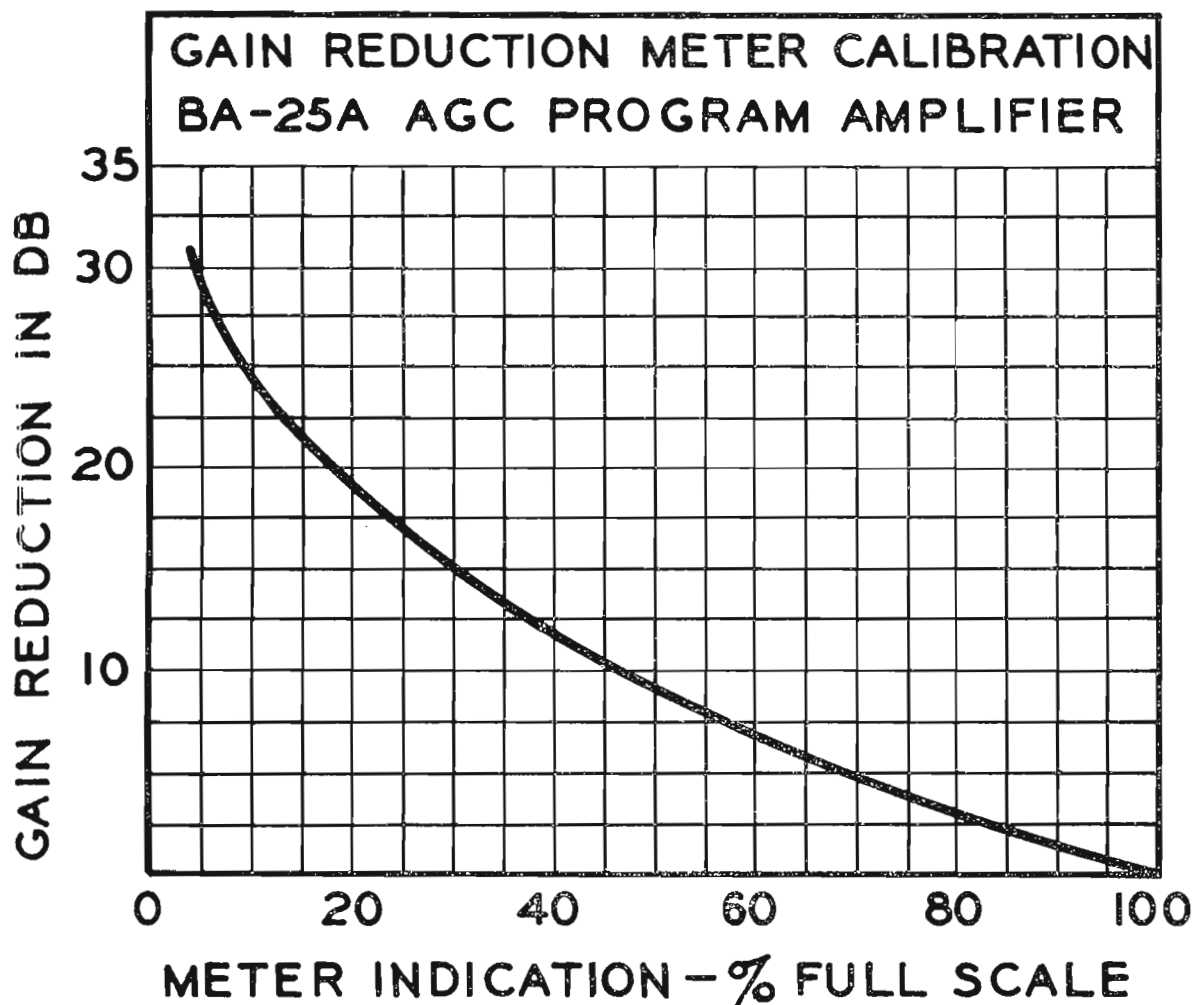

FIG. 5. Indication of gain reduction is obtained by measuring voltage drop across the cathode resistors of the variable gain stage.

of gain reduction by measuring the voltage drop across the cathode resistors of the variable gain stage. To indicate gain reduction any 200-microampere dc meter or standard VU meter may be connected in series with a 10,000-ohm variable resistor to terminals provided on the connector plug. The variable resistor is adjusted until the meter indicates 0 db gain reduction at full-scale deflection while no input signal is applied to the amplifier. The curve in Fig. 5 may be used to calibrate the meter scale in db of gain reduction.

Circuit Features

In a single-ended circuit, the change in plate current due to an increase or decrease in control-bias voltage caused by changes in input level would introduce an objectionable transient which would be heard as a "thump." In the push-pull circuit used in the BA-25A, the AGC bias voltage appears in phase on both grids of the variable-gain stage and the transient is consequently cancelled out. To accomplish this, it is essential that the impedances in the grid circuits of the two variable-gain triodes be equal or the instantaneous amplitude of the control-grid bias at the two grids would differ. This was the reason for choosing a common-cathode type of phase inverter circuit to drive the push-pull variable-gain stage.

Another circuit feature, which is not too commonly found in audio equipment, is the use of two coupling capacitors connected in series between the plates of the phase inverter and the grids of the variable gain stage. A 1.8-megohm resistor is connected from the junction of each of the two pairs of capacitors to ground. This limits the potential gradient across the second capacitor to a very small value and thus prevents a positive voltage from leaking from the plates to the grids, which have a high resistance to ground.

In addition to automatic gain control, the variable gain feature of the BA-25A may be utilized for remote gain control by applying a negative bias from an external source. If this voltage is derived through a charge-discharge circuit it is possible to fade a program in or out by operating a s.p.d.t. switch or relay.

Chassis Layout

The BA-25A AGC Program Amplifier is constructed on a plug-in chassis small enough for two amplifiers to be installed side by side on a BR-22A Mounting Shelf. This shelf requires only $5\frac{1}{4}$ inches of rack space. All controls are located on the front panel where they are in plain view and

easily accessible when the hinged front cover of the mounting shelf is pulled down. A metering switch is provided for convenient checking of the cathode current of the amplifier tubes. The other controls are input level, threshold, hum adjustment and power switch.

An etched wiring board is used for the amplifier circuitry proper as well as the tube sockets. This method of construction was found to yield greater uniformity of performance than conventional wiring. The components are arranged on the top of the board in an orderly fashion which facilitates inspection, identification and replacement. The etched wiring side of the board is exposed through a large cutout in the chassis to permit easy servicing.

Specifications

The ac operated power supply is self-contained. A voltage-regulator tube and use of negative feedback stabilize the amplifier performance and make it insensitive to line-voltage variations. The ac power requirements are 55 watts, 50/60 cps and 100/130 volts. A push-pull parallel-output stage permits adequate emergency operation even with one of the 12AU7 output tubes removed. The input, output and power transformers are of sealed construction to insure the highest degree of reliability.

The AGC program amplifier is shipped from the factory with input and output transformers connected for 600-ohm source and load impedances. The transformer connections may, however, be easily changed for 150-ohm impedances. The maximum gain at 1000 cps is 70 db which may be reduced by means of the input level control. Frequency response is within ± 1 db of the 1000-cps reference over a frequency range from 30 to 15,000 cps. Harmonic distortion over the same frequency range is less than one per cent.

Operational Adjustment

The operational adjustments are very simple. The desired transfer characteristic should be chosen from Fig. 3. For most applications, compression ratios of 4 to 1 or 5 to 1 are suggested. The threshold control should be set to the maximum clockwise position and a 1000 cps signal of approximately -40 dbm should be applied to the input terminals. The input level control is then adjusted to obtain an output level corresponding to the knee of the desired transfer characteristic. For example, for a 5-to-1 compression ratio, adjust the level to 18-dbm output. Now adjust the threshold control counter-clockwise until a slight reduction in output level is noted. If a gain-reduction meter is con-

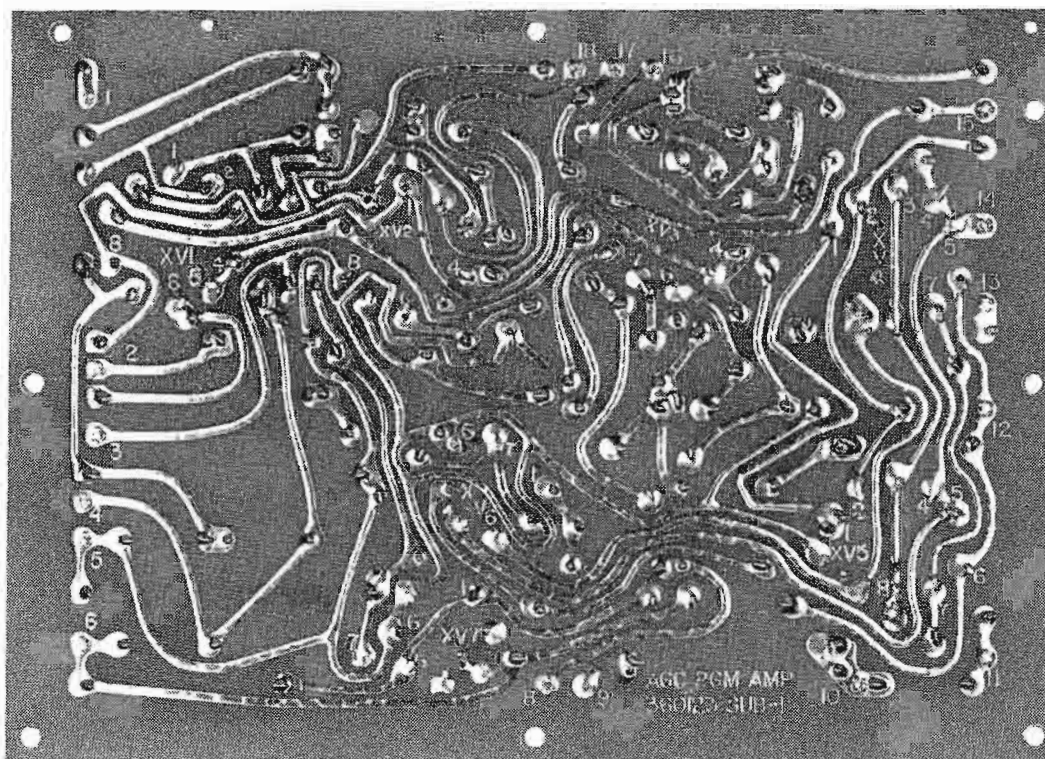

FIG. 6. Use of etched wiring in program amplifier provides greater uniformity of performance.

nected to the amplifier, this meter will start to indicate a gain reduction at this point. The positive delay-bias voltage is thus adjusted to the correct value.

Normal program level is now applied to the input terminals of the amplifier. The input level control is then adjusted until the gain-reduction meter indicates the desired gain reduction or until the desired output level is reached. If there is too much variation in output level for a given range in input level, it may be necessary to increase the input level control setting and to increase the threshold level. If the background noise level should come up too high during low-level passages, the input level control should be set lower.

Conclusion

In many cases a great improvement in system performance may be realized by replacing a fixed gain program amplifier with the BA-25A Automatic Gain Controlled Program Amplifier. It should be noted for example, that the BA-25A requires less rack space than the BA-3A or BA-13A Program Amplifiers, and only slightly more space than the BA-23A Program Amplifier.² The latter has the same type of plug connections as the BA-25A and it is therefore a simple matter to change over if the additional shelf space is available.

² The BA-23A requires 3/10 of a shelf, while the BA-25A requires 1/2 a shelf.

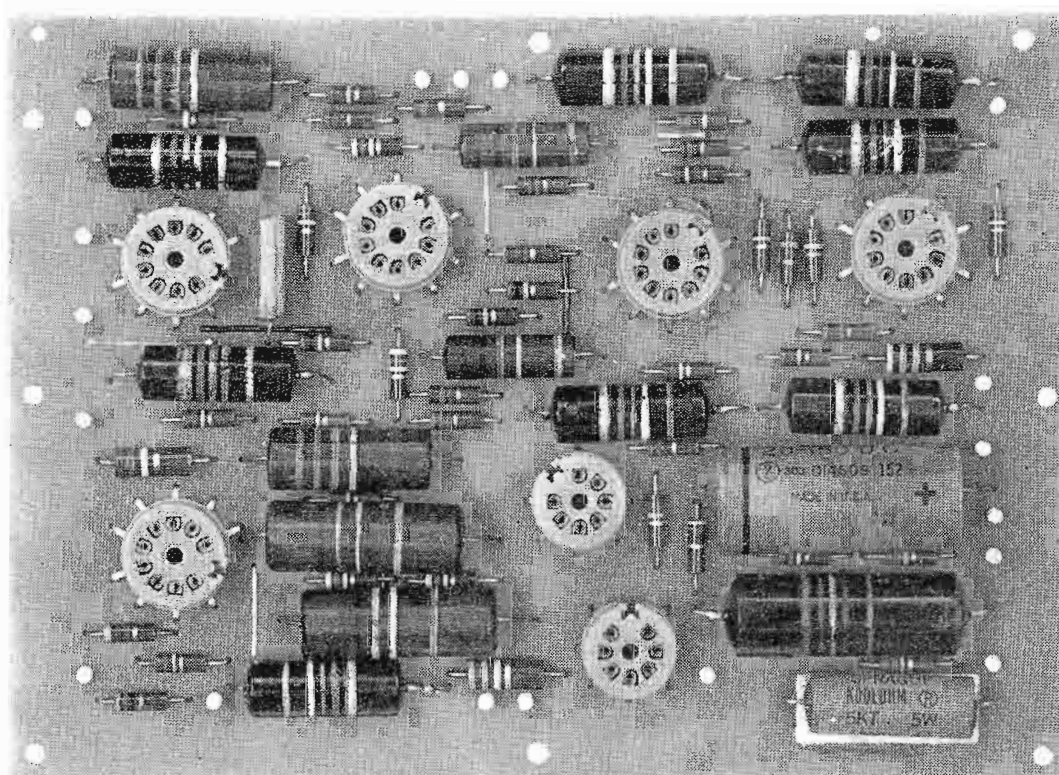
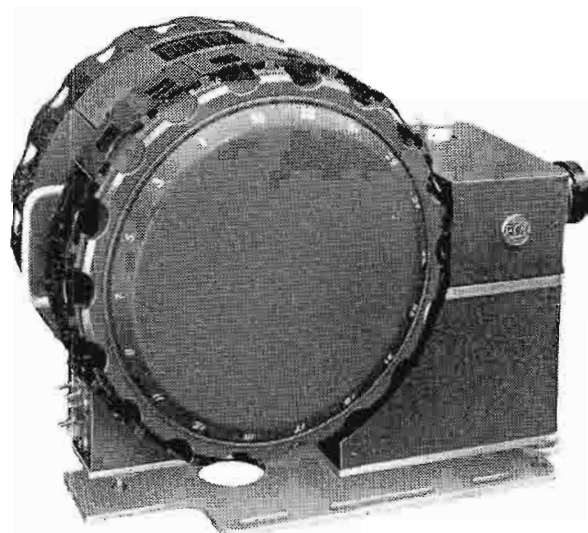
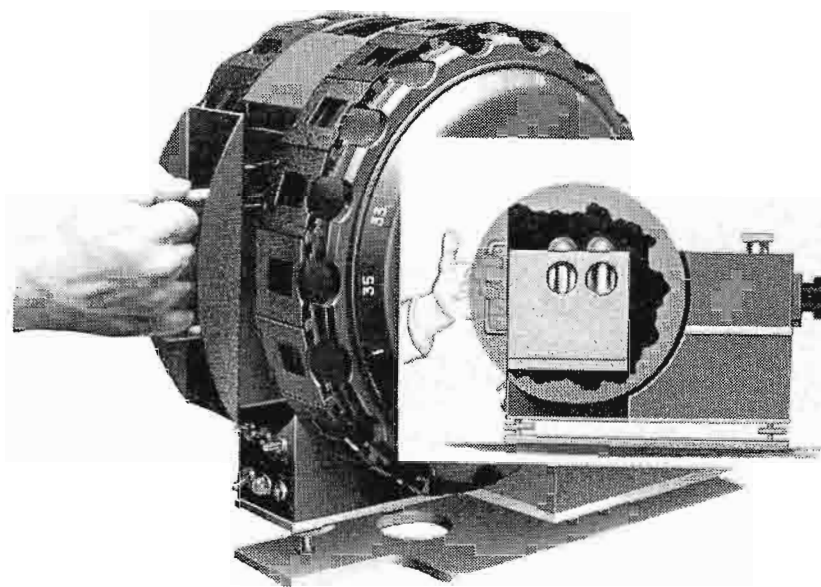

FIG. 7. Arrangement of components on etched wiring board facilitates inspection, identification and replacement.



HIGH CAPACITY



QUICK LAMP CHANGE

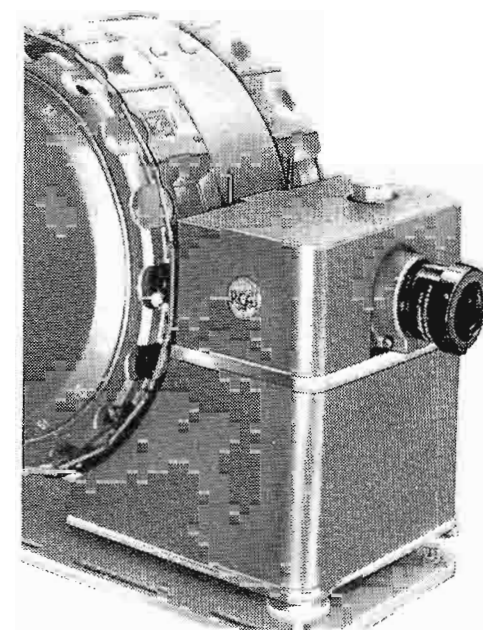

SLIDE CHECK VIEWING

FIG. 1. Advanced features of new TP-7 Slide Projector highlight operating convenience and professional design.

A NEW 2x2 SLIDE PROJECTOR

High Capacity, Loading Ease, Slide Check Viewing, Quick Lamp Change and Precision

Optics are Featured in RCA Slide Projector Designed Especially for TV Requirements

The newest addition to the RCA line of "Professional" film equipment for monochrome and color television is a 2 by 2 Slide Projector, Type TP-7A. This new projector has been designed to the same criteria as other RCA film equipments to provide maximum operational convenience, top quality performance, utmost reliability in day-to-day use, and the latest in professional design features.

The projector is designed around a dual channel optical system which employs a single projection lamp for illumination, and internally multiplexes the two channels into a single projection lens. The slides are placed in holders mounted around the periphery of two rotatable, vertically oriented drums.

Many years of field experience aided by a carefully evaluated field survey of representative TV stations have provided the technical background for the following features of basic importance to the TV broadcaster (see Fig. 1):

1. High Slide Capacity

The TP-7A stores and handles 36 slides, 18 on each drum.

2. Quick Lamp Change

A built-in stand-by lamp can be

quickly placed in operation to minimize lost time due to lamp failure.

3. Easy Loading

The slide holders register the slides precisely and are conveniently accessible around the periphery of the drums. The drums can be rotated manually in either direction at any time except during a slide change cycle.

4. Slide Check Viewing

Rear illumination of slides around the drums is provided for ready visual checking.

5. Rapid Slide Sequencing

Slides can be shown at a rate of approximately one per second.

6. Slide-to-Slide Fast Dissolve

The transition from one slide to another is accomplished in approximately 1/5 second.

7. Durability

Rugged construction and optical rigidity are provided by the use of castings. Long life is assured by extensive use of ball bearings and nylon for wear surfaces.

8. Accessibility

Optical surfaces are readily acces-

sible for cleaning without the use of tools. Projection lamps can be readily replaced.

9. Versatile Control

Remote and/or local control of drum operation in forward or reverse directions as well as holding either drum while advancing the other is provided.

10. High Quality Optics

The single light source and front surface mirrors, which are used throughout, assure color balance between channels. The slide illumination reaches a new high in uniformity.

11. Interchangeability

Compact design permits the TP-7A to be installed and used with all RCA vidicon film equipment systems.

Versatile System Applications

The TP-7A Slide Projector has been designed to fit into the same space occupied by TP-3 Series slide projectors previously sold by RCA for vidicon camera systems. The TP-7A increases the slide handling capacity of a film system from 12 to 36 with no increase in space requirements.

A series of lenses is available for use with the TP-7A to provide proper magnification

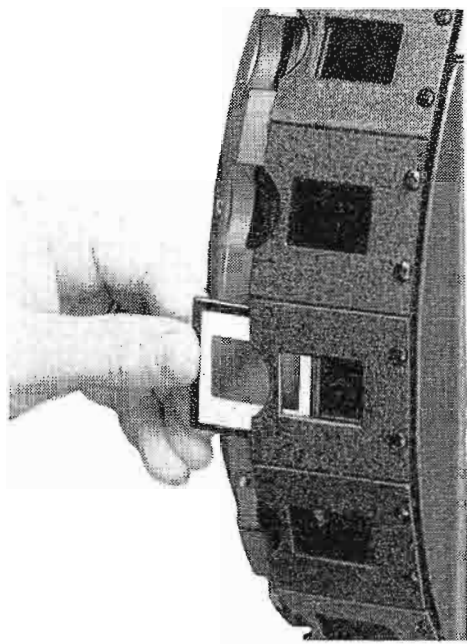

LOADING EASE

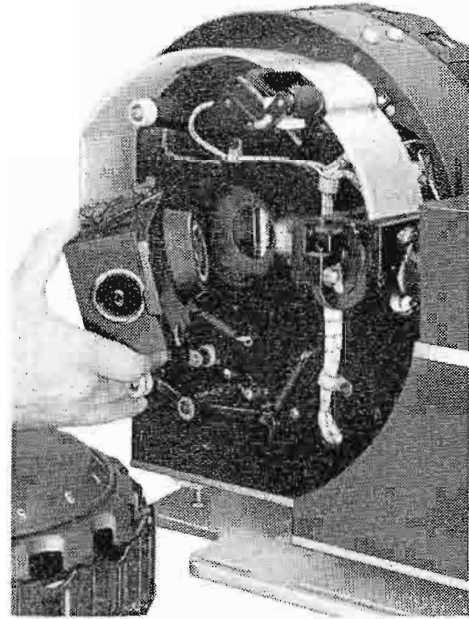

UNITIZED CONSTRUCTION

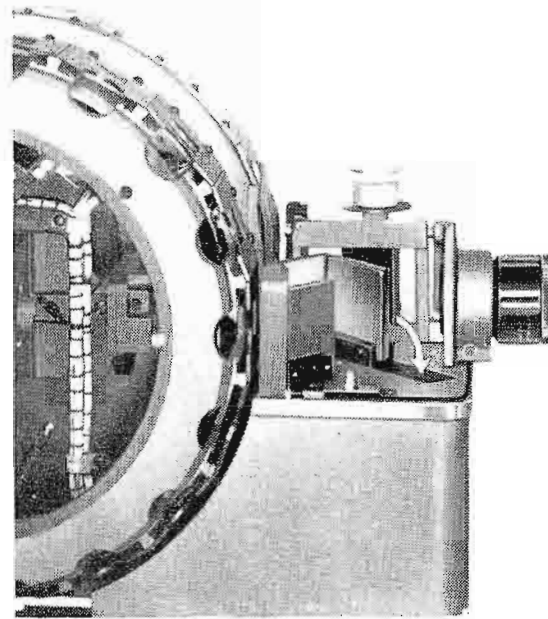

INSTANTANEOUS SLIDE CHANGE

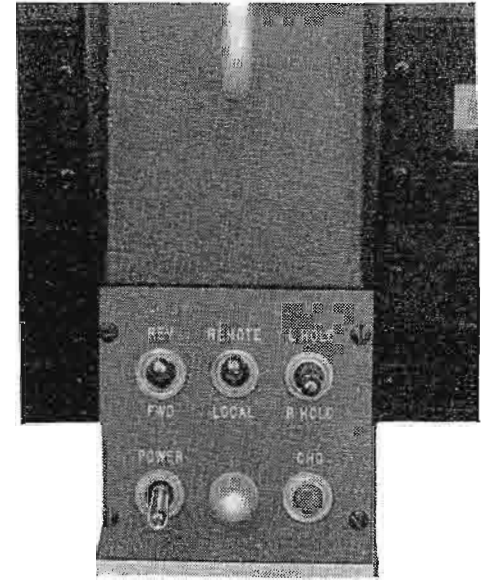

VERSATILITY OF CONTROL

FOR TELEVISION

by A. E. JACKSON,
R. D. HOUCK, and
R. F. ROUNDY,
*RCA Broadcast and Television
Equipment Department*

and throw distance for integration into any of RCA's three multiplexed film systems.

When the TP-7A is used to replace an existing unit on the TP-11 Multiplexer a seven and one-half inch projection lens is used. The TP-7A mounts on the same projector supporting shelf and utilizes the existing mounting holes. A control box which houses the relays, capacitors, etc., associated with the control circuits is approximately the same physical size as the control box on the earlier projector and may mount in the same location.

The seven and one-half inch projection lens is also used when the projector is installed in the TP-15 Multiplexer system. The TP-7A will mount on either the 1-V Pedestal and slide projector shelf or on the periscope cover utilizing existing mounting holes. (See Figs. 2 and 3.) A nine-inch lens is available for special applications with the TP-15 Multiplexer where TP-16 projectors are used. The control box will mount in the base of the 1-V Pedestal in the same space as the previous control box.

Where the TP-7A is to be used with TP-12 Multiplexers a seven inch projection lens is available. In this case the slide projector will mount on the end of the slide projector shelf and mounting holes

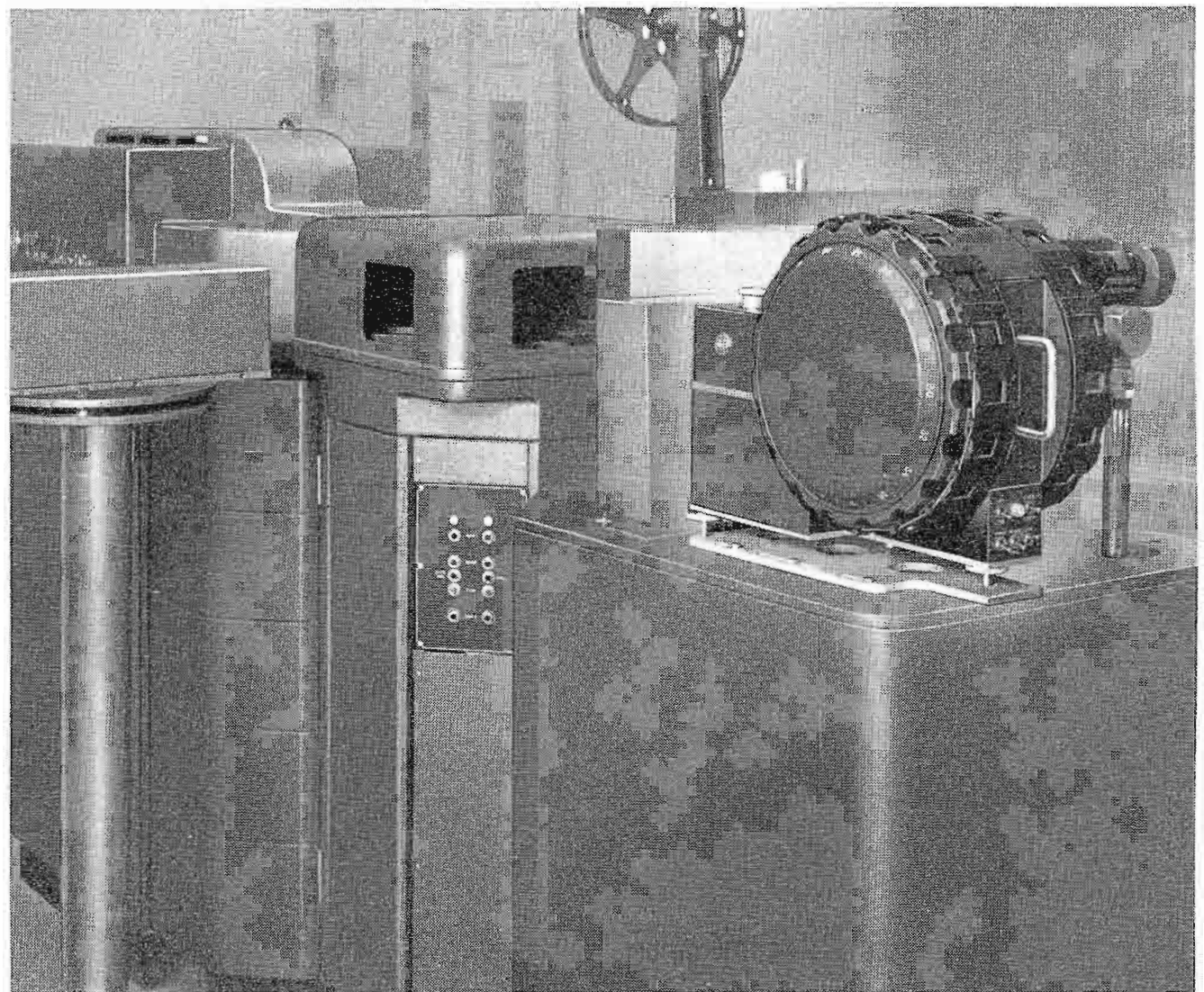

FIG. 2. TP-7 Slide Projector installed in a 3-V color film system utilizing a TP-15 Multiplexer. The slide projector has been designed to fit into any RCA vidicon film camera system.

will have to be provided. By moving the projector back in this fashion it alleviates the congested condition now existing in systems where the neutral density light control is used.

The TP-7A utilizes 24 volts dc in its control circuits. Existing 24-volt supplies now being used with the slide projector will handle the requirements of this slide projector.

Internally Multiplexed Optical System

The optical system used in the TP-7A is shown in Fig. 4. A single projection lamp is used to illuminate two optical channels. A combination of front surface mirrors multiplex these two channels through a single projection lens so that a slide in either channel may be projected on demand. A moving mirror in the multiplexing system is utilized to accomplish this changeover.

The projection lamp is positioned with its filament plane coincident with the projection lens axis. Symmetrically located on each side of the projection lamp are con-

denser lenses. These collect the light from both sides of the lamp filament to form two beams going in opposite directions. Front surface mirrors fold the light beams to direct them parallel to and equidistant from the projection lens axis. A second pair of lenses in each channel relay the light beams to the slide gate positions. These positions are immediately in front of the fourth lens element.

In the right-hand channel, two fixed front surface mirrors located immediately in front of the slide gate position are arranged to periscope the optical path to the center of the projector, where it coincides with the axis of the centrally located projection lens. Hence, the slide in the right-hand channel is projected whenever the projection lamp is on, unless its optical path is blocked by some means.

The means of blocking this path is provided by using a moving mirror as one component of the two-mirror periscope arrangement used to fold the left channel optical path to coincide with the axis of centrally located projection lens. The mirrors forming the periscope for the left

channel are located forward of those in the right channel. The mirror located on the central axis is mounted on a pivot so that it may be rotated in or out of the optical path. When it is in the optical path, the left side periscope is complete.

Light from the left channel reaches the projection lens and the slide in this channel will be projected. At the same time the opaque back of the mirror blocks off all light from the right channel. As the mirror is moved out of the optical paths, with a motion parallel to the plane of its reflective surface, some of the light from the left channel falls off the edge of the mirror and does not reach the projection lens. However, part of the right channel optical path is no longer blocked so that the same proportion of light lost in the left channel now reaches the lens from the right channel. In effect, this offers a lap dissolve type of transition. Because of the physical location of the mirror with respect to the projection lens and slide, this lap dissolve is of the localized area type, which begins at one edge of the image and wipes rapidly across to the other edge to complete the transition. Black opaque surfaces are utilized on

FIG. 3. Another example of versatile systems applications of the TP-7 Slide Projector. Here it is used with the periscope attachment of the TP-15 Multiplexer.

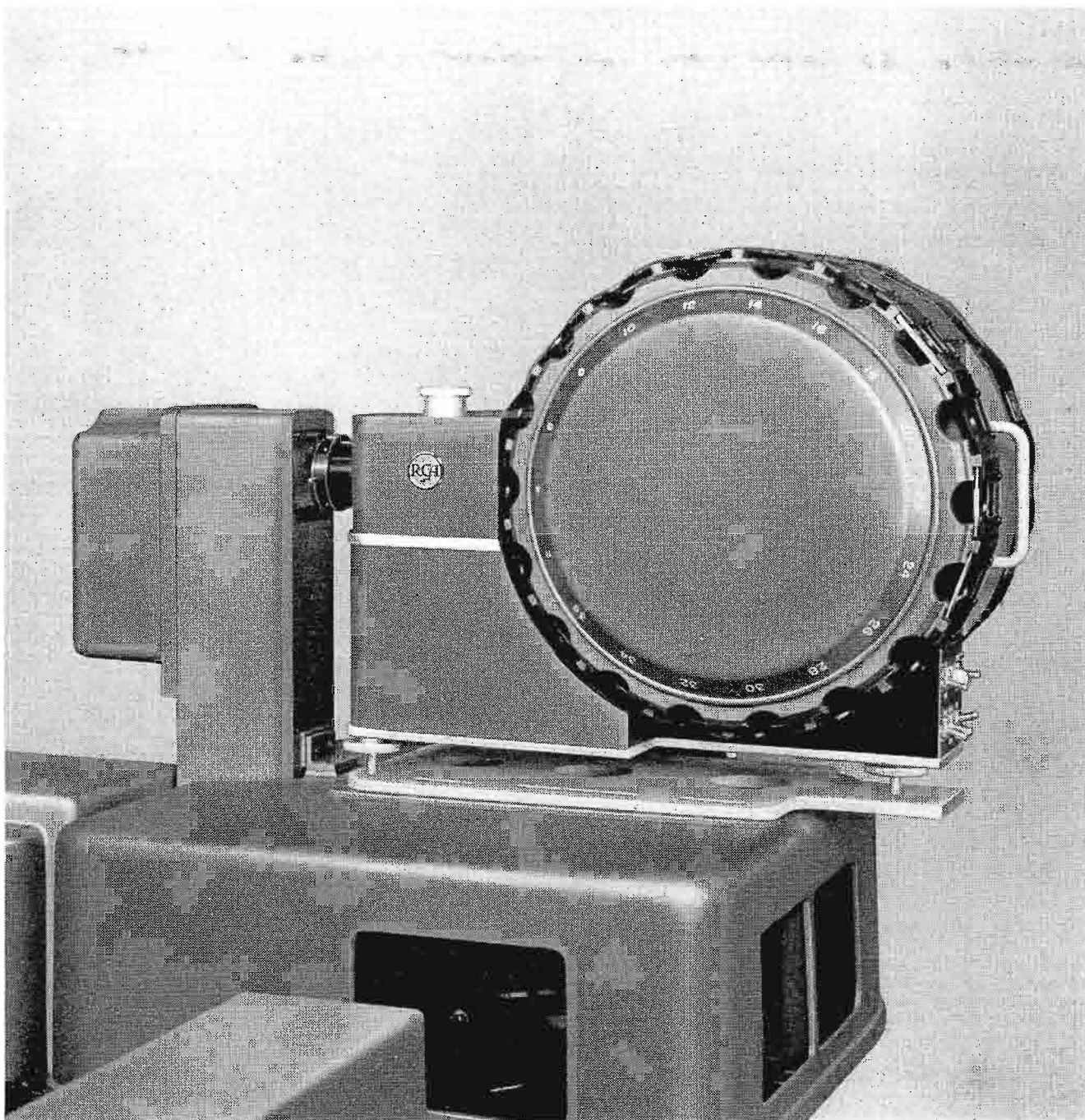

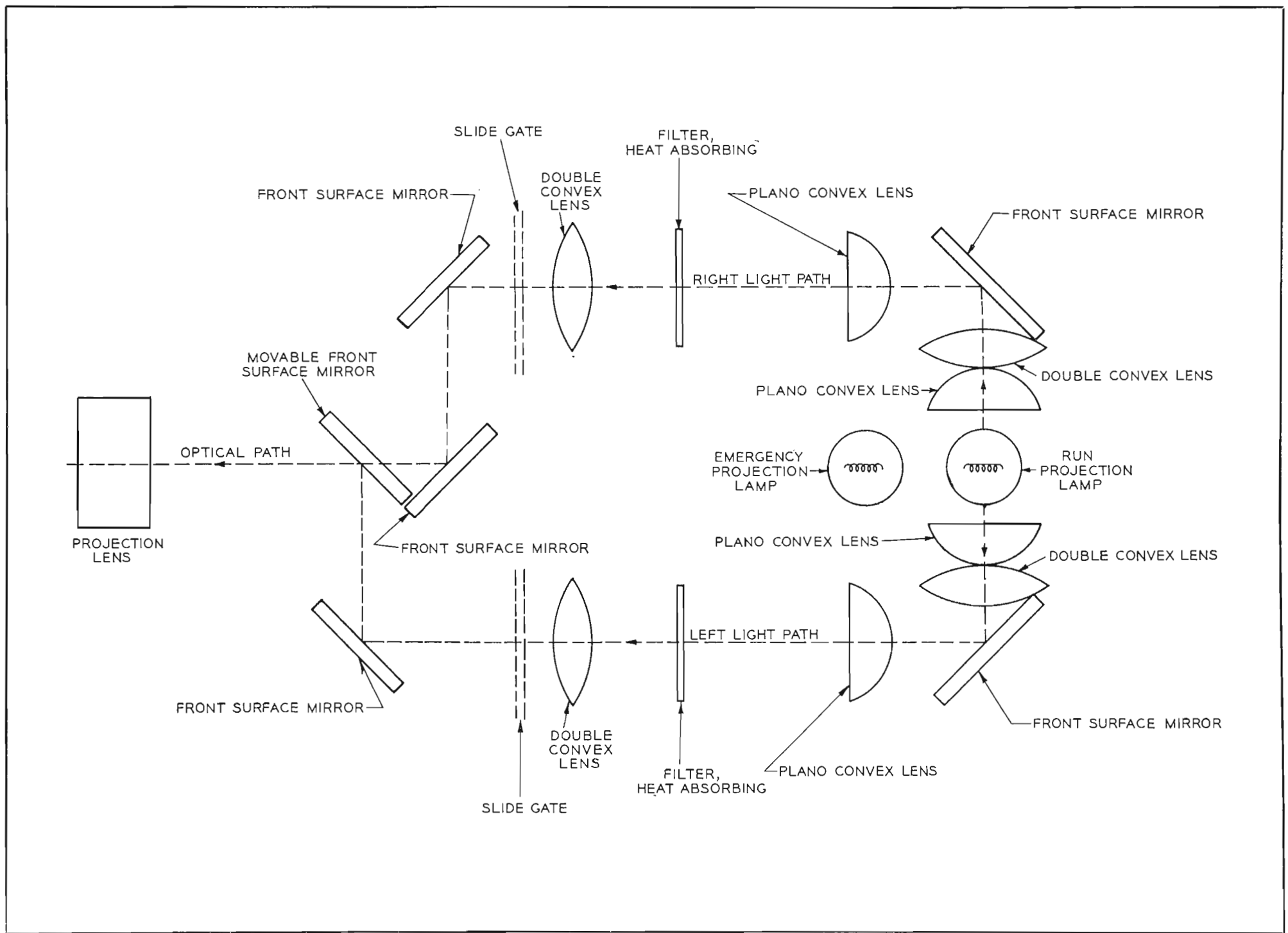

FIG. 4. Optical system employed by the new slide projector. Single lamp source shown here eliminates color balance problems. Highest quality optics are used throughout.

the back of the moving mirror and inside the covers to absorb the light from the channel not being projected.

An infrared filter is inserted in each optical channel between the third and fourth condenser lens elements. It absorbs much of the heat in the light beam so that slides may be projected for extended periods without overheating. The filter has been selected to give a color temperature match with other RCA motion-picture projectors which may be used in the same color film chain.

Matched-Channel Optical Performance

The two optical channels are essentially identical thus making smooth programming continuity possible by sequential operation. During the "show" period of one channel the slide in the other one can be changed and that channel readied for the next slide "showing."

The use of fully reflective front surface mirrors throughout both optical channels

and the use of only one projection lamp are highly advantageous design choices from the point of view of source color temperature match between the two channels. The standard projection lamp is a 300-watt medium prefocused base type which provides approximately 450 foot candles illumination incident on a 3.35 by 4.46 inch screen. This is ample light for RCA 3-Vidicon Color Film Cameras. Should additional light be required a 500-watt lamp can be used. The cooling system is adequate, even with the 500-watt lamp, to keep the temperature rise of slides in the gate to a safe amount.

The uniformity of illumination is excellent. The brightness of a 3.35 by 4.46 inch image area is not less than 90 per cent of maximum at any point in this area when the illuminated field at the projector gate is the transmitted picture area size specified in ASA PH 22.94—1954 and the measurement is made in accordance with ASA PH 22.91—1955, Par 8.3.3.

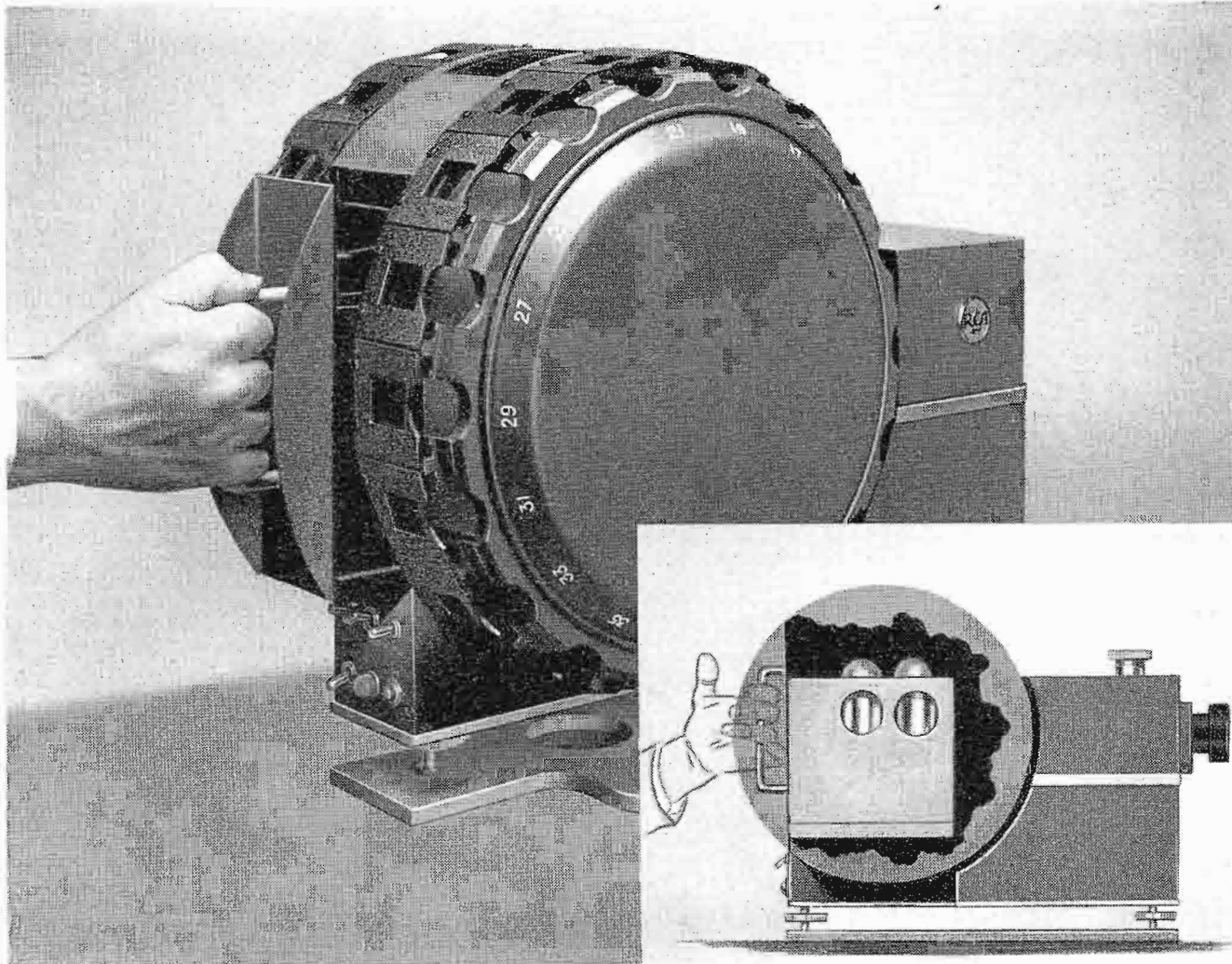

FIG. 5. One of the "professional" features of the projector is quick lamp change. The emergency lamp is manually moved into operating position in case of lamp failure.

Emergency Projection Lamp

A "Professional" feature of the projector is a spare projection lamp position. In case of failure of the regular lamp during a show, the stand-by lamp may be quickly moved into operating position. The RCA film projectors have been equipped with a similar feature for several years. It has proved to be of unquestionable merit. (See Fig. 5.)

The quick change is achieved manually. Two lamp sockets are attached to a sliding drawer type lamphouse. When the drawer is in the forward position, the regular projection lamp is in position to operate. By pulling back on the lamphouse handle, the drawer is moved backward to bring the "emergency" lamp into projection position. A sensing switch associated with the lamphouse position keeps the proper lamp socket energized. The drawer is held against the positioning stops by the use of spring loaded rollers.

A spring type catch serves as a positioning stop for the lamphouse in the rear or emergency position. To replace lamps this catch may be disengaged by depressing it and the lamphouse withdrawn farther to provide access to both lamps. (See Fig. 6.) A final stop is used to prevent accidentally withdrawing the drawer all the way, when replacing lamps.

When the lamphouse is in the emergency position, its out-of-place appearance is

immediate indication of an emergency change. This serves to remind the operator that an emergency change has been made, and that the burned out lamp needs replacement. After making this replacement, the lamphouse may be returned to its original position.

FIG. 6. Easy access is allowed to both projection and emergency lamps for replacement. A final stop is used so that the drawer may not be accidentally withdrawn.

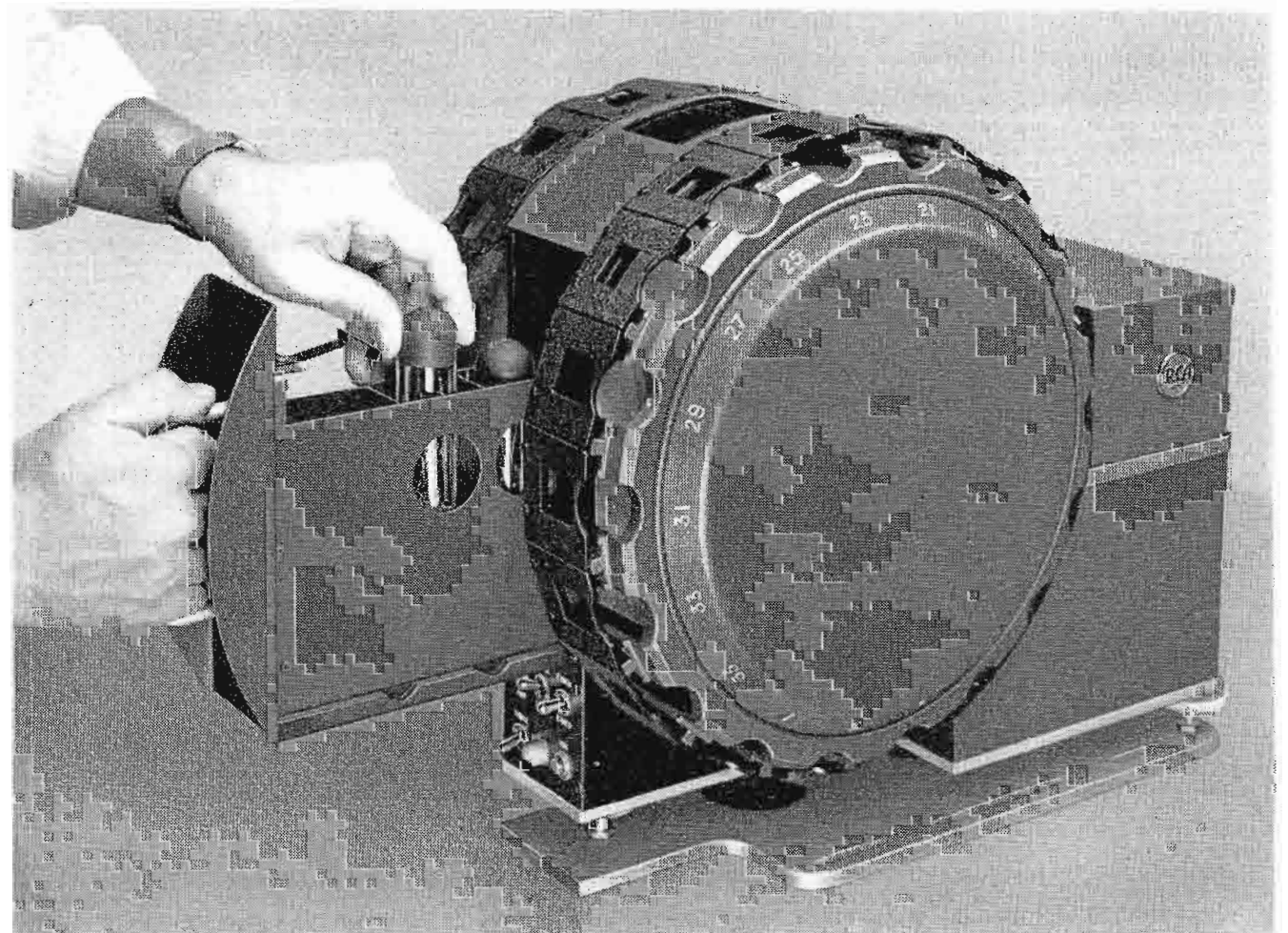

Moving Mirror Mechanism

The manner and speed of mirror motion required to provide the illusion of instantaneous slide-to-slide switch were important factors in determining the design of the mirror moving mechanism. As noted previously, the moving mirror is located at the intersection of the two optical channels and moving the mirror in a plane parallel to its reflective surface gives a wipe type of lap dissolve transition. (See Fig. 7.) In operation this transition takes place in less than 1/5 second, providing a very acceptable illusion of instantaneous switching.

A reversible shaded pole gear-head motor coupled to the mirror through a restricted type of geneva movement provides the means for rapid movement of the mirror into and out of the optical paths. The mirror and its mount are pivoted on a shaft which is perpendicular to the reflective surface. This permits mirror motion only in the plane established by this surface. Proportions are such that the mirror and its mount traverse an arc roughly equivalent to one station of a five station external geneva mechanism. The pin wheel is reduced to a simple crank and pin and is coupled to the drive motor through a friction clutch. The crank travel is limited in both directions by stops. The friction clutch reduces inertia shock on the motor gear train when the crank strikes its limit stops. Lever type sensing switches are operated by the crank near each end of its

FIG. 7. Moving mirror mechanism operates by means of a geneva movement; assures instantaneous slide-to-slide transition.

travel. The crank is detented in these positions to prevent spring back when the motor is de-energized and to maintain proper pressure on the sensing switches.

Actual mirror motion is less than 1/5 second, yet the comparatively gentle accelerating and decelerating forces inherent in this type of mechanism gives smooth, quiet operation.

Easy-Loading Slide-Handling Drums

Two drums mounted with their rotational axis in a horizontal plane provide a total capacity of 36 slides . . . sufficient to handle most broadcasting needs. Individual slide-holding wells located around the periphery of the drum are easily loaded by inserting slides in the well openings facing the exposed end of the drums. (See Fig. 8.) This permits access to all slide positions at all times for loading and unloading.

Slides are located by accurate machining of three surfaces on each slide well recess. In this manner it is possible to attain any degree of registry desired by controlling the location of the picture area with respect to the reference edges when the slide is being prepared. One of these surfaces locates the bottom edge of the slide to provide vertical positioning. One locates a vertical edge of the slide to provide horizontal positioning and the third surface locates the face of the slide to provide focal plane positioning. One drum on the projector is machined opposite hand so that the slides in both channels will be registered from their bottom edge.

A cover plate for each slide position has three finger springs which maintain the slide against the focal plane registration surface and vertical registration surface. The friction created by the spring pressure on these two surfaces maintains slide contact with the horizontal registration surface. The cover plates that support the springs have a masking aperture that roughly trims the projectable picture area to the 3 by 4 aspect ratio required by television. Finger room is provided at the slide wells to permit grasping the slides by the edge for unloading.

FIG. 8. Individual slide-holding wells are located around the periphery of the dual drums. These permit access to all slide positions for easy loading and unloading.

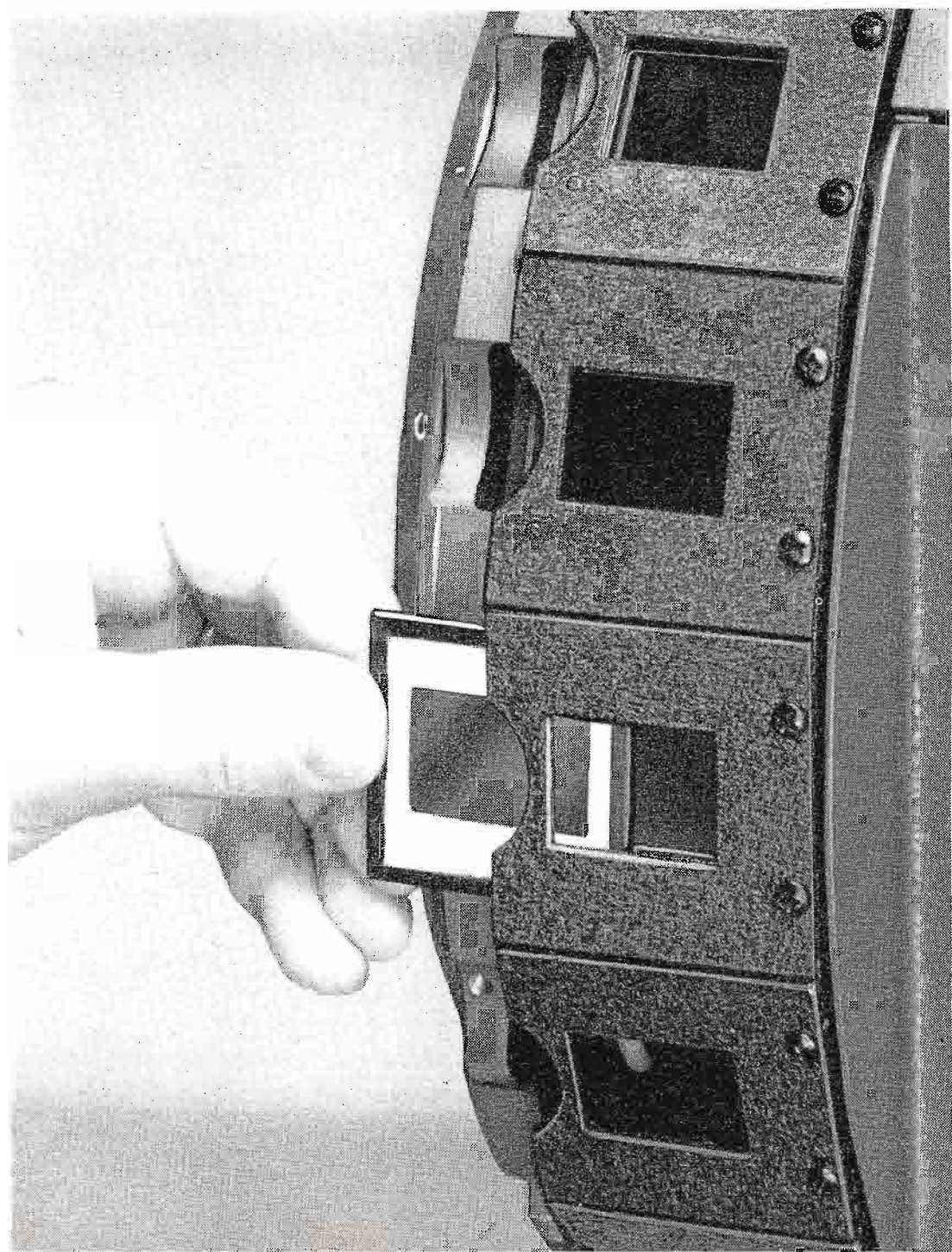
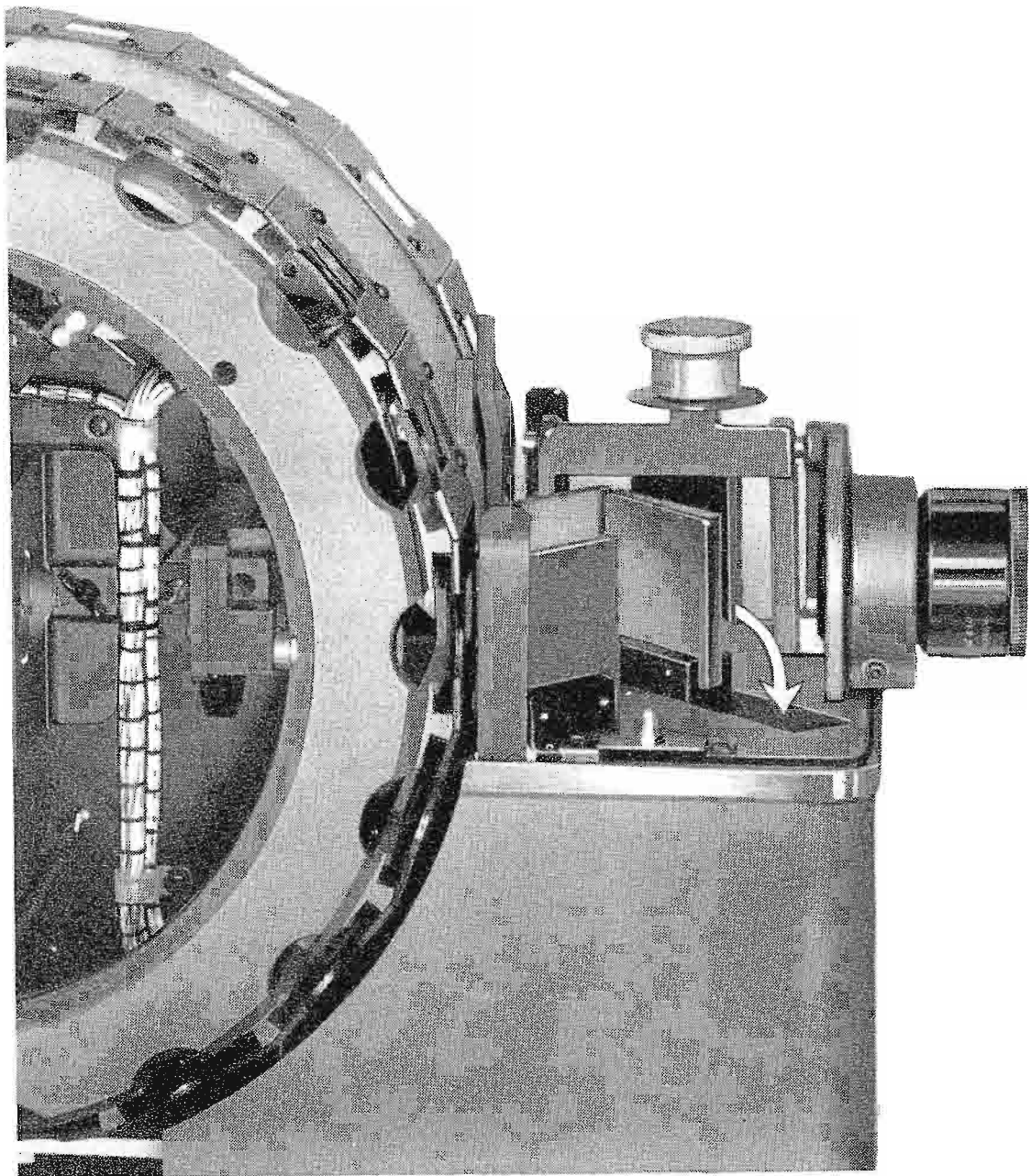

FIG. 10. Internal view of a single drum showing indented slots used to advance the drum.

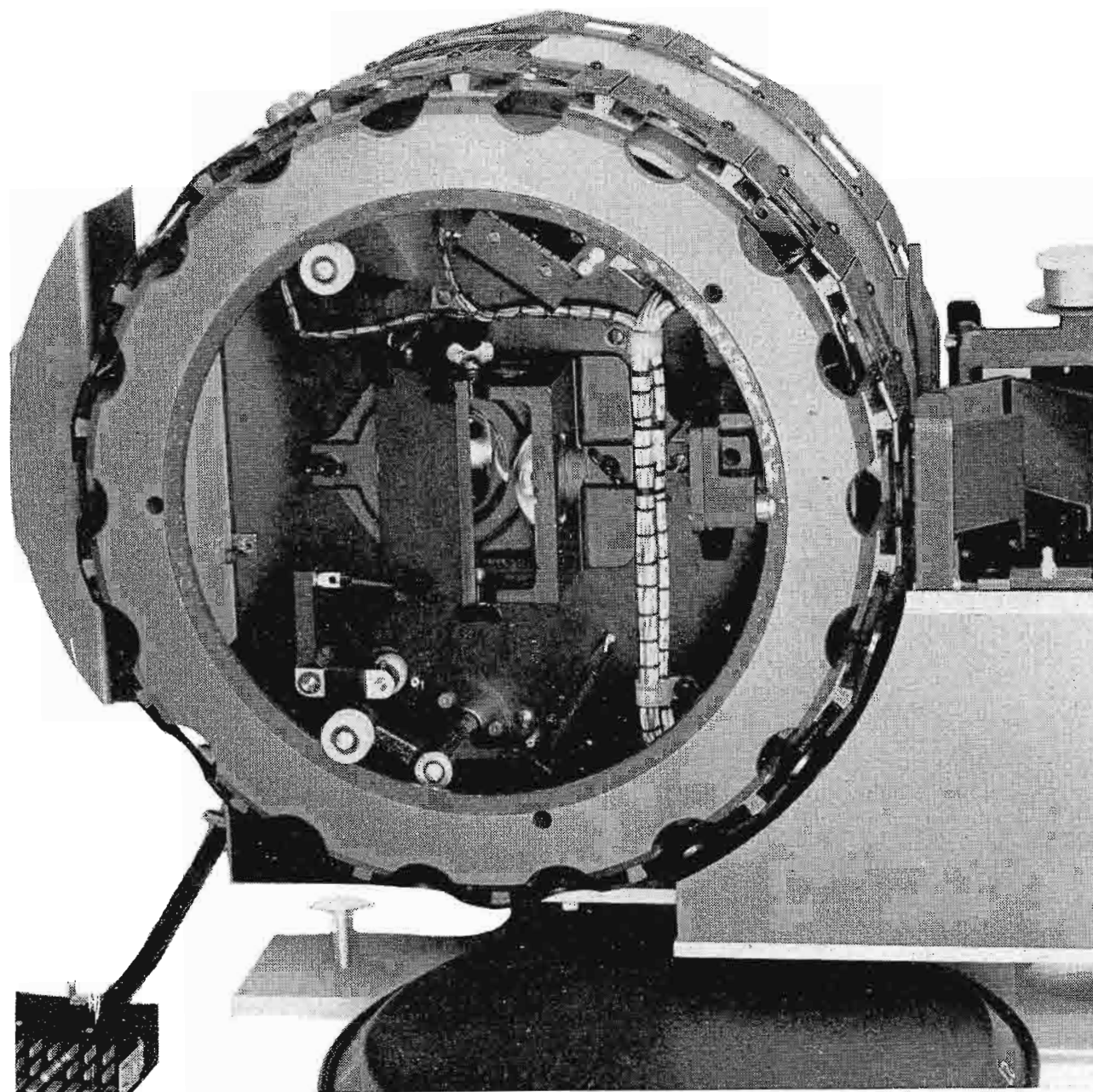
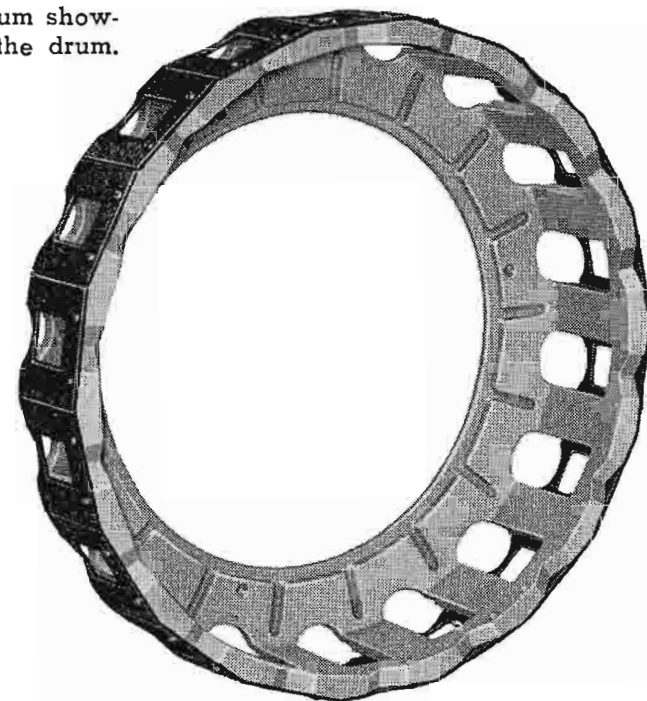

FIG. 9. TP-7 Slide Projector with drum cover removed. Note split V rollers which straddle the run of the drum flange to provide lateral positioning.

Drum Support and Registration of Slide Positions

The drums are supported in a unique arrangement which offers easy access to optical components for cleaning. An internal flange at one end of the drum casting provides a support rim of large internal diameter. Three sets of rollers equally spaced around its circumference engage the rim in a manner to provide support and rotational freedom. Two of these roller sets are split V type. (See Fig. 9.) They straddle the rim of the drum flange and provide lateral positioning. One set of these V rollers is mounted on a spring loaded arm to eliminate axial and radial play.

The third set of rollers, located near the gate, is used for accurate positioning and registration. Their centers are located in the horizontal plane passing through the center of the slide show position. This set of rollers consists of two ball bearings having their center lines perpendicular to each other. The outer race of one of these bearings rides against the internal circumfer-

ence of the drum flange and the inner race against the face of the flange.

The bearing that contacts the internal circumference of the flange provides longitudinal positioning. The focal plane reference surfaces of the slide holding recesses are accurately machined with respect to this circumference, so that this bearing becomes the means of maintaining accurate focal registry between slide positions. The spring loaded V roller arm provides proper pressure to maintain constant contact between the bearing and the flange.

Another bearing in this set operates against the flange face to provide lateral positioning with respect to the optical axis. The horizontal reference surfaces of the slide holding recesses on the drums are machined accurately with respect to this surface, so that horizontal registry between slides is accurately maintained. The drum flange is kept in contact with this bearing by the pressure of the large spring loaded nylon roller riding on the back edge of the drum. (See Fig. 10.)

Rotational positioning to provide vertical registry between slide positions is accomplished through a series of detent notches on the back edge of the drum. There is a notch for each slide position. A spring loaded nylon roller acts as a detent in these notches. Angle of detent notches and spring tension is such that once the roller enters the notch, it will drive the drum until firm seating occurs.

In addition to the registry of slide positions, registration between drums is also provided. Minor adjustments of one drum location permit alignment with a fixed drum. Horizontal alignment is accomplished by moving the side drum support bearing with respect to the vertical side plate. Correction for focal plane alignment is accomplished by adjusting the inner drum support bearing. Spring loading of the drums against these bearings eliminates play which might be introduced by change in position. Correction for vertical registry is accomplished by raising or lowering the pivot shaft of the roller arm.

Drum Drive Mechanisms

Each drum has its own drive mechanism based on the internal geneva principal. Reversible, shaded pole, gear head motors are used. Each motor is coupled through a ball bearing supported shaft to a crank arm. A nylon roller on the crank pin engages slots cast on the inside face of the drum flange. (See Fig. 10.) One revolution of the crank advances the drum one slide position. The lock commonly associated with such geneva movements has been eliminated so that the drum moves freely when the pin is not engaged in the slide. This permits manual rotation of the drums at any time, except during the actual power change cycle, and also aids in accurate rotational positioning of the drum. In operation, the drive mechanism moves the drum and roughly positions it at the next slide position. The detent linkage then takes over and accurately positions the drum to provide vertical registry.

Background Illumination for Viewing Slides

A translucent plexiglass shield in close proximity to the internal diameter of the drum collects and diffuses the spill-over light from the main optical system to provide a softly illuminated background for the slides. (See Fig. 11.) This permits visual observation of picture area when loading the slides. It also permits visual checks on orientation, loading sequence, etc. of the slides at any time without removing them from the drum. Since the drums may be readily rotated by hand, a complete check on every slide in the drum can be accomplished quickly.

Basic Construction

The basic framework of the projector has been designed to provide rigid support for all components and at the same time permit good accessibility for maintenance and servicing. Two parallel vertical plates attached to a horizontal bottom plate form the basic framework of the projector. The space between these vertical plates houses the lamphouse drawer, the drum drive motors and the control panel. The condenser system, drum supports and drum drive mechanism are mounted on the outside of these plates. A plate type casting near the front of the projector forms a horizontal table to support the mirror multiplex system, the projection lens mount and the drum detent arms.

Covers are provided for each of the three major compartments thus formed. These covers are made of steel to provide magnetic isolation of the motor fields in addition to their individual shields.

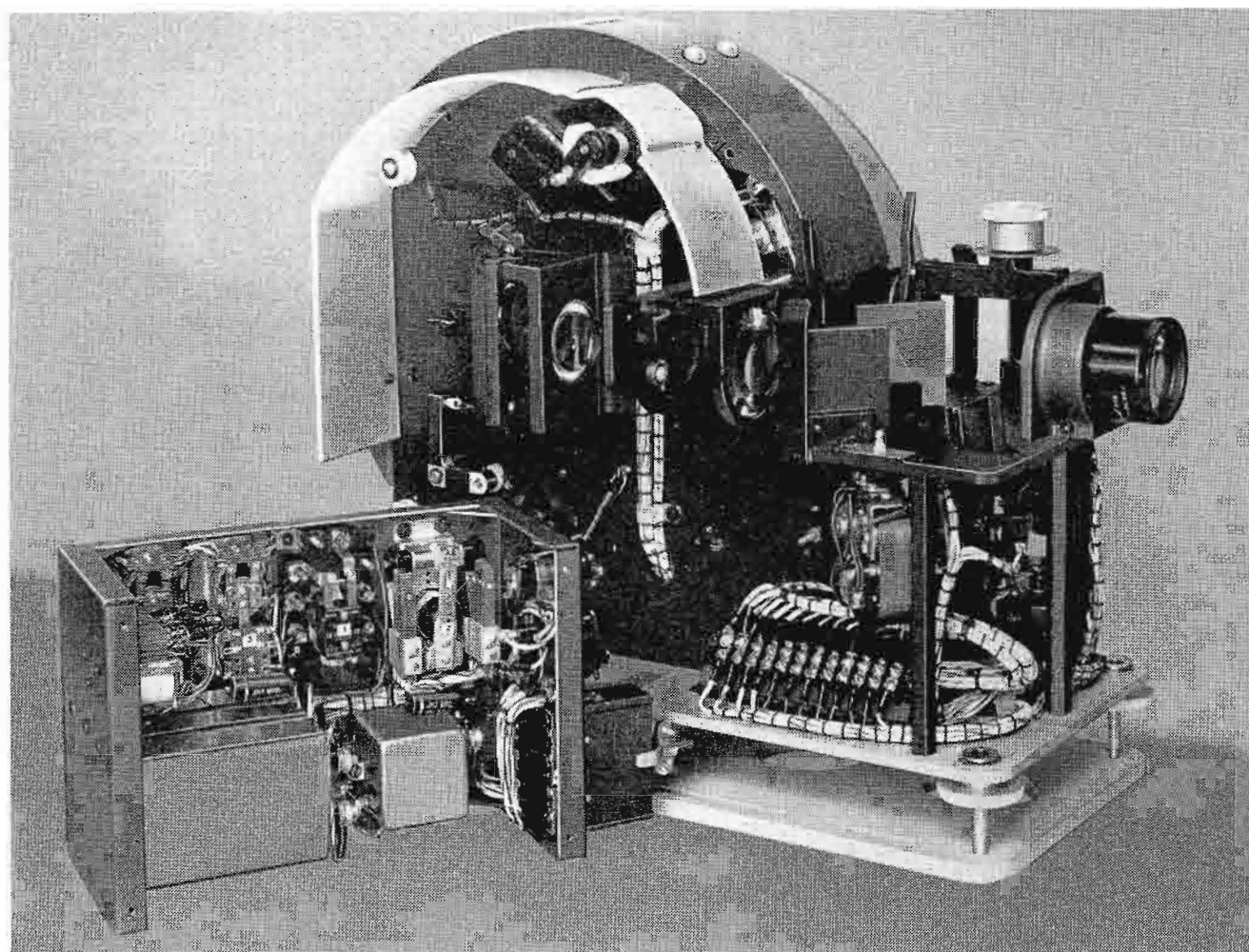

FIG. 11. A plexiglass shield in close proximity to the internal diameter of the drum collects spill-over light to provide slide check viewing.

Condenser Lens Mounts

Castings provide sturdy mounts for the condenser system elements. One casting holds the three rear lens elements and the beam folding mirror. Another holds the front element and heat filter. This front casting is also used to mount the front set of drum support rollers. Two dowel pins

in the side plates locate and support each casting. Three pads contact the side plates to provide stability. Wing screws operating in the hollow dowel pins clamp the castings against the side plates to give the measure of rigidity and alignment accuracy desired yet permit easy removal for cleaning without the use of tools. (See Fig. 12.)

FIG. 12. Drums, drum covers and optical assemblies are easily accessible for cleaning. Projector can be kept dust free with minimum effort.

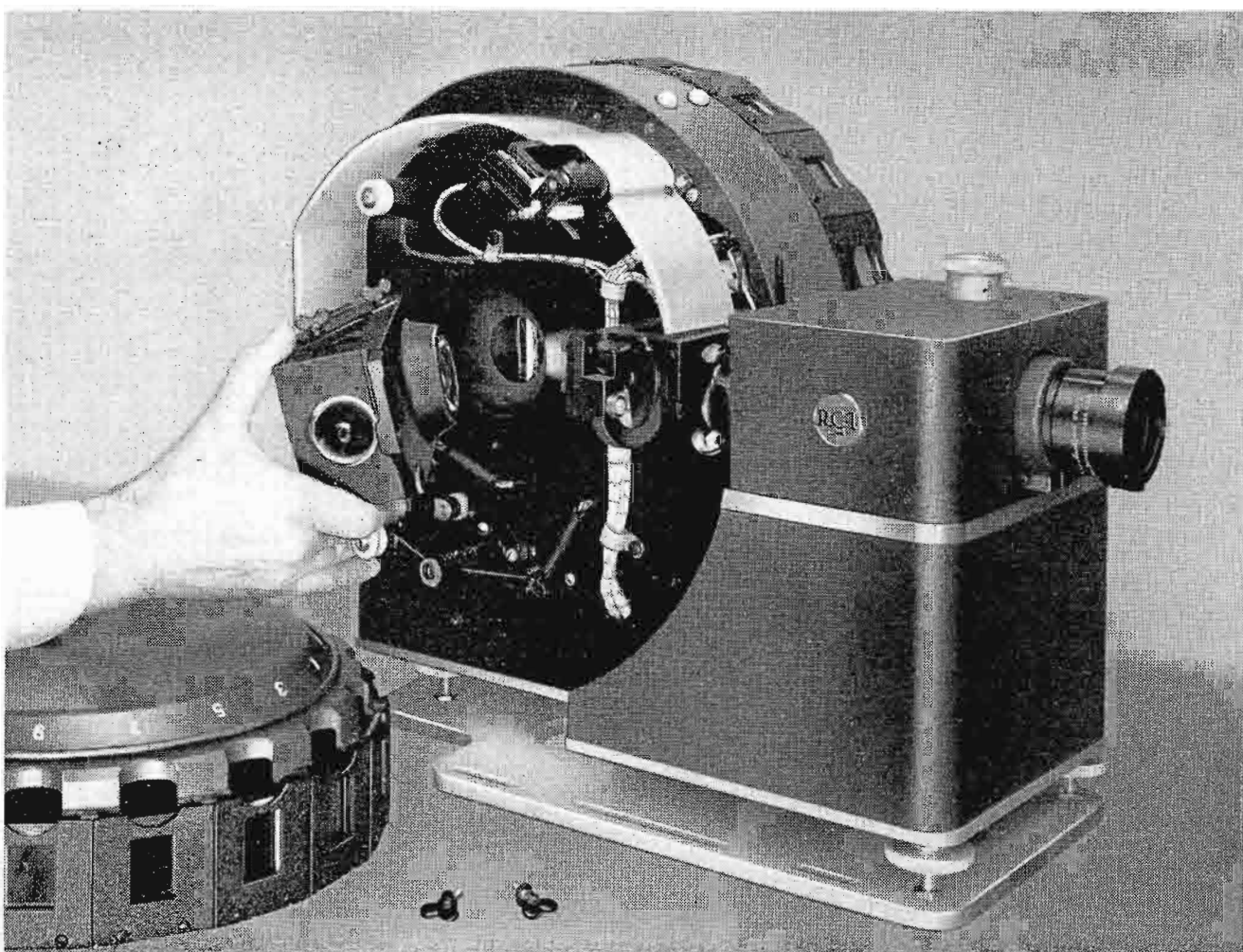

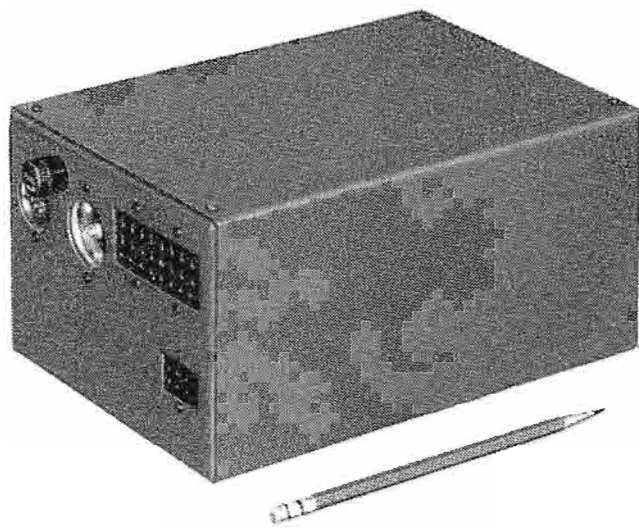

FIG. 13. Compact auxiliary control box houses all relays, drum and mirror motor capacitors.

Projection Lens Mount

The projection lens is clamped in a split mount. This mount is supported by a sliding shaft at the top. A surface near the bottom contacts a guide surface on the optics plate casting. Spring loading the mount against this guide surface provides the required stability. A rack and pinion arrangement links the sliding shaft to an external focus knob above the front cover. External iris diaphragms are available for attaching to the three lenses previously mentioned. These iris diaphragms are used when aligning the projector in TV film chains which utilize field lenses.

Cooling

A centrifugal type blower is located in the compartment beneath the optics plate casting. Ball bearings are used in this blower to provide long life. Air intake to the compartment is from openings near the slide show positions and an auxiliary opening in the bottom plate. Obtaining a portion of the cooling air from near the slide show position creates a slight air turbulence on the face of the slides which aids in keeping them cool.

The output of the blower is directed through a duct to the bottom of the lamp-house drawer where it flows over the lamp envelope and out a gridded opening in the top cover.

Projector Leveling

Height and leveling adjustments are accomplished by three leveling knobs which adjust the length of three supporting legs separating the main body of the projector from a base plate. The base plate has slots for hold-down bolts to clamp the projector to its supporting shelf or table. Distance from the base plate to the optical axis is adjustable between $9\frac{1}{4}$ and $10\frac{3}{4}$ inches.

Accessibility for Maintenance and Service

Easy accessibility for cleaning of optics is a feature of this design. The top front cover which protects the multiplexer mirrors from dust is held in position by two

spring latches. It may be removed by lifting straight up, thus giving access to all optical components on the optical plate. For access to the condenser optics the drum covers or drums must be removed. Removal of the entire drum assembly is readily accomplished by depressing the spring loaded drum support arm sufficiently to disengage the V rollers from the drum flange, then lifting the drum off the front roller supports. Further access for service requires simple tools. The top curved cover and bottom front cover are held on with screws. The lamp-house drawer is retained by one stop screw. With the removal of these items, almost every component in the projector is accessible for servicing.

Control Box

The auxiliary box (see Fig. 13), containing all the relays, the drum and mirror motor capacitors, may be mounted in a small space. A cover which lifts off with the removal of four screws permits access when fastened to a standard bathtub chassis in the base of the TP-15 Slide Projector pedestal. All electrical connections to the box are of the plug-in type. One jack connects to the slide projector, two jacks connect to the power required (115 volt ac and 24 volt dc) and the remaining two jacks furnish connection for full remote control.

Versatile Operation

Operation of the projector in a straight sequential fashion is accomplished literally "at the touch of a button." By actuating the slide change push button the projector is caused first to project a new slide from one drum, and then to advance the alternate drum forward to its next slide position. The entire sequence is completed in less than one second allowing a slide change rate, if desired, of approximately one per second. In addition to "normal" operation two "special" operating modes are available which may be used separately or in conjunction with each other. Since the drive mechanism is designed to work equally well in either direction it is possible to simply REVERSE the rotation of the drum drive motors and project the slides in reverse sequence. Also, it is possible to HOLD either drum so as to project a given slide in that drum alternately with two or more slides in the other drum. These special operating features may be combined so as to advance forward through a series of slides to a given point and then return slide-by-slide to the starting point: 1-2-3-4-3-2-1.

Foolproof Operation

In order to guard against the possibilities of faulty operation a number of interlock-

FIG. 14. All electrical controls are located at the rear of the projector. Panel includes Forward, Reverse, Hold, Power, and Change controls for completely versatile operation.

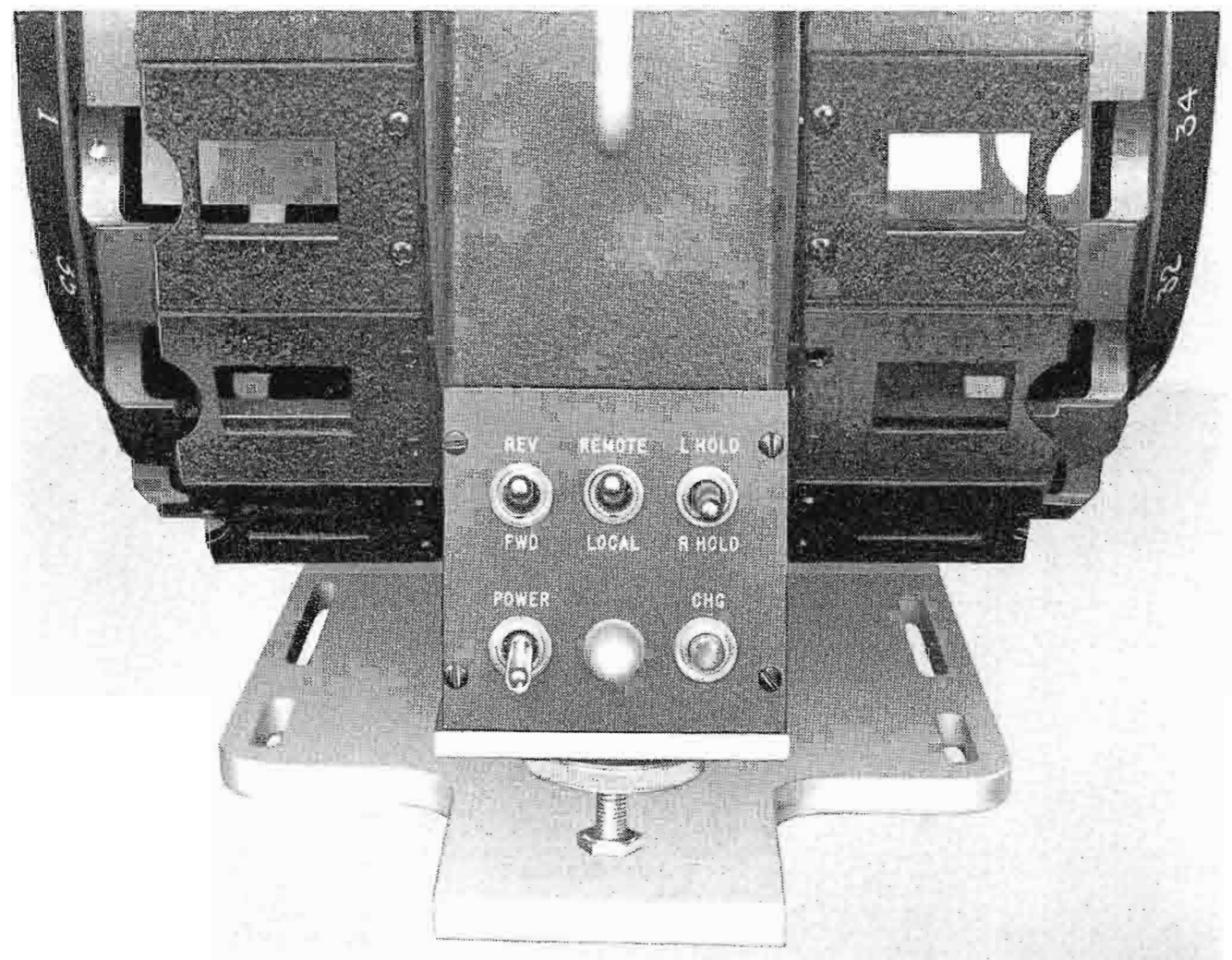

ing and safety features have been incorporated in the circuitry. The drum motors are energized finally by switches actuated by the mirror mechanism. The slide change button is disabled after a change has been initiated, in order to prevent switching back to the initial channel before a new slide has been advanced to the gate position. A pilot lamp for the channel on HOLD remains lit when the other channel is being projected, which is a visual reminder. Electrical braking of the drum drive motors is used to prevent the possibility of the motor and crank arm coasting and engaging the drum slot thereby displacing the slide in the gate. In addition, several contacts on the relays are utilized to insure operation of the relays in the proper sequence.

Local Controls

All local electrical controls are located on a panel at the rear of the projector. (See Fig. 14.) Five switches and an indicator lamp provide complete control of the pro-

jector functions. Toggle switches are used to turn the unit on or off, choose the direction of drum rotation and switch control of the projector to a remote source when desired. A pilot lamp indicates when the projector is on remote. A three-position switch provides normal sequential operation or holds either drum as desired, and a momentary contact push-button switch is used for manual slide change. Pilot lamps located at the top of the unit indicate the channel being projected.

Remote Control

The projector may be fully controlled from remote positions. In existing systems that now use the Projector Control Panel, MI-26256, or the TP-15 Control Panel, MI-40025, the TP-7A will perform the normal functions of existing slide projectors with the advantage of being capable of handling more slides. The on-off switch and slide change buttons will operate the TP-7A Slide Projector in a straight se-

quential manner. An auxiliary control panel, MI-40111, permits remote control of the "special" functions—REVERSE and HOLD. It contains all switch functions for the projector except ac power switching which is accomplished at the Projector Control Panel, MI-26256, or which is accomplished in the TP-15 system when Control Panel, MI-40025 is used.

Conclusion

The RCA TP-7A Slide Projector meets every essential requirement for both color and monochrome television broadcast use. In addition, it provides such additional features as emergency projection lamp, visual slide preview, high capacity, and easy loading. The components and materials used will provide long and trouble-free life. Simplicity of operation and servicing has been achieved in its design. Through its use, the television broadcaster will gain the high standards of reliability and performance demanded in present-day slide programming.

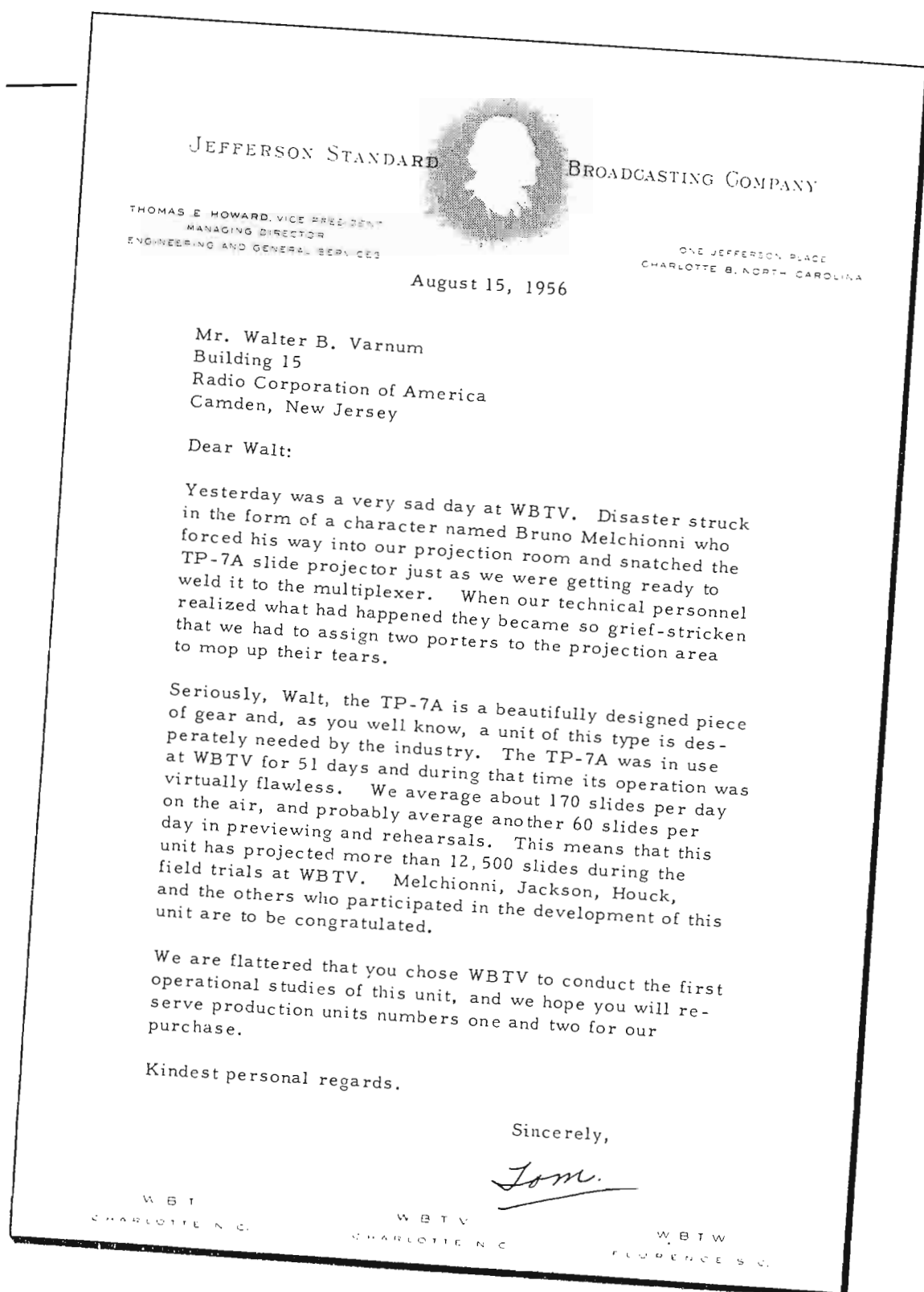

EDITOR'S NOTE:

The TP-7 Slide Projector was put through field tests in regular commercial operation. The letter shown is an unsolicited commentary from Tom Howard at WBTV, Charlotte, S.C.



HOW TO GET TOP PERFORMANCE FROM THE TK-21 VIDICON FILM CHAIN

FIG. 1. Typical Vidicon Film Chain employs the TK-21 Vidicon Camera and TP-11 Multiplexer.

by T. J. SHIPFERLING
and H. N. KOZANOWSKI

Broadcast and Television Engineering

Part Two of a Series:

How to Get Best TV Picture Quality From Films and Slides

In 1953 RCA first demonstrated the vidicon camera for high quality reproduction of motion-picture film. Since that time over 300 RCA monochrome vidicon film camera chains have been placed in service and these are now the accepted standard of performance for both network and regional station operation (see Table I). The vidicon film camera chain has consistently demonstrated the highest broadcast quality available from any commercial camera source, and most broadcasters are desirous of obtaining this level of quality in their daily operation.

During the last three years there have been rapid and substantial developments

in vidicon film-chain equipment, circuits, setup procedures and, as a result of field experience, improvements in actual operating techniques. In order that broadcasters may take full advantage of these new techniques it seems desirable to review the fundamental setup and operating techniques for vidicon cameras. In addition, some recommendations which were made in the past have been made obsolete by later developments.

To assist in checking, obtaining and maintaining top quality vidicon film camera performance, the following specific recommendations for setup and operation are presented.

Resolution

Sharpness or "snap" in the vidicon camera picture can be obtained *only* if the optical information is in best focus at the face plate of the vidicon itself, and if the electrical adjustments of the vidicon tube are chosen to fully utilize the optical information which is to be reproduced. *The optical and the electrical camera adjustments are of equal importance* in setting picture quality. For this reason the operator is urged to carry out the optical alignment of projectors, multiplexer and camera with great care, and satisfy himself that the required accuracy of adjustment has been obtained. The technique of "kicking" the projector and multiplexer into adjustment often gives disappointingly poor performance. Once good adjustment has been obtained and the *equipment fastened rigidly to the floor, and then re-checked*, the optical adjustments will require no further attention.

Although complete information on set-up and alignment is available in the instruction books, the following brief notes should prove useful in evaluating the accuracy of installations. At the outset it should be stressed that all multiplexer-type vidicon installations are in reality "in-line" optical bench systems which work beautifully when carefully aligned, but which may show vignetting, poor flatness of field and other deficiencies if one "short-cuts" good set-up practice.

Section I

OPTICAL ALIGNMENT

Align the TP-6, TP-16 or other projector on the optical axis using a field lens diagonal of the proper size (3.125 inch diagonal with the TP-11 and 5.55 inch diagonal with the TP-15 Multiplexer). Set-up masks of the proper size have been furnished with each multiplexer.

TK-21 With TP-11 Multiplexer

Insert the field lens aperture mask (3.125 inch diagonal) in the field lens position and substitute the vidicon "lens plug" in the normal vidicon lens position. This "lens plug" is provided as an accurate means of locating the optical center. The field lens aperture mask and "lens plug" are used as the "sights" for alignment of projectors, multiplexer and camera.

With the projector lens iris stopped down, and the projector lamp turned on, align the projector until the iris opening or pinhole falls on the center of the "lens plug." Now open the projector lens iris and check the image size at the field lens position. It should just fill the mask area

Table I—Capabilities of the TK-21A Vidicon Chain

- A. Resolution, horizontal: 600 lines center, 400 lines in the corners.
- B. Signal-to-noise ratio: 100/1 or 40 db with 3/1 aperture correction at 350 lines (measured as peak-to-peak signal to rms noise). A conversion factor of 1/6 gives the rms value of peak-to-peak noise which is observed on the oscilloscope.
- C. Gray scale range at least 50/1 (highlights to lowlights).
- D. Black level setting inherent in the vidicon tube itself.
- E. Flat raster obtainable with no external electrical shading required.
- F. Handles practically any film print density (80% to 3% highlight transmission) with constant signal-to-noise ratio.
- G. Operates at optimum performance with one-knob control of light from the projector varied in accordance with film density changes.

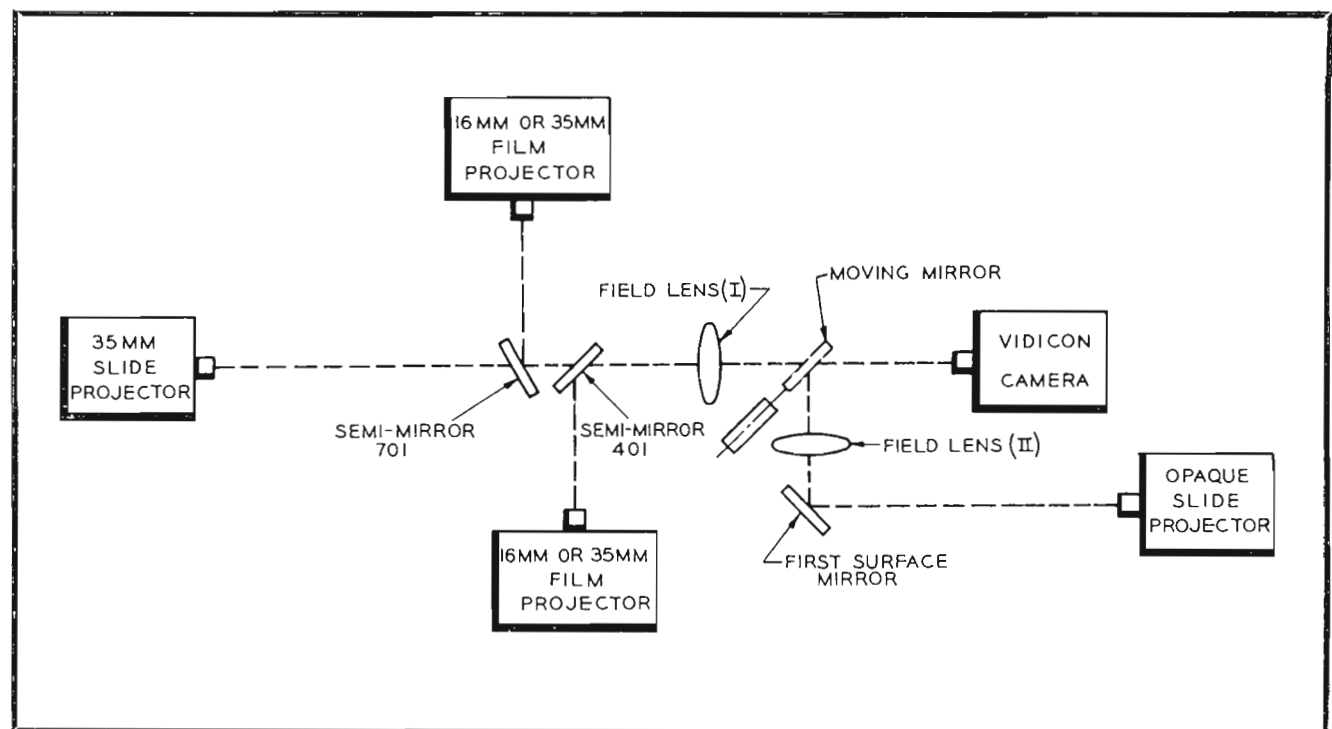

FIG. 2. Optical schematic of TP-11A Multiplexer.

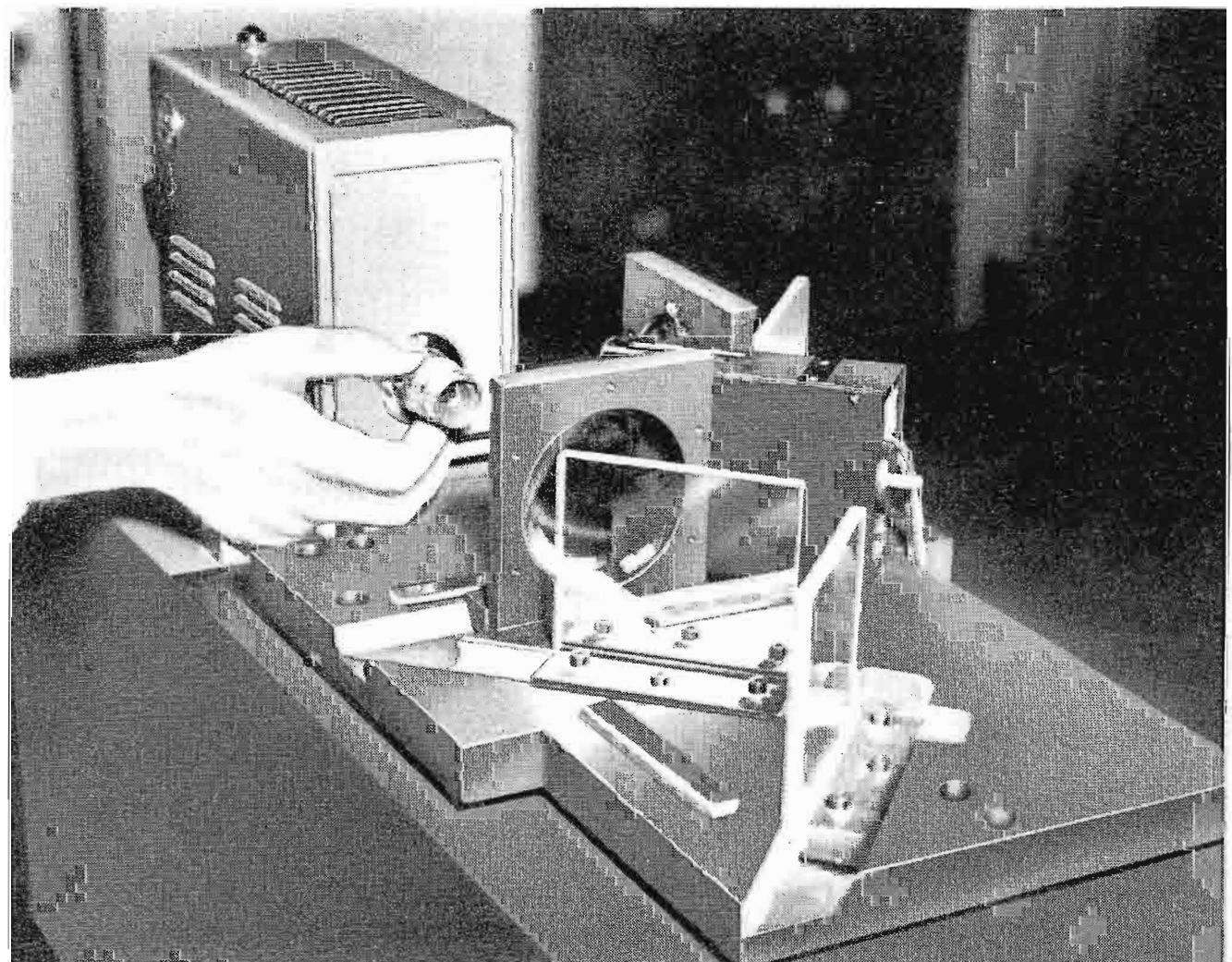

FIG. 3. TP-11 Multiplexer with cover removed.

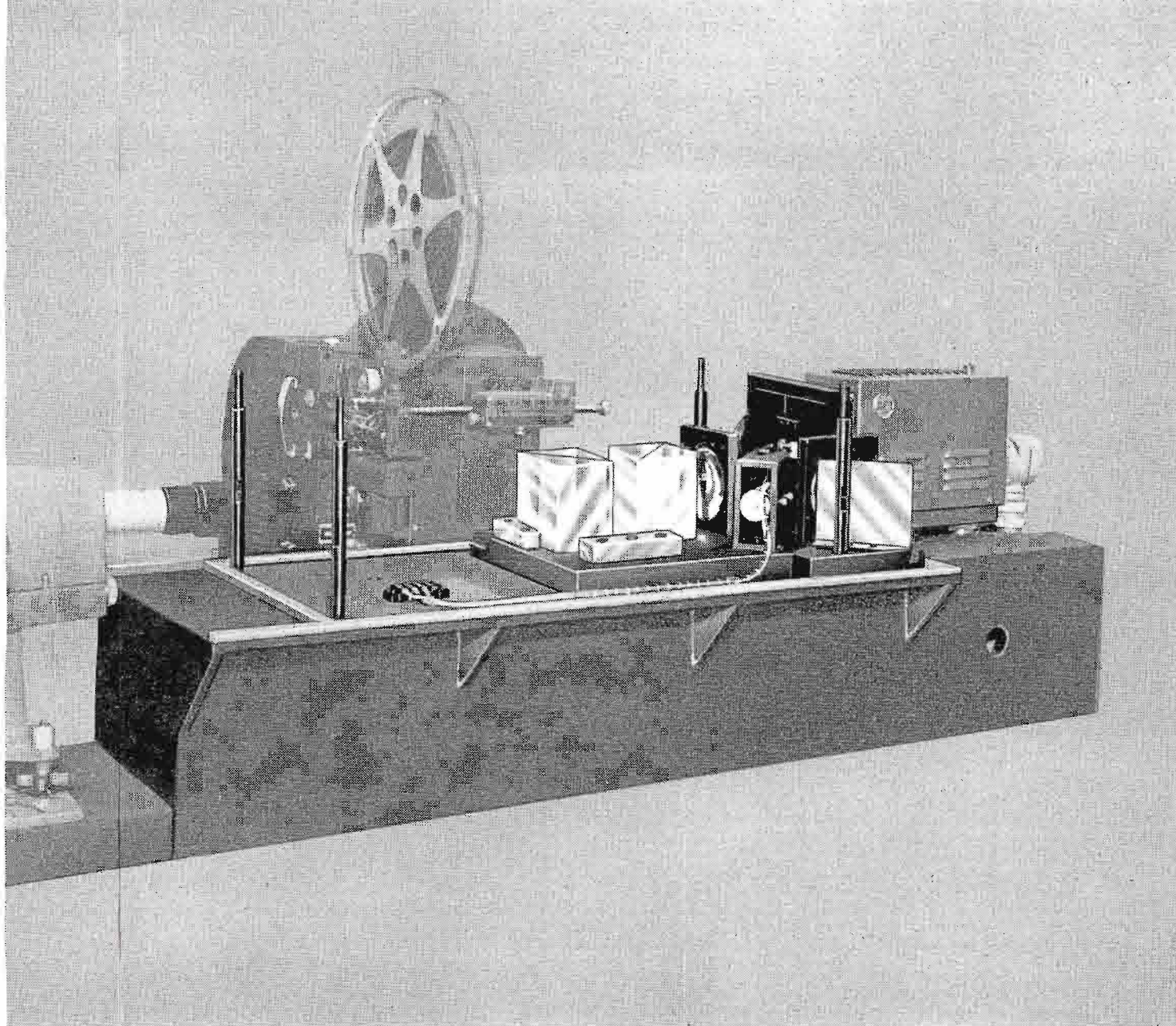

FIG. 4. TP-11B Multiplexer with cover removed.

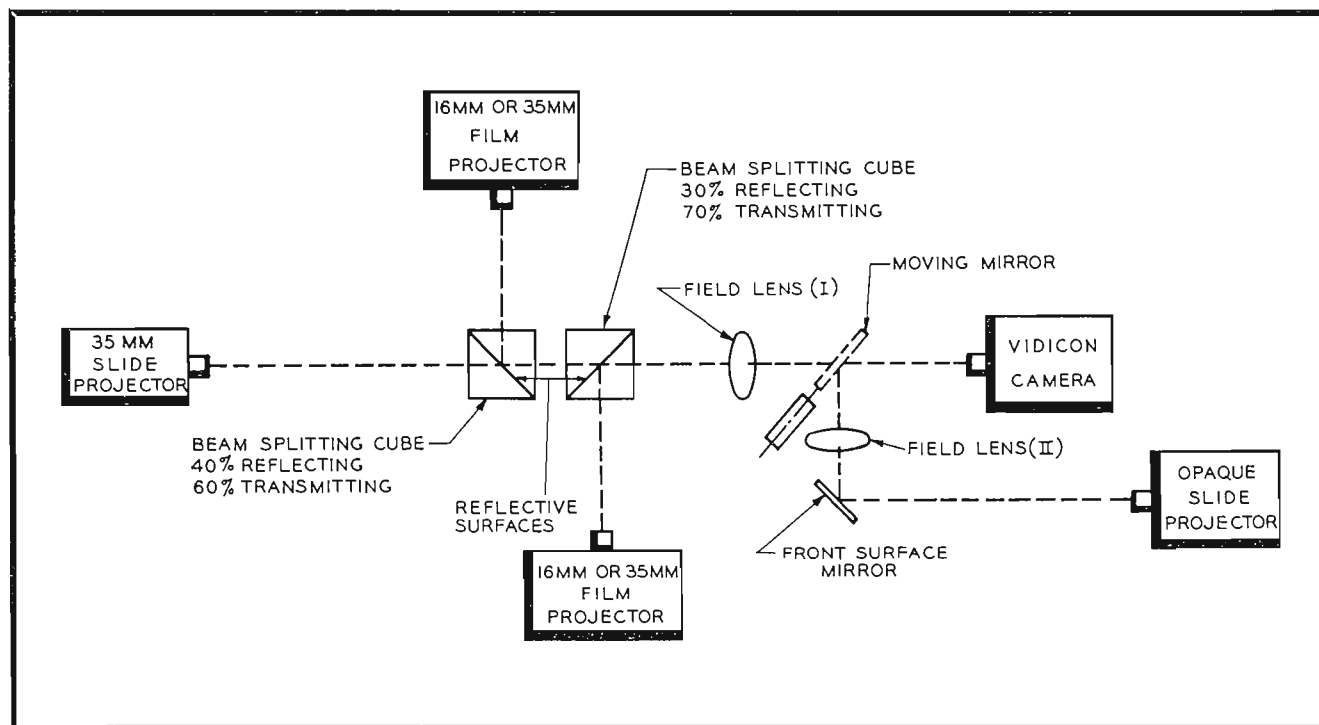

FIG. 5. Optical schematic of TP-11B Multiplexer.

and be centered in it both horizontally and vertically. Make sure that the image is focused in the center or mid-plane of the field lens. This can be checked by using a white card and observing that the focus of the images is the same immediately before and behind the field lens itself. The projector iris should be wide open when focusing the image since this requires the most critical setting. This alignment and size-setting procedure is repeated with all projectors which are to be used with the vidicon camera.

Now remove the camera "lens plug" and

place a paper mask ($\frac{1}{2}$ by $\frac{3}{8}$ inch with a 0.625 inch diagonal) in contact with the vidicon face plate. This can readily be cut in a circle whose diameter is that of the face plate (1 inch). Replace the camera lens (1 inch focal length F:1.9) and then adjust camera position, lens focusing, and vidicon scanning amplitude until the picture just fills the 0.625 inch diagonal. Remove the mask and then refocus the image for best sharpness. A suitable test pattern or test slide is used in the projector for this procedure. (Electrical alignment techniques will be described later.)

TK-21 With TP-15 Multiplexer

Optical alignment for the TK-21 on the TP-15 Multiplexer is the same as for the TP-11. However, since the field lens diagonal is 5.5 inches, a 3 by 4 ratio mask with 5.5 inch diagonal is furnished with the multiplexer for line-up. Instead of a "lens plug", the camera lens itself (2.04 inch F:1.5) is stopped down to its minimum iris opening and used as the alignment fixture.

The projector is aligned until the spot of light from the projector lamp irised source is centered on the camera lens iris opening. The image is of course centered in the field lens mask—the picture just filling the 5.55 inch diagonal. As before, a suitable test film or test slide, such as a RETMA print can be used.

This alignment procedure is repeated with all projectors, which should then be firmly fastened to the floor bed-plate structure to prevent accidental movement and consequent misalignment. Alignment of all projectors should of course be rechecked immediately after tightening the hold-down bolts.

It is poor practice to install and operate projectors and multiplexers without fastening them rigidly to the floor, since it is almost impossible to maintain satisfactory optical alignment under these conditions.

Section II

CHECKING FOR OPTICAL ADJUSTMENT

1. The vidicon camera lens iris must *always* be at maximum opening when used with a multiplexer field lens system. The cone of light from the field lens was designed to fill the camera lens aperture for maximum optical efficiency. Intercepting this cone of light with the camera lens iris will result in vignetting (perimeter shading or poor field flatness).

2. The projector lens iris should be stopped down to increase the depth of focus. This is desirable to provide latitude for warped film, reversed film emulsion position and decreased lens flare. A suitable stop is of the order of F:5.6. Further iris-ing will tend to focus projection lamp filament strands and produce vertical striations or shading bars.

If a projector has no iris, one can easily be fashioned from a stiff paper disk and inserted externally in the front portion of the lens barrel. The lens iris stop number is simply the focal length of the lens divided by the diameter of the opening. Make sure that the iris is centered on the lens axis for best performance.

3. The image on the vidicon photosensitive surface must be perpendicular to the optical axis to avoid image distortion and non-uniform focus. With correct camera positioning the image will go in and out of focus uniformly over the raster as the projector lens is moved. Non-perpendicular location of the camera will cause zonal focusing and inability to obtain good optical focus over the whole raster at the same time.

4. A vidicon image diagonal of 0.625 inch ($\frac{1}{2}$ by $\frac{3}{8}$ inch picture) was chosen to give maximum resolution and sensitivity, with adequate field flatness. Smaller rasters will result in poorer resolution and sensitivity since both of these are a function of the raster dimensions.

5. Optical shading (non-flatness of field in the picture output) is usually the result of improper optical system alignment, improper projector lamp condenser lens assembly, or improper projector lamp alignment. Other sources of shading (electrical adjustments) and how to identify them will be considered later.

6. In some earlier models of TK-21 Vidicon Cameras, lenses with somewhat limited performance were furnished. These can now be *exchanged* for the lens (Kern-Paillard-Pizar) supplied in current equipment. This lens has excellent performance for vidicon service.

7. The TP-11 Multiplexer uses stationary neutral density transmission-reflection mirrors. These are coated on one side with a Magicote "C" surface to minimize undesired or ghost reflections. With the surface in good condition the amplitude of these ghosts is negligibly small (0.5 per cent). However, with accumulations of dust or oil film, such ghosts may become troublesome. The neutral density mirror surfaces under these conditions should be cleaned carefully with an approved cleaning agent as described in more detailed instructions, available in the multiplexer installation notes. This will restore the non-reflective layer to its original condition. If repeated cleaning has damaged the coating, it will be necessary to replace the mirrors. These can be recoated by RCA if otherwise in good condition.

(A recent multiplexer design now being introduced uses glass beam-splitting cubes for the multiplexing operation instead of the conventional flat plate mirrors. These eliminate ghost reflections completely and offer very stable, easily cleaned operating surfaces. Details on field modifications to former designs now available—see p. 82.)

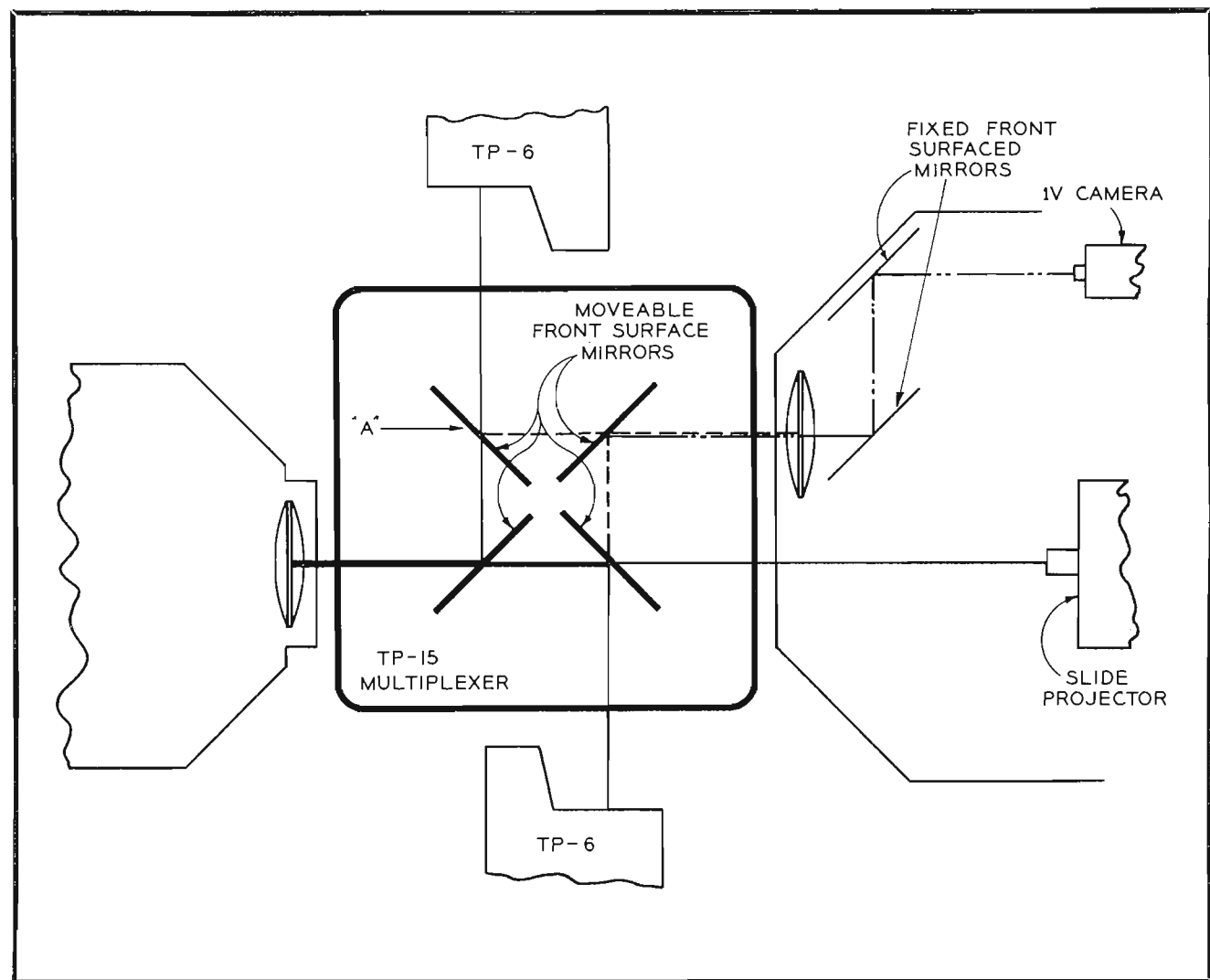

FIG. 6. Optical schematic of TP-15 Multiplexer.



FIG. 7. TP-15 Multiplexer with cover removed.

Section III

ELECTRICAL ADJUSTMENT PROCEDURE

Set the *vidicon signal electrode voltage* at 25 volts. Using the slide or film projector (open gate) adjust the projected light intensity to obtain a vidicon signal current of 0.3 microamperes, with the photo-conductive scanned surface completely discharged.

Electrical Focus

Place a test film or slide in the projector, set vidicon beam focus control to mid-range and adjust focus coil current for best resolution of test pattern. *Be sure to trim optical focus during this procedure.* The magnetic focus coil current should be approximately 40 ma for normal operation.

Alignment of Vidicon Beam

Adjust the vidicon alignment coil controls for image swirl around the approximate center of the raster with flattest shading and best corner focus as major determining factors when the beam focus control is "rocked" through focus. Always check size and centering of the raster image after completion of beam alignment.

Some operators find that maximum over-scan both horizontally and vertically during the alignment procedure aids them in identifying best alignment adjustment. Scanning is then restored to its normal amplitude. The alignment procedure is more subtle with vidicons than with image orthicons and careful alignment will produce best and most symmetrical corner resolution.

Signal Electrode Voltage

Select the optimum signal-electrode voltage for flattest field (minimum shading). In general, electrode voltages of the order of 10 volts will produce "port hole" or dark-edge signals, while a voltage of 50 volts will produce flare or bright edge signals.

The procedure is to illuminate the raster uniformly (open-gate condition) and to vary the signal electrode voltage and light intensity to maintain a 0.2 microampere signal current. This represents an *average* or typical operating condition which serves as a good basis for settings.

The signal electrode voltage is varied until a satisfactory flat raster response is obtained on the video monitor oscilloscope (horizontal sweep rate). If there is any question as to the flatness of illumination from the projector (which obviously affects the video output), the vidicon camera

should be swung on its mount so that it can be illuminated from an external point source *with the camera lens removed*. A frosted incandescent lamp three or four feet from the front of the camera is a completely adequate source of uniform illumination. The video signal under these conditions is therefore a characteristic of the vidicon signal-electrode voltage only.

Skillful set-up will allow for compensation of small projector porthole errors by small vidicon flare components to produce very flat overall raster response. One must be careful to use such techniques with caution and in moderation since various projectors may have different field flatness characteristics, and switching among several sources may introduce appreciable shifts in the character of the video signals.

Vidicon Bias and Beam Current

In the operation of a vidicon camera the scanning beam flows through the photo-conductive layer in accordance with the variations in intensity of the light-image, thus creating the video signal. The number of electrons starting from the cathode is governed by the potential of the negative or control grid. As the number of available electrons increases, the picture "develops" on the monitor with the low-lights showing first. Further decrease of bias is necessary until the highest highlights are discharged. However, further decrease in bias produces *no increase* in signal, and will cause deterioration in center and corner resolution, raster distortion and even local split-image formation. *Use only enough beam bias setting to just discharge the highest highlights.* This assures the maintenance of best size scanning spot and resolution.

At first glance this may look like a critical adjustment to maintain. However, due to the stability of vidicon cameras, the required condition can be set up quickly and then practically forgotten during a normal day's operation. In fact, this logic is basic to an understanding of all vidicon film camera operation.

Constant Quality Operation

By setting up the *peak* condition of 0.3 microamp signal current for an all-white or open-gate raster, one automatically selects the correct bias to discharge any highlight which comes up to this level. Since normal highlight transmission for good film release prints is 50 per cent, such an adjustment gives a safety factor of 2 to 1 for very thin film inserts which seldom exceed 80 per cent of open-gate transmission.

Signal currents of this order will provide excellent signal-to-noise characteristics. Higher signal currents will produce deterioration in resolution and lower ones will result in inadequate signal-to-noise. The only condition which must be met is that of keeping the vidicon operating at the optimum point which we have selected (0.3 microamperes open gate). *This is very easily fulfilled by controlling the light through the motion-picture print so that the same peak highlight video signal is developed under all conditions of film density.*

In actual practice this *film highlight density* does not vary greatly during a given reel of a release print, especially in films made for television. Therefore, by the recommended set-up procedures a film may run completely unattended.

However, with poor control of commercials inserted into feature films and in reruns of old-time movies the problem of operation becomes more exacting. Basically, the solution lies in single-knob control of the light intensity through the film. (The various methods of doing this will be considered in the section entitled: *Film Density Changes and Operating Procedures.*)

Filament Voltage Effects

In several instances it has been found that due to low line voltages, the heater voltages in the vidicon camera are below the nominal 6.3 volts ± 5 per cent. This may result in a poor signal-to-noise ratio due to the decrease in performance of the cascode input video amplifier stage. It may also result in inability to completely discharge the highlight areas of the picture (insufficient beam due to low vidicon cathode temperature). Beam-splitting may also take place due to poor cathode emission caused by too low an operating temperature.

Note that heater voltage transformer taps are provided to take care of various lengths of camera-to-control cables.

Operating "filaments-only" on stand-by is not recommended because of contamination effects in grids and cathode of present-day close-tolerance amplifier tubes.

Image Burns

The vidicon under the conditions of TK-21 operation is not normally sensitive to "image burns". However, burn will result if a bright image remains on the photo-sensitive surface for a long time. Exposing the photo-cathode to "open gate" lighting will usually "wash" image burns away in a short time.

Camera Cooling and Ventilation

Special tube radiating shields and a replacement ventilation housing with integral centrifugal blower are available for locations where excess temperature rises are encountered.

Interference and Pickup

The TK-21 Camera used with a TP-15 Multiplexer requires that the lens mounting bracket be grounded directly to the vidicon camera with a wide ground strap to avoid "ground-loop" interference pickup. For installations where impulse-type interference is severe, a barrier-type camera cable is available for the TK-21 for effective electrical filtering. The TK-21 Camera has built-in barrier filters.

FIG. 8. Neutral density disk video control for slide projector.

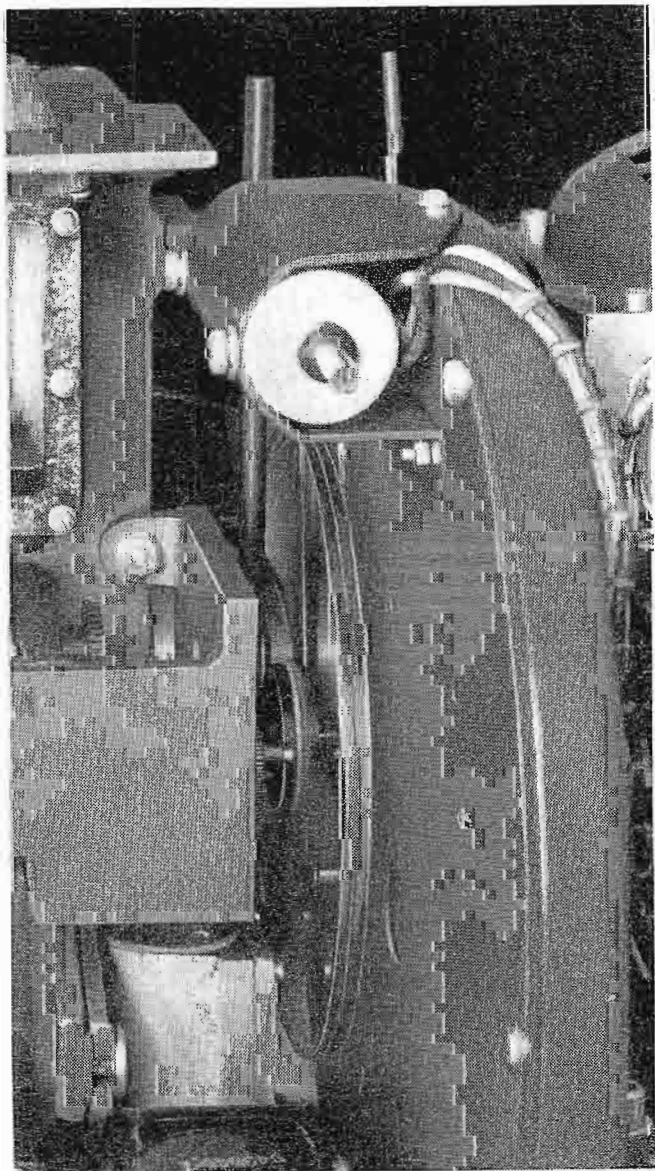
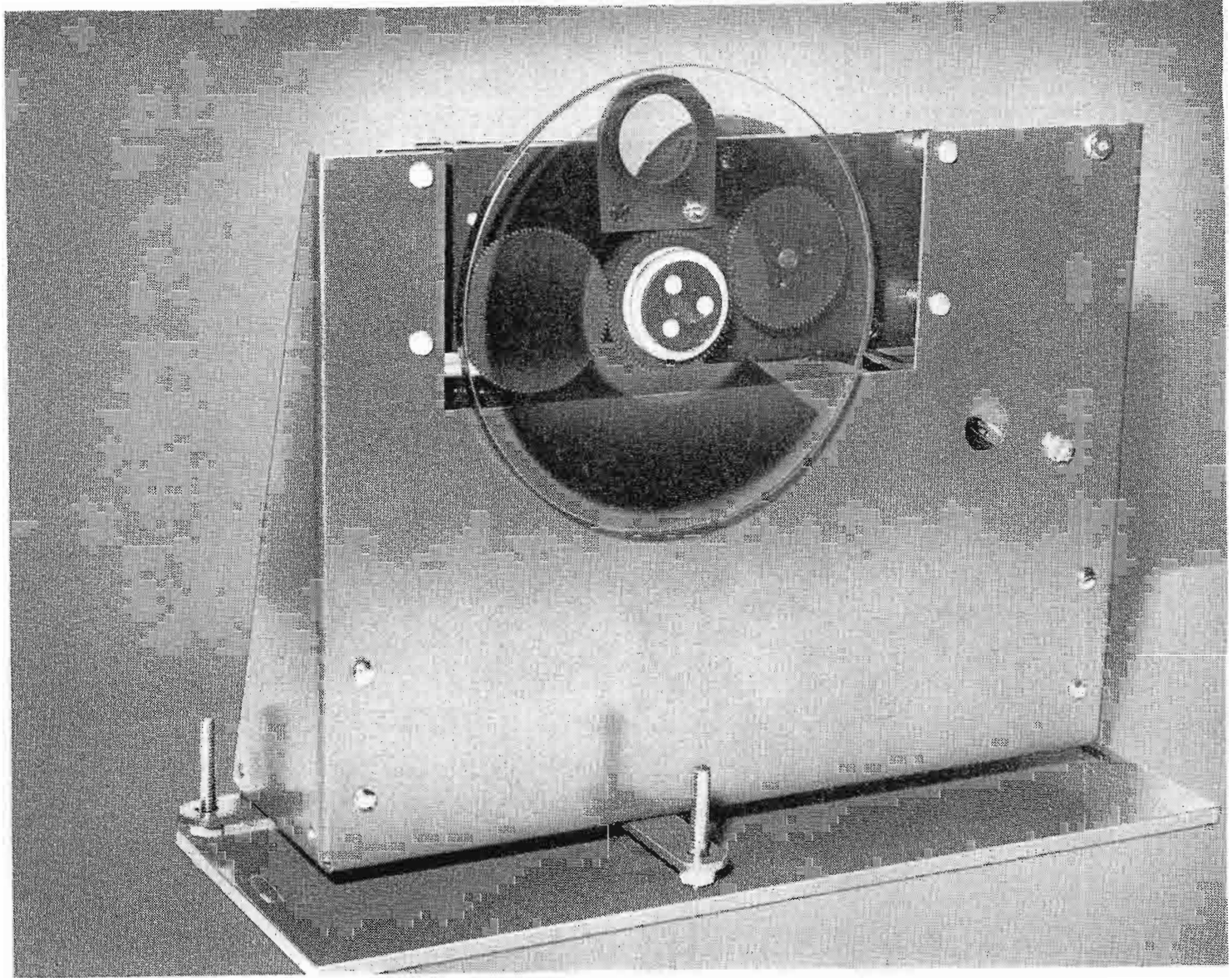

FIG. 9. Neutral density disk video control built into 16mm motion picture film projector.

Section IV

FILM DENSITY CHANGES AND OPERATING PROCEDURES

Constant Video Output Level

In a broadcast installation the camera video output level should be so controlled that a constant peak-to-peak video signal is developed for network transmission or transmitter modulation. In practice it is necessary to compensate for variations in film density from reel to reel, and to some extent from scene to scene. This will achieve the concept of "constant quality" type of operation desired by the broadcaster.

Neutral Density Disk Video Control

The most satisfactory method of maintaining constant video output level is by means of a neutral density disk in each projector light path which is servo-controlled by a single-knob at the operating position. The disk used in the RCA TP-6 and TP-35 Projectors is a continuously tapered metallic film having a transmission range of 100 to 1 and having no selective color-shift characteristics with density, making it ideal for color as well as monochrome film reproduction control.

In setting up the control for monochrome film transmission the neutral density disk is set at mid-range, a film or slide of aver-

age density (50 per cent highlight transmission, D equals 0.3) is placed in the projector and fixed neutral density filters in front of the projector lens are used to pad down the light output to give proper video level on the output scope. (*Projector lamp voltage can also be set below nominal rating—prolonging lamp life greatly.*)

The control is then set by the video operator in accordance with *film density* variations to maintain constant video output. *Film density variations are differences in highlight transmission* from film to film or section to section due to variations in processing control. *Film range or contrast ratio* is the ratio of light transmission in the highest scene highlights to the light transmission in the lowest lowlights. Typical values for good television release prints are 50 per cent highlight transmission, 1 per cent lowlight transmission—range is therefore 50 to 1.

By comparison, density variations of as high as 80 per cent highlight transmission and 3 per cent highlight transmission have been found in current releases. The contrast range in both prints can be the same, but the 3 per cent transmission print *requires almost 27 times the light from the projector* to develop the same video output signal. Automatic control of projector light output so as to maintain constant video

output level has been successfully demonstrated and is in actual program use.

Projector Lamp Voltage Control

In vidicon operation, control of the projector light output level by varying the lamp filament voltage is a simple and effective means of compensating for film density variations and operating at "constant quality." The variation in lamp color temperature with voltage is of no consequence in monochrome film reproduction but presents some limitations in color reproduction of color films.

Projector filament voltage control can be obtained with a rheostat, variac or reactance dimmer (magnetic amplifier). Rheostat and variac controls are rather bulky and inconvenient to use, especially when several projectors are involved. An RCA 1-KW Reactance Dimmer developed for this service can be mounted in the standard equipment rack and controlled from the operating console position with a standard potentiometer.

In adjusting projectors using projector lamp filament control, first set filament voltage to mid-range (90 volts) and use

the previously described technique of average density film and neutral density filters to adjust the light level for correct video output and proper vidicon operating conditions. It is good practice to stop down the projector lens by at least one stop to minimize the effects of warped film and reversed emulsion.

Neutral density Wratten filters are those commercially available at local Eastman Kodak photography stores. These are marked by logarithmic density designations, examples of which are shown in Table II.

Table III—Suggested Items to Facilitate Equipment Adjustment and Maintenance

- (1) RETMA Resolution test slide.
- (2) " Linearity test slide.
- (3) " Registration test slide.
- (4) SMPTE Logarithmic step wedge test pattern.
- (5) RETMA Aperture test chart.
- (6) RCA Aperture (burst frequency) test slide (with frequency bursts of 0.5 mc; 1.0 mc; 1.5 mc; 2.0 mc; 2.5 mc; 3.0 mc; 3.5 mc; 4.0 mc).
- (7) SMPTE A strip of 16mm film with resolution test patterns on same.
- (8) Supplied with TK-21 and TP-11 Multiplexer.
 - (a) Field lens mask with 3.125 inch diagonal.
 - (b) Vidicon camera lens substitution tool ("lens plug") for optical alignment.
 - (c) Vidicon image size and centering mask with 0.625 inch diagonal.
- (9) Supplied with TK-21 and TP-15 Multiplexer.
 - (a) Field lens mask with 5.5 inch diagonal.
 - (b) Vidicon image size and centering mask with 0.625 diagonal.

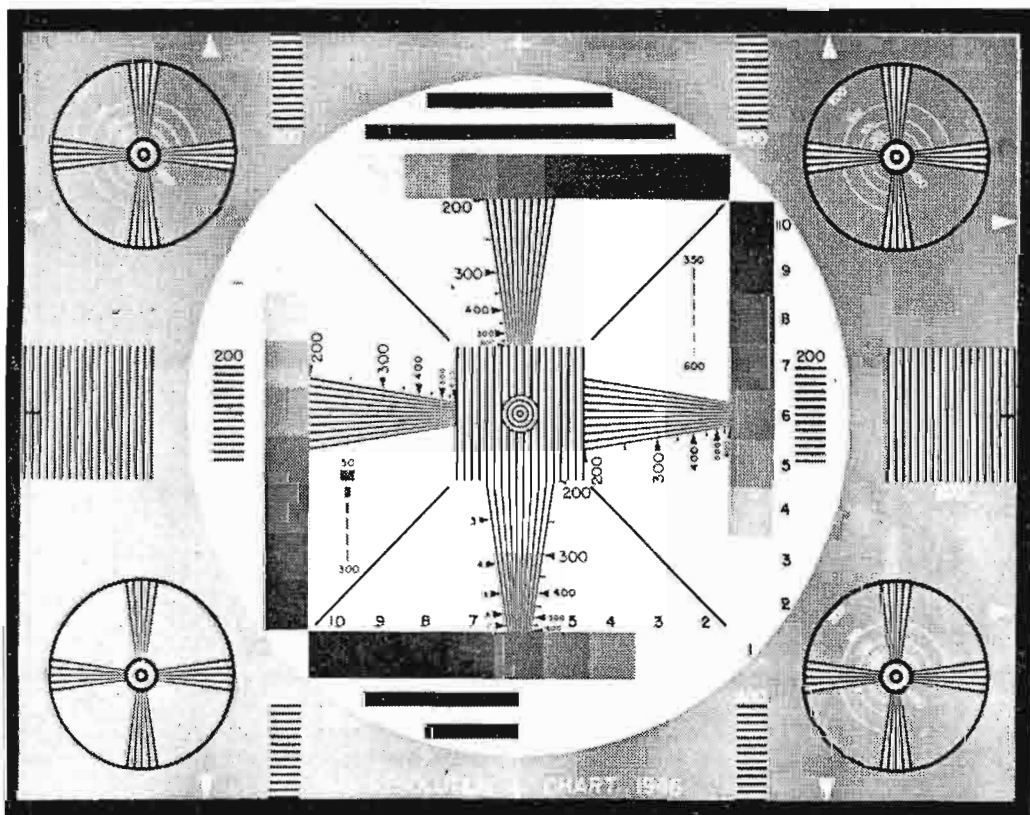

FIG. 10. RETMA Resolution Chart.

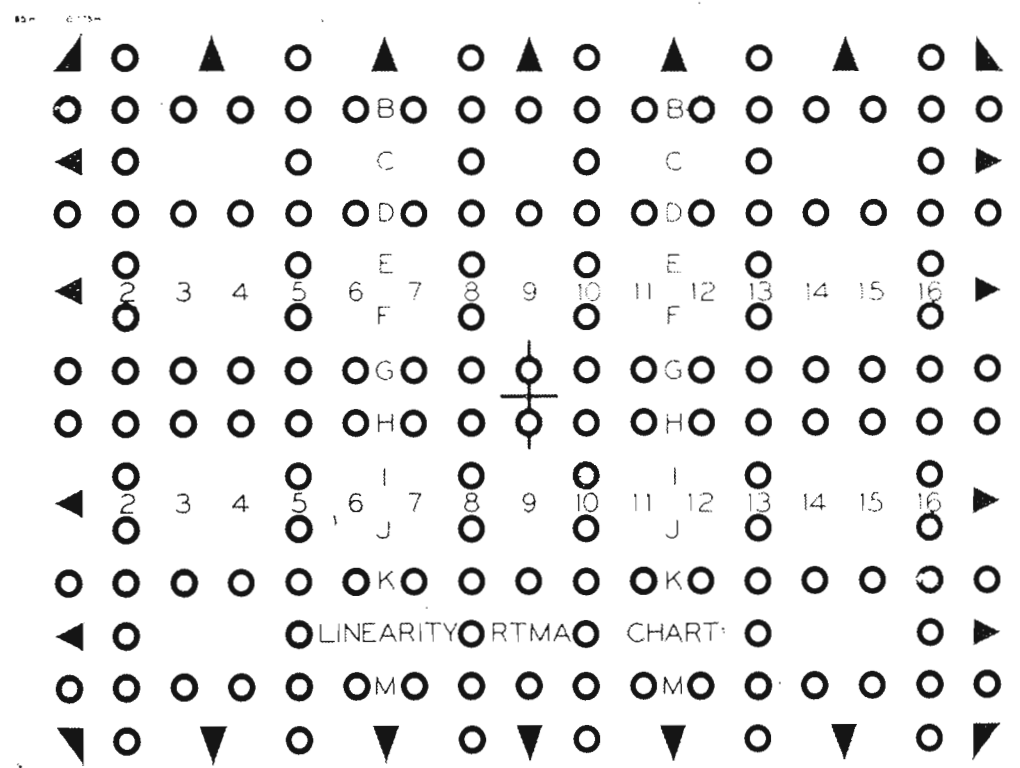

FIG. 11. RETMA Linearity Chart.

Signal Electrode Control

During early stages of development, tentative recommendations were made on varying the vidicon signal electrode voltages to compensate for film density variations. *This practice is no longer recommended and should be replaced by the foregoing recommended methods.* Varying the signal electrode voltage changes the shading characteristic of the video output signal, distorts the vidicon transfer or gamma characteristics and produces shifts in black-level behavior which are hard to

Table II—Neutral Density Filter Specifications

Density of Filter	Transmission Ratio	Transmission in Per Cent	Lens Stop Variations
0.3	2:1	50	1 down
0.6	4:1	25	2 "
0.9	8:1	12	3 "
1.2	16:1	6	4 "
1.5	32:1	3	6 "

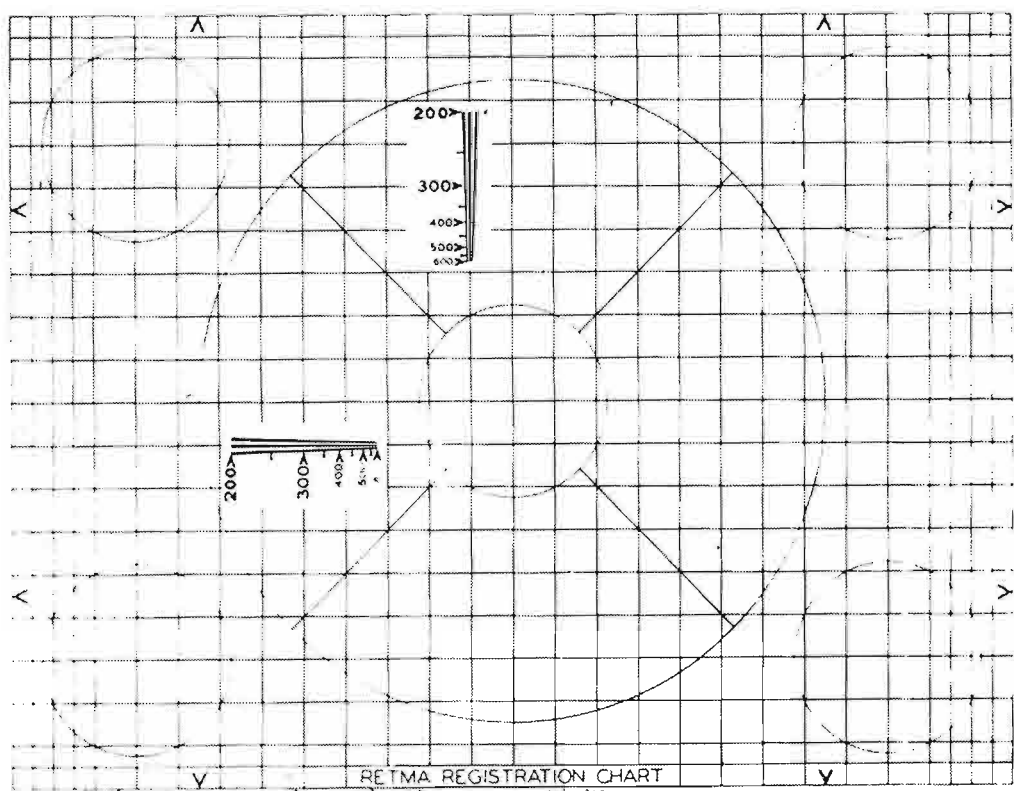

FIG. 12. RETMA Registration Chart.

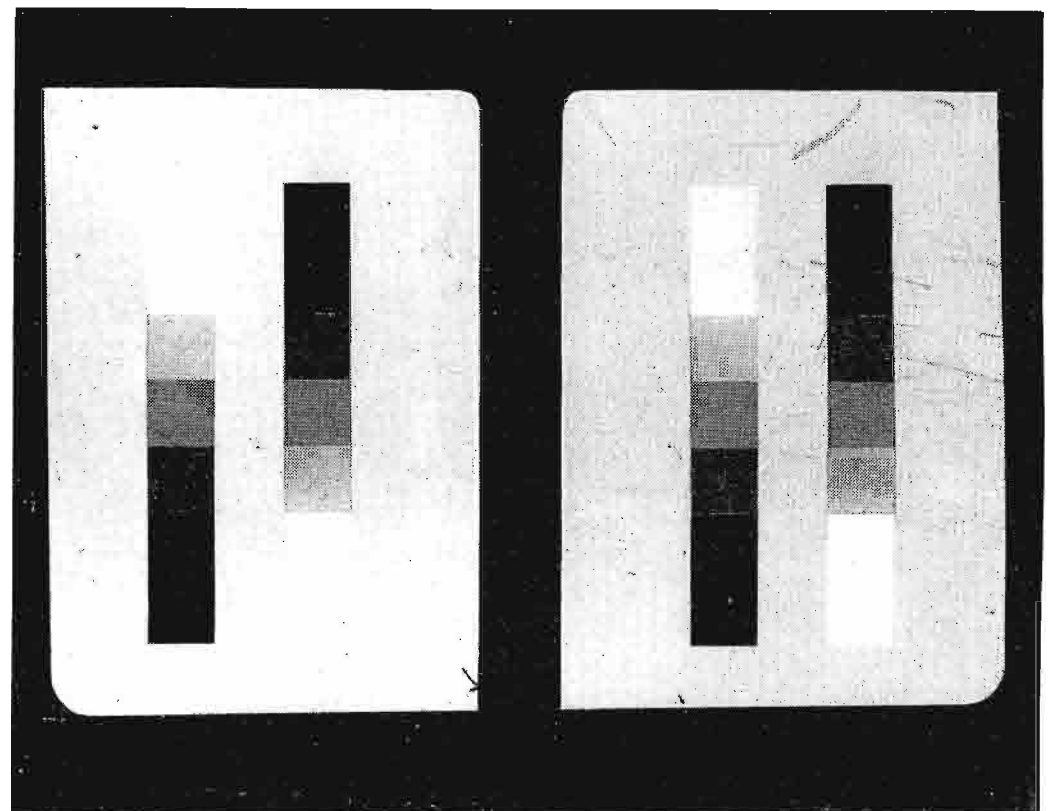

FIG. 13. SMPTE Logarithmic step wedge test pattern.

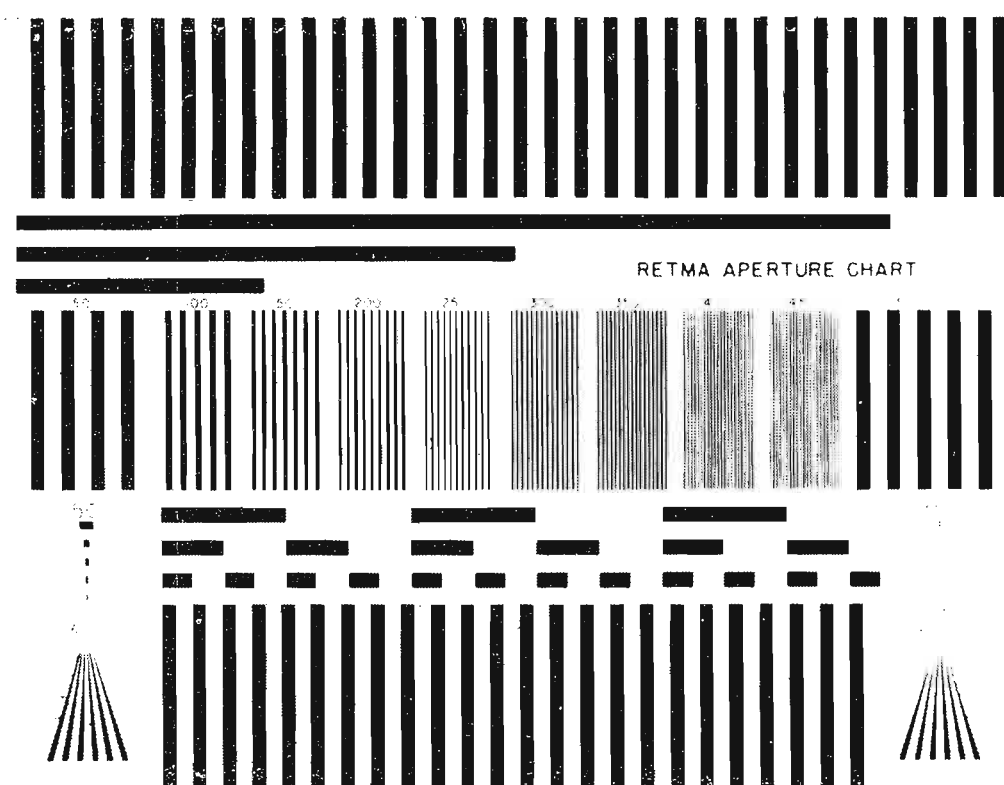

FIG. 14. RETMA Aperture Test Chart.

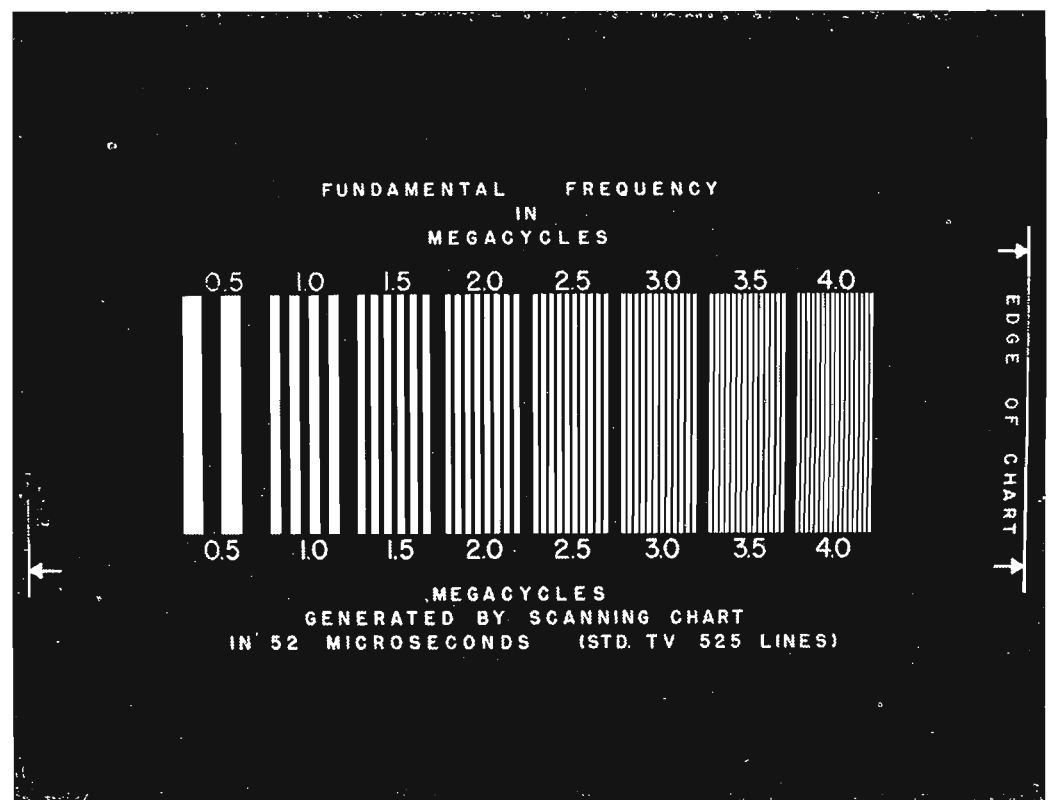

FIG. 15. Special RCA Aperture Test Chart.

control. In addition, the signal-to-noise-ratio may vary unpredictably.

Video Gain Control

Varying the vidicon video amplifier gain as an operational control for film density variations is not recommended under any conditions. This method of control can cause excessive signal-electrode current, poor resolution, overloaded amplifiers, streaking and a constantly varying signal-to-noise ratio.

Automatic gain control amplifiers may have useful application for "trimming service" where the signal-to-noise performance is not seriously affected.

Video Signal Corrections

The control or processing amplifier includes a variable aperture compensator (which boosts high frequency amplitudes without phase distortion), variable gamma control (a field modification), and a portion of the high-peaking or correction for the vidicon output capacity.

Aperture Corrections

Aperture compensation amplitude should be adjusted for a 3 to 1 boost at 350 lines. This will give 100 per cent response to test pattern transitions up to this line number. Line-selector oscilloscopes or burst-frequency slides available for this purpose can be used for adjustment. The amount of boost used is limited by the additional shot-noise introduced in the picture. Aperture compensation in effect compensates for the finite diameter of the scanning beam and increases the effective horizontal resolution. Vertical resolution is unaffected by this process.

Gamma Correction

Some broadcasters have expressed the desire for additional gamma compensation to improve the reproduction of high contrast film. Information is available for field modifications to give variable gamma correction slopes of 0.5, 0.7 and 1.0 in addition to the vidicon gamma of 0.65. These slopes can be selected by a three-position switch. Logarithmic crossed gamma wedges are available with a 60 to 1 range in seven steps on 35mm SMPTE Test Film stock. They can be mounted in 2 by 2 inch slides for system tests and set-up.

High Peaking

The RC high-peaking adjustments are divided between camera video amplifier and processing amplifier. The RETMA resolution test slide is recommended for high-peaking adjustments. With correct high peaker setting there will be no black

Table IV—TK-21 Modifications Now Available

- | | |
|-----|---|
| (1) | Variable gamma modification Technical Bulletin, Code No. FE196 (available upon request from Broadcast Sales Department). |
| (2) | Neutral density disk servo amplifier modification to improve stability of operation. |
| (3) | Modification of TP-11 from flat mirrors to prisms. (Kit of parts and instructions.) |
| (4) | Modification of signal level control using the reactance dimmer. |
| (5) | Modification of signal level control using the neutral density disk. |
| (6) | Modification of camera, lens changed to Kern-Paillard 26 mm f1.9. (This modification should already be on TK-21s.) (Exchange of lens, no charge.) |
| (7) | Modification of the vidicon camera to include a blower assembly to avoid excess temperatures in camera. |

or white streaking following all horizontal black bars of the RETMA Test Pattern slide.

Deflection Linearity

A RETMA linearity or ball chart is most convenient for linearity check and adjustment. Use a 17 vertical line, 14 horizontal line grating signal from a grating signal generator.

For two per cent maximum deviation all lines must touch the perimeters of the 17 by 14 circle array of the RETMA pattern. For one per cent or less deviation, all horizontal and vertical lines must touch or fall within the circles located along each line.

Failure to obtain the required linearity is usually due to insufficient deflection power caused by sagging tubes or components, or poor contacts in the connecting cables along which the deflection waveforms are transmitted.

Section V

MAINTENANCE SUGGESTIONS

Lenses and Mirrors

Keep lenses and mirrors free of dust, dirt and oil scum. These materially reduce contrast and increase ghost reflections. A solution of pure isopropyl alcohol mixed with 10 per cent distilled water is recommended for cleaning coated lenses and dichroic surfaces. Apply carefully with a wad of cotton and wipe off with high grade cheese cloth. Streaking can be removed by breathing on the surface and carefully wiping.

Multiplexer Mask

This field lens mask can remain on the lens. A quick inspection through the multiplexer cover port will indicate any changes in alignment or image size.

Field Lens Image

The projected image should be in focus in the mid-plane of the field lens. Check with white card technique in Section I on Optical Alignment.

Fixed Neutral Density Padding Filters

These should be mounted in glass (Eastman slide glass is adequate) to avoid warpage, dirt and fingerprints. When adding or removing glass-bound filters from the optical path, readjust optical focus.

The vidicon chain should be checked regularly with the recommended techniques to avoid deteriorating quality and to assure top performance.

Conclusion

In all of the previous discussions the tacit assumption has been made that the quality of the motion picture film is ideal or at least adequate. This is a dangerous assumption since very often, particularly in old 16mm releases, this is not the case. No television system can do very much to make film of poor technical quality look better on television than it looks on critical viewing with direct projection. Fortunately, the importance of TV film programming is becoming so great that the technical quality of films produced especially for this purpose is better and more uniform than was formerly the case. Continued pressure by the sponsor, the agencies and the broadcaster himself will undoubtedly raise performance still more.

EDITOR'S NOTE: In order to provide the broadcaster with additional information as rapidly and completely as possible, address all inquiries regarding vidicon film chains to: Broadcast Equipment Sales, Building 15-6, Camden, New Jersey. This procedure will facilitate the flow of information from the Engineering Department back to the broadcaster.

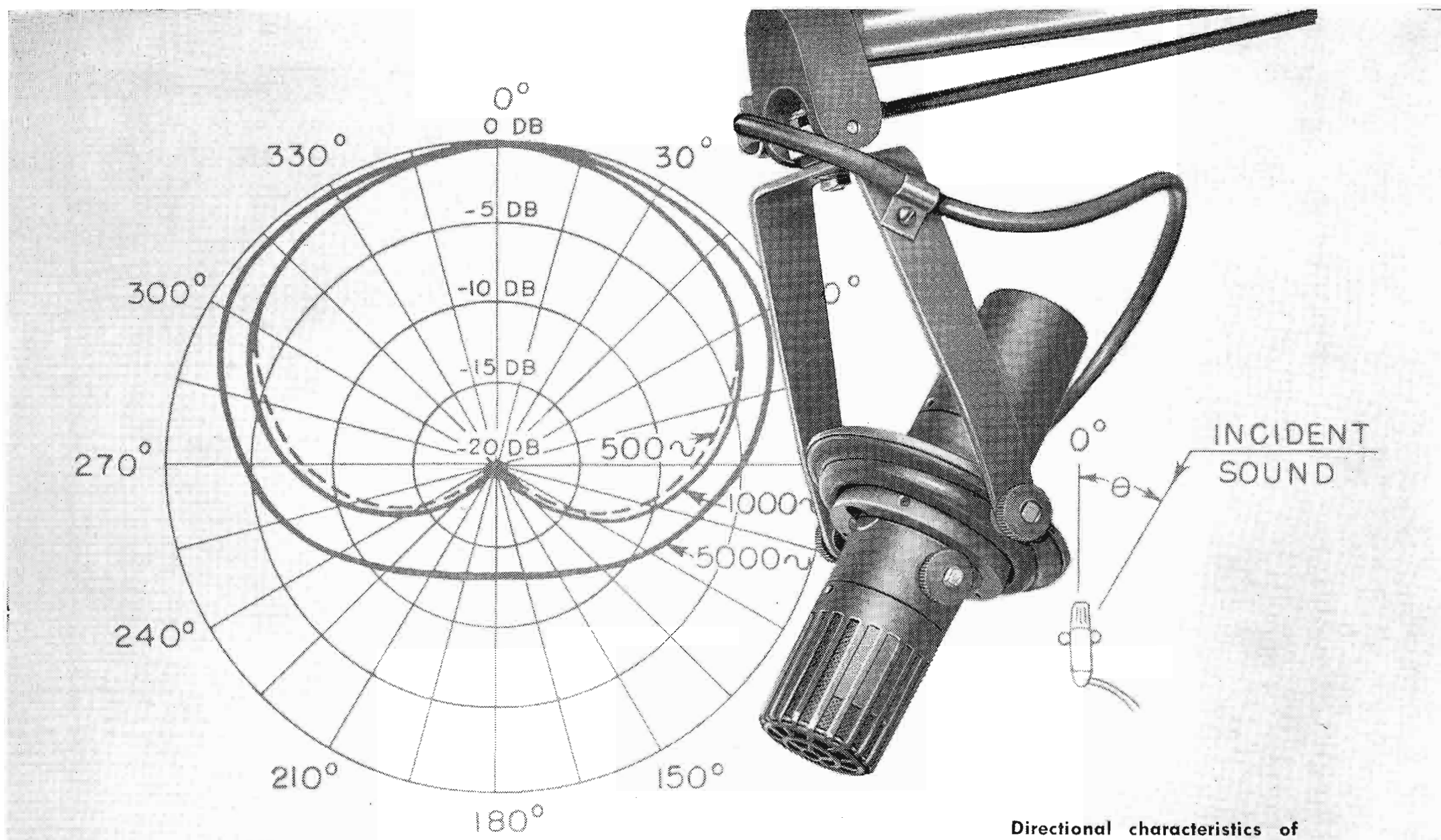

Directional characteristics of the BK-5A Microphone about the vertical axis.

Order Now...

RCA's BK-5A UNIAXIAL MICROPHONE

Today's most versatile sound pickup unit

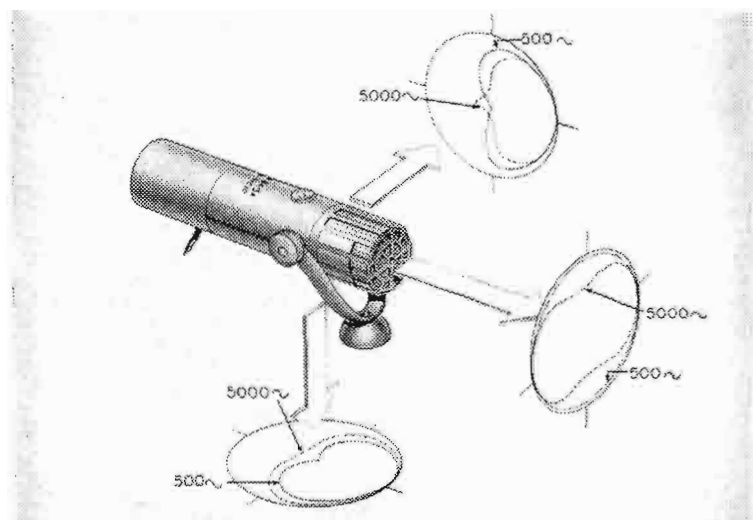

DIRECTIONAL CHARACTERISTICS about the major axis. At low frequencies the pickup pattern is a true cardioid. At 5000 cps and above, the pattern becomes fan shaped.

The RCA Uniaxial Microphone meets the increasing need for a high-quality ribbon microphone with superior directional characteristics. This microphone is truly uniaxial; its direction of maximum sensitivity has been designed to coincide with the major axis of the microphone. The BK-5A is built for simple and sure handling when mounted on a boom. Its improved shock mount effectively isolates microphone from

boom support and does not itself generate any noise, thus assuring noise-free handling. Sensitivity to wind is also reduced. Premium performance, classic styling and ease of handling will assure years of successful application.

Ask your RCA Broadcast Sales Representative for complete information. In Canada, write RCA VICTOR Company Limited, Montreal.

FEATURES OF RCA TYPE BK-5A MICROPHONE

- ★ Uniaxial feature simplifies microphone and camera placement
- ★ Improved directional characteristics with wide pickup angle
- ★ High quality reproduction to 15,000 cycles
- ★ Small and lightweight for TV boom operation
- ★ Sturdy construction with blast filter to reduce effect of violent noises
- ★ Exceptional shielding for operation in high hum fields
- ★ Wind screen available for outdoor use or fast-panning shots
- ★ No rubber bands to replace, with new shock mount
- ★ Improved longer-life flexible cable

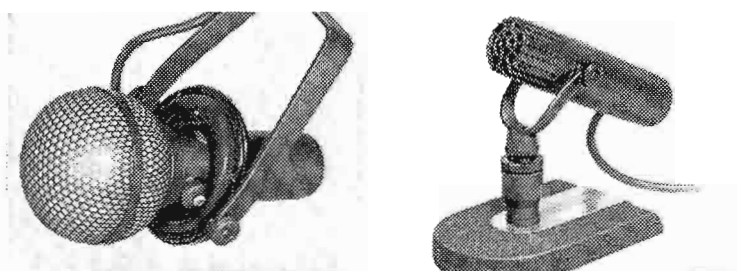

BK-5A Microphone with Wind Screen and new, improved Boom Mount. BK-5A mounted on Type 91-C Desk Stand.

Pioneers in AM Broadcasting for Over 25 Years



**RADIO CORPORATION
of AMERICA**

BROADCAST AND TELEVISION EQUIPMENT

CAMDEN, N. J.

now a 6KW



Really space-saving!

Where floor area is at a premium, such as in "down-town" buildings, or where space must be yielded to other equipment, the TT-6AL is highly adaptable. Its design permits it to be mounted flush to a wall or in a corner of the room. Even in open space it occupies less than 63 sq. ft. When new transmitter buildings are contemplated, the space-saving TT-6AL helps to save building costs. The fact that the rectifier section can be separated and placed in an adjacent room or basement is an added feature that saves valuable operating area.

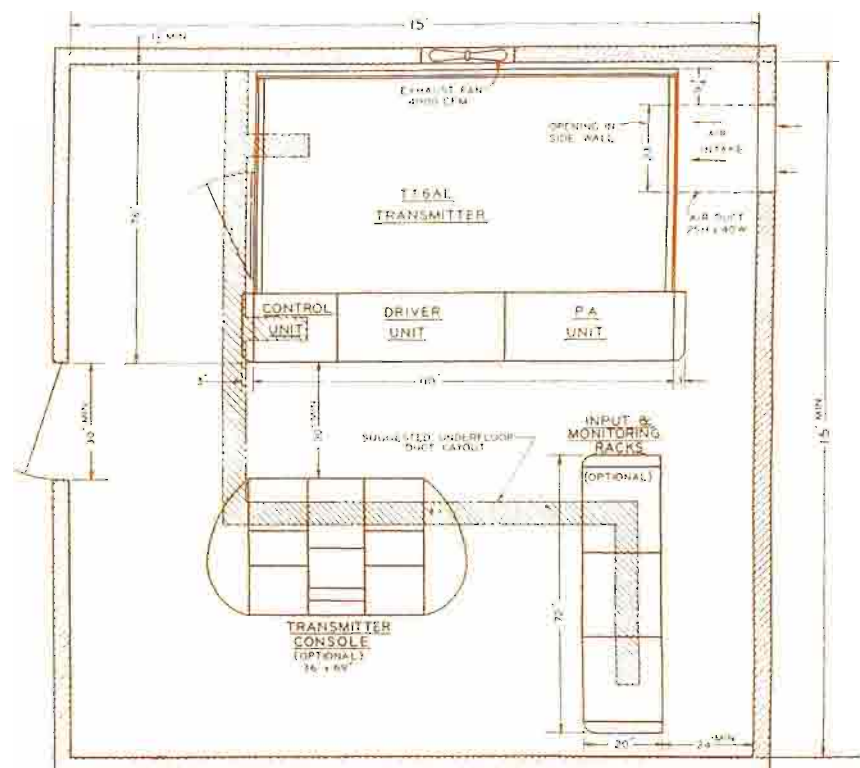

RCA PIONEERED AND DEVELOPED COMPATIBLE COLOR TELEVISION

VHF transmitter!

**featuring unusual compactness and economy
...with power reserve to drive a 25KW**

Newest and most advanced in the RCA line of low band VHF television transmitters, the completely-new-design TT-6AL is the answer to medium power low band requirements and simple increase to 25KW.

- ★ **Most Compact Floor Plan Ever Achieved** —Requires less than 63 sq. ft. of floor area (less than any 5kw). Transmitter can be placed flush to a back wall or in a corner of a room. Rectifier enclosure can be separated from transmitter and located in an adjacent room or basement.
- ★ **Design Reflects Color Experience** —Built-in linearity correction circuits and intercarrier frequency control which accurately maintains frequency separation between aural and visual carriers, assures excellent color signal transmission.
- ★ **Excellent Accessibility** —Broadband tuning controls are accessible without opening any doors. All important circuits are adjusted from front of transmitter. "Tilt-out" construction of modulator and exciter units (see photo below). Only one interlocked door for complete transmitter.
- ★ **Economical and Reliable Operation** —Uses Type 5762 air-cooled tubes, famous for long life and reliability. Complete overload protection with "grouped" indicator lights makes trouble-shooting quick and certain.
- ★ **Simple Power Increase** —The TT-6AL easily drives a 25kw amplifier. Readily converted to higher power with minimum changes.
- ★ **Thermostatically Controlled Heaters for Rectifier Tubes** —Suited to ambient temperatures as low as 0° C. Designed for attended or remote-control operation.

plus... many other advanced features too numerous to mention here. Get the complete story from your Broadcast Sales Representative or write for descriptive literature (Catalog Bulletin B-4005). In Canada, write RCA VICTOR Company Limited, Montreal.

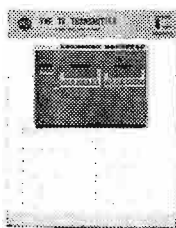

Maintenance accessibility has been given particular attention in the TT-6AL. Exciter (shown tilted forward) and modulator chassis are made accessible by hinged doors and "tilt-out" chassis design. An optional spare exciter unit can be rack-mounted for added "on-air" assurance.

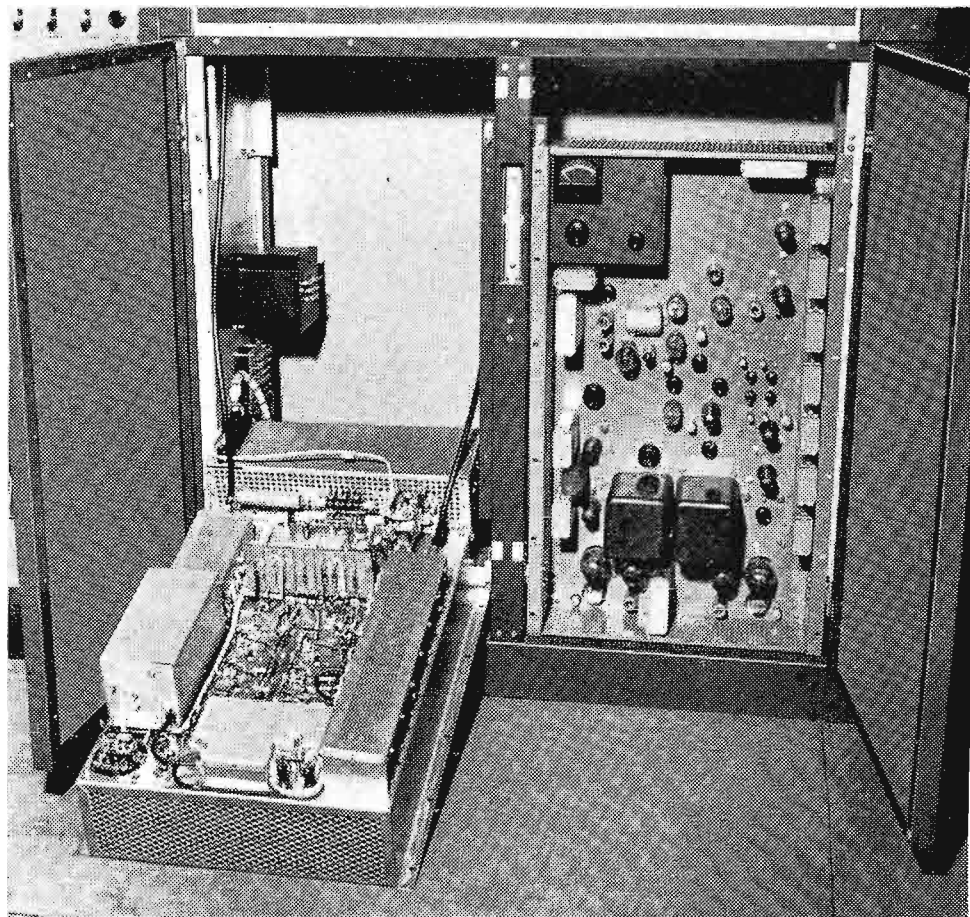

RADIO CORPORATION of AMERICA

BROADCAST AND TELEVISION EQUIPMENT • CAMDEN, N. J.

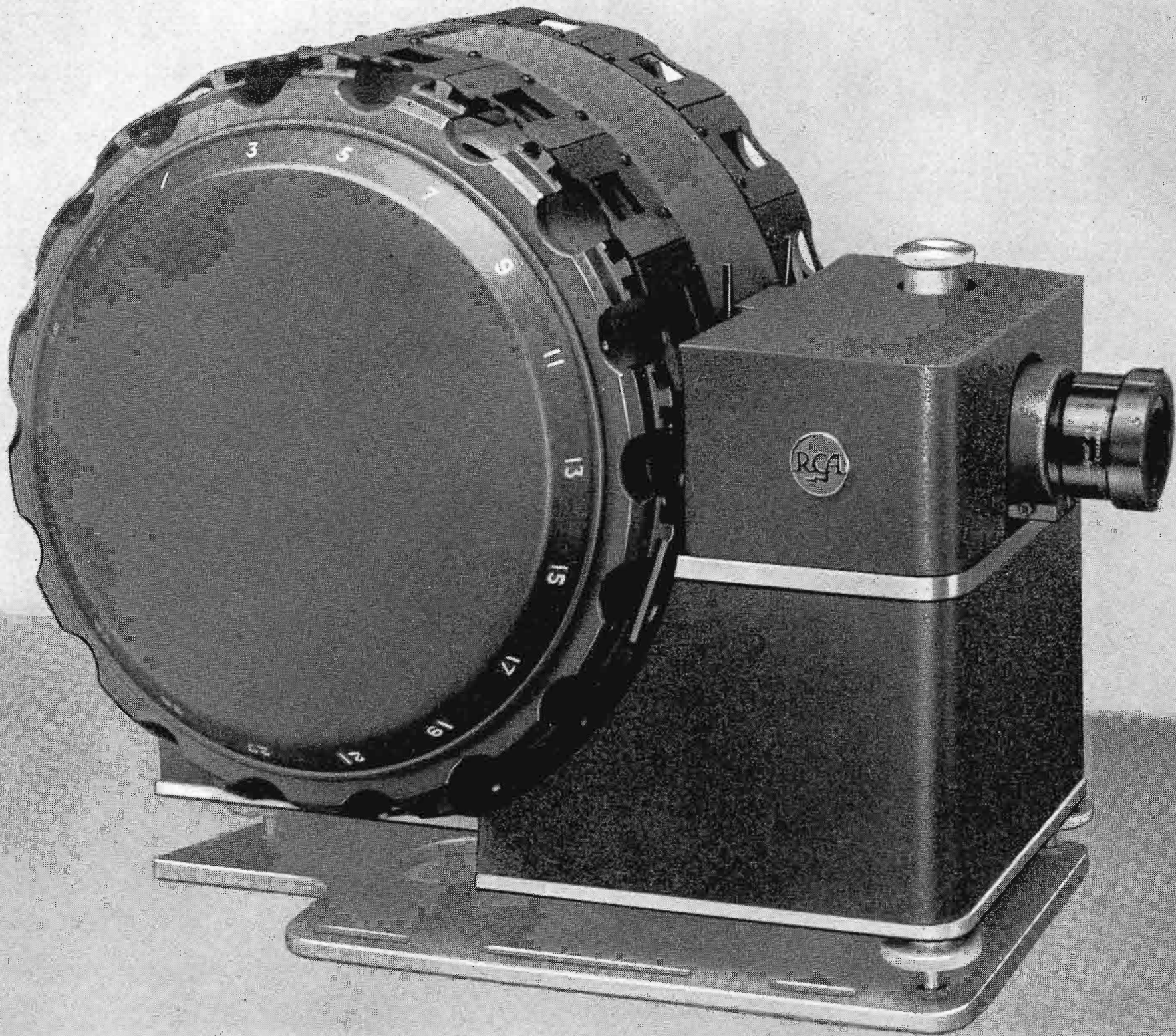

New High-Capacity TP-7 Slide Projector. Dual drums hold a total of 36 slides. For top performance in color and monochrome.

REMARKABLE NEW FEATURES ASSURE

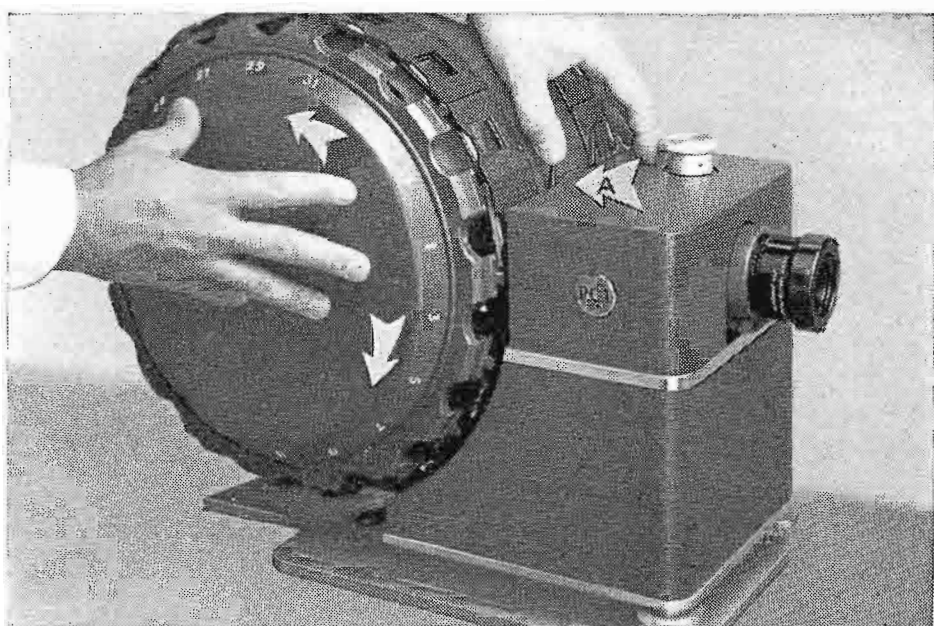

MECHANICAL VERSATILITY

"Free wheeling" principle, with simple lever release (A), permits either drum to be twirled for easy inspection and slide changing. Slides move smoothly and lock securely in show position. Each drum can be operated independently of the other.

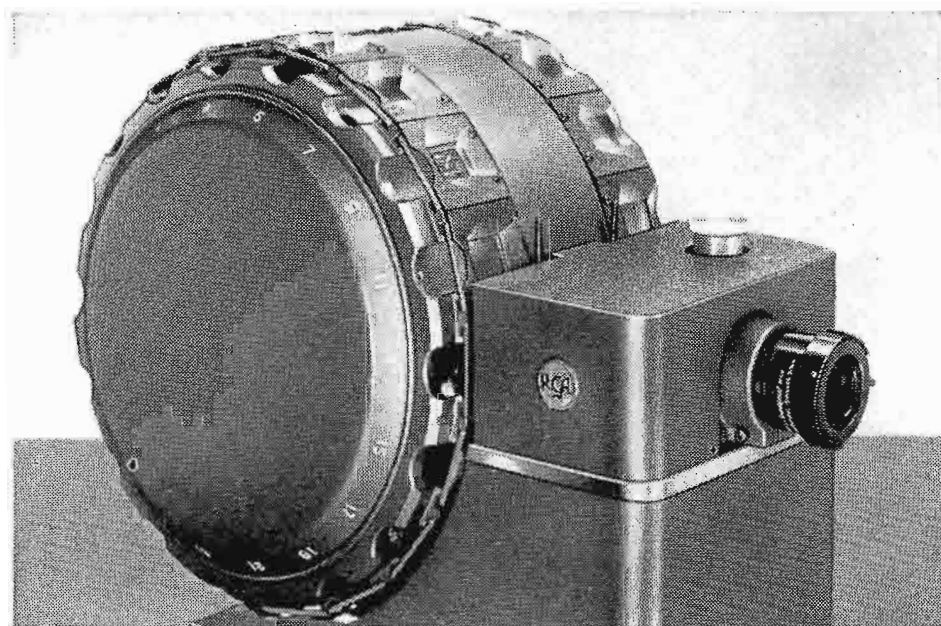

PREVIEW CONVENIENCE

All slides are illuminated for easy viewing making it easy for projectionist to preview them. Last-minute changes can be made before they reach the "show" position.

You told us what you wanted . . . we listened,
designed, field tested . . . with the result:

DESIGNED
THE WAY
YOU WANT IT!

This new professional slide projector excels in performance and operating convenience!

Recognizing the increasing importance of slides in programming at every television station, RCA resolved to do something about the projection equipment.

SURVEY OF USERS—At the outset, a survey was made among users of film-slide equipment to find out what was wanted most.

NEW DESIGN PROJECTOR—The result is a truly professional projector for television use that is exactly tailored to your needs . . . with so many operating advantages it's a pleasure to use! It has an ideal capacity of 36 slides—large enough for handling 99% of all station needs, yet just right for ultra flexibility.

SUCCESSFUL FIELD TEST—The TP-7 Slide Projector has been field tested in actual day-to-day service at a busy television station—WBTV, Charlotte, N.C. So successful was this trial run, the station people did not want to part with the projector when the test was completed!

"OPERATION VIRTUALLY FLAWLESS"—According to Thomas E. Howard, WBTV Vice President and Managing Director of Engineering and General Services, "During the testing period, the TP-7's operation was virtually flawless. An estimated 12,000 slides were run, 170 slides per day on-air, 60 slides in previews and rehearsals."

*Write for illustrated brochure containing complete information
In Canada: RCA VICTOR Company Limited, Montreal.*



RADIO CORPORATION of AMERICA
Broadcast and Television Equipment Camden, N. J.

OPERATIONAL CONVENIENCE AND FLEXIBILITY

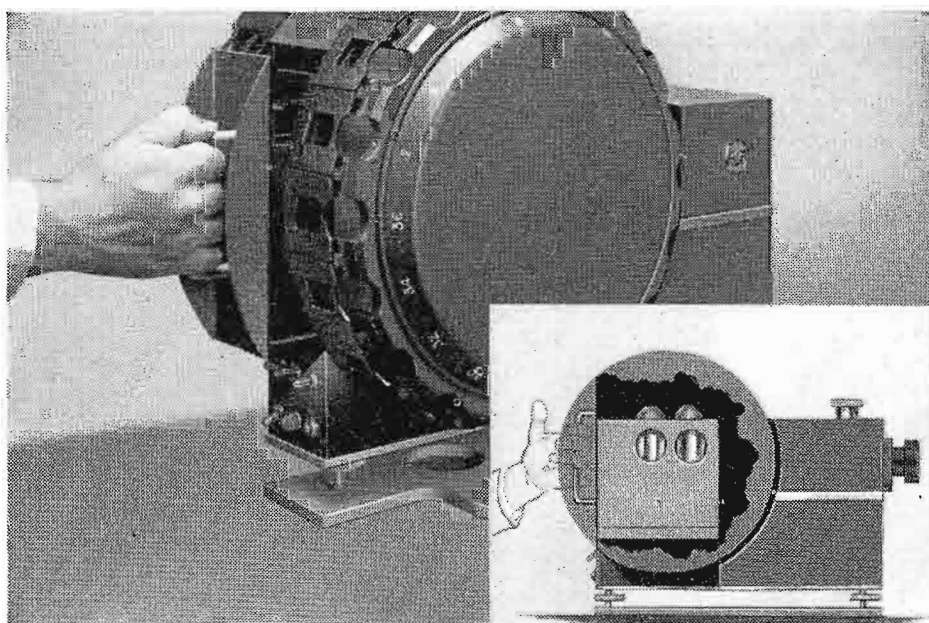

QUICK LAMP CHANGE

Use lamp to failure—reserve lamp instantly slides into place. Highest type optics for uniform brightness over entire field of projected image. One-lamp source eliminates color balance problems.

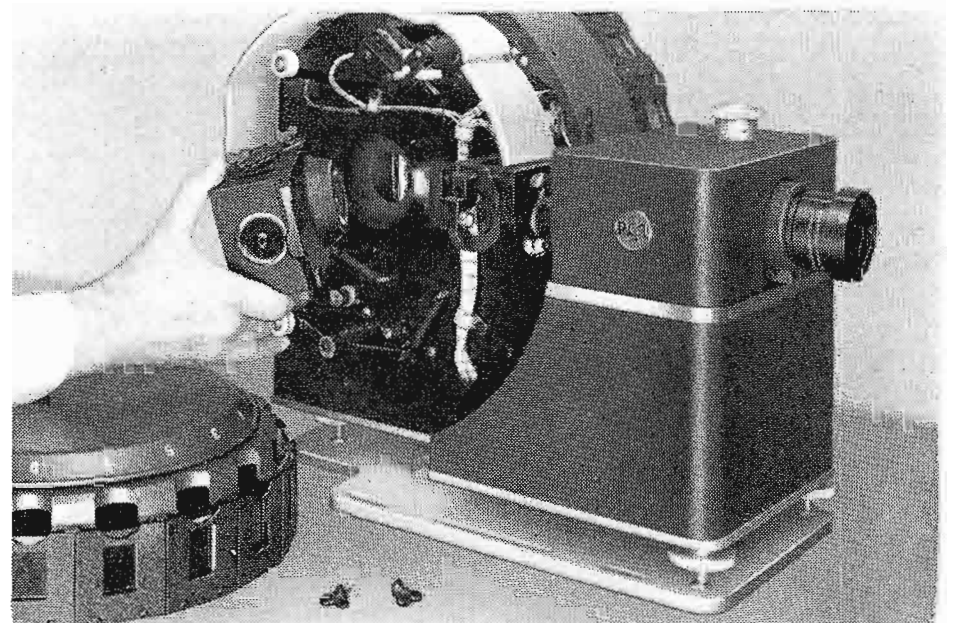

UNITIZED CONSTRUCTION

Designed for ease of operation and servicing. Drums, drum-covers and optical assemblies are easily removed for cleaning and maintenance.

500 WATT and 1 KW RCA AM TRANSMITTERS

TYPE BTA-500MX • TYPE BTA-1MX

for economical and reliable
broadcast operation

These two new transmitters are designed specifically to meet critical broadcast needs. Both provide maximum adaptability for dependable remote control operation.

Simple to install and maintain, they offer maximum efficiency and economy in continuous broadcast service. The RCA "MX's" are today's best transmitter buy with outstanding performance features to meet today's competition.

SUPER PERFORMANCE—Here's proof of outstanding performance. Lowest distortion ever . . . less than 2% typical at 15,000 cps. Wide-range frequency response . . . essentially flat between 30 and 15,000 cycles. Bi-level modulation incorporated in both units means absolute minimum distortion, reduced carrier shifts, over-all increase in broadcast efficiency. Conservatively rated components and cooling add long-life reliability.

SIMPLIFIED OPERATION—Single control tuning located on functional front panel is the only control needed for all normal adjustments. The crystal oscillator trimmer can be adjusted through the front panel while the transmitter is in operation. Filament voltages on all transmitter tubes can be adjusted from the operating panel.

SPACE SAVING . . . TUBE SAVINGS—Important space savings are achieved with only 6.2 square feet required overall. Operating with fewer tubes and fewer tube types (15 tubes in the 1MX, 14 in the 500MX and only 4 types), the problem of stocking tubes is helped from a space-saving as well as a money-saving standpoint.

COMPLETE ACCESSIBILITY—Vertical construction, exclusive at these powers, provides instant access to all components for visual inspection or ease of replacement.



See your nearest RCA Radio Broadcast Sales Representative or write for brochure containing complete technical specifications. In Canada: RCA VICTOR Company Limited, Montreal.

REMEMBER—RCA TRANSMITTERS HAVE THE HIGHEST RESALE VALUE OF ANY TRANSMITTER ON THE MARKET!



**RADIO CORPORATION
of AMERICA**

BROADCAST AND TELEVISION EQUIPMENT
CAMDEN, N. J.

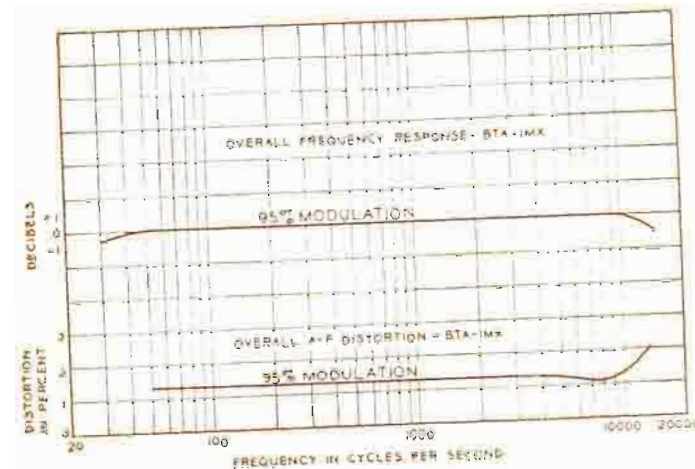

Typical BTA-1MX/500MX frequency response and distortion curves . . . AM radio at its clear, crisp best!

TOP QUALITY AT A NEW LOW PRICE!

500 WATT TYPE BTA-500MX \$3995*

1 KW Type BTA-1MX \$4685*

*Complete with operating tubes and crystal,
F.O.B. Camden, N. J.

Prices subject to change without notice.

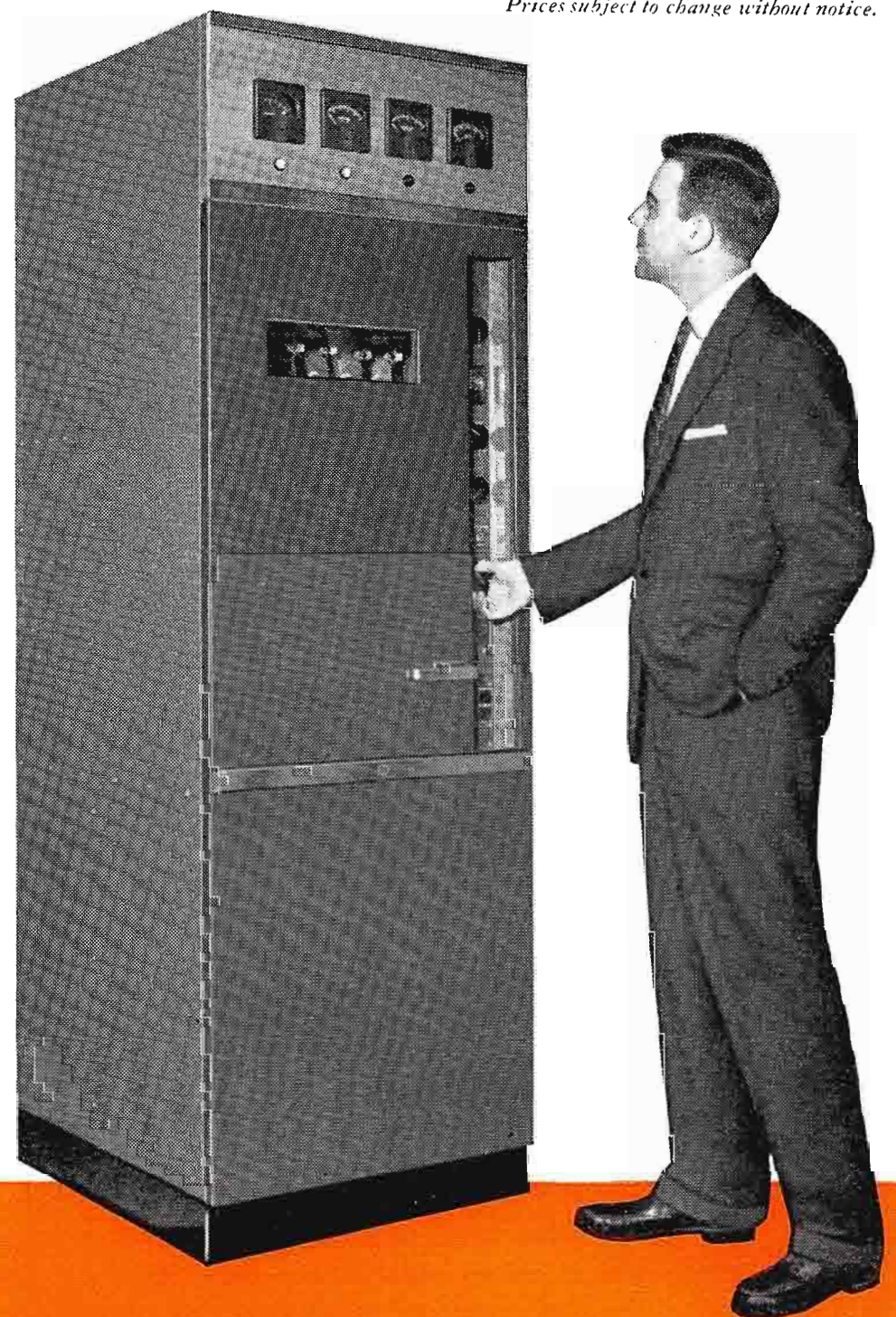

NOW

is the time to buy

color television

Color TV is here! It's right and it's ready. You can now see Color Every Night—and RCA Victor "Living Color" TV sets are now priced within the reach of every family! Here's the full story:

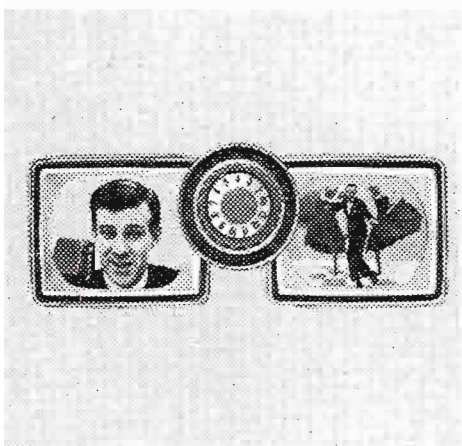

Like 2 sets in 1! You get Color and all black-and-white shows, too!

This is RCA Victor Compatible Color TV! You see all the great Color shows in "Living Color" . . . regular programs in clear, crisp black-and-white. With Big Color, you see *everything*.

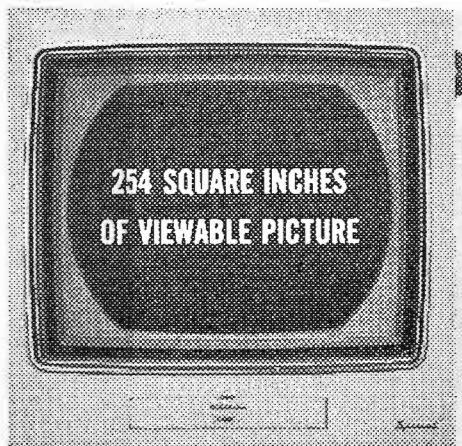

Big-as-life 21-inch picture tube—overall diameter

Actually 254 square inches of viewable picture area. And every inch a masterpiece of "Living Color." Here are the most natural tones you've ever seen—on a big-as-life screen!



Color every night — right now! Something for everyone!

You'll have "two on the aisle" for the best shows ever—drama, comedies, Spectaculars, children's shows, local telecasts. For now 216 TV stations are equipped to telecast Color.

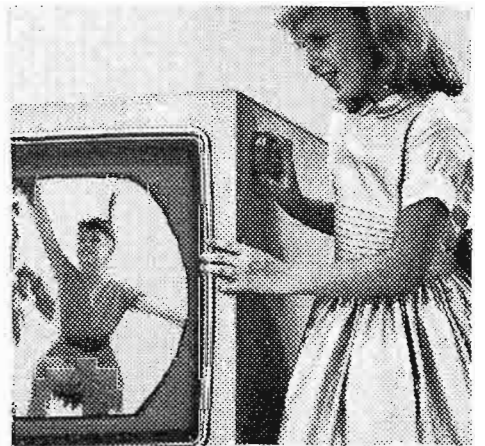

Big Color TV is so easy to tune, even a child can do it!

Turn two color knobs and there's your Big Color picture! It's easy, quick, accurate. You're in for a new thrill when the picture pops onto the screen in glowing "Living Color."

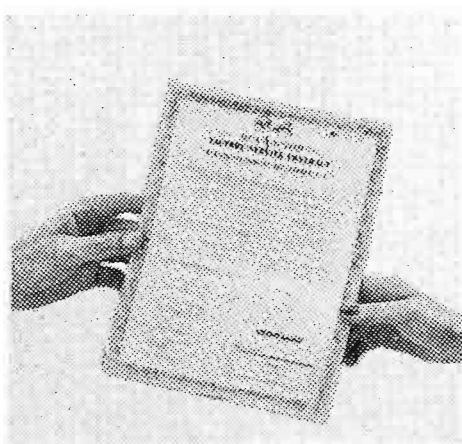

Practical and dependable! Service available at lowest cost ever!

Big Color is *dependable* Color. And RCA Factory Service is available in most areas (but only to RCA Victor TV owners) at *new low cost*. \$39.95 for installation, service for 90 days.

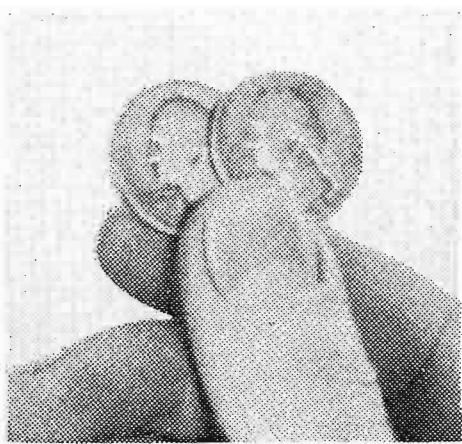

Color TV is a common-sense investment—costs only a few cents a day.

It's sure to become the standard in home entertainment for years to come—yet you can enjoy Color every night *right now!* And you can buy on easy budget terms.



Now starts at \$495—no more than once paid for black-and-white.

This is the lowest price for Big Color TV in RCA Victor history! There are 10 stunning Big Color sets to choose from—table model, console, luxurious lowboys, and consoles, too.

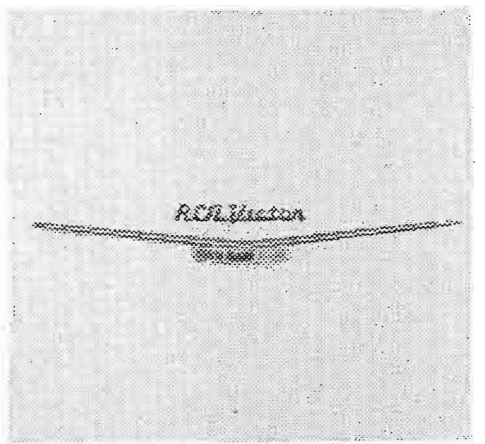

Make sure the Color TV you buy carries this symbol of quality.

RCA pioneered and developed Compatible Color television. Because of this unique experience, RCA Victor Big Color TV—like RCA Victor black-and-white—is First Choice in TV.

There will never be a better time than now to buy Big Color TV

Be among the first to enjoy television's greatest advance in 20 years

Manufacturer's nationally advertised VHF list price subject to change. UHF optional, extra.



Now...Improved VIDICONS



RCA-6326
and RCA-6326-A*

with **MICRO-MESH**
...the **RCA**
750-Mesh Screen

**New version, constructed without side tip.*

RCA-6326 and RCA-6326-A, designed for use in TV film and slide cameras—both color and black-and-white—now feature MICRO-MESH.

Micro-Mesh substantially improves the picture quality of TV film cameras—even beyond present-day high-quality performance standards. Under continuous development for more than five years at RCA, Micro-Mesh eliminates mesh pattern in black-and-white or color TV *without any need for defocusing.*

Examples of RCA's leadership in the design and manufacture of superior-quality tubes for telecasting, these vidicons are available through your RCA Tube Distributor.

For technical information on these and other RCA camera tubes, write:
RCA, Commercial Engineering, Harrison, N. J.



PICK-UP TUBES FOR TELECASTING

RADIO CORPORATION OF AMERICA

Tube Division Harrison, N. J.